



E-TYPE



Pack 11

BUILD INSTRUCTIONS

STAGE 83: ASSEMBLING THE LUGGAGE RACK

**STAGE 84: ATTACHING THE BOOT COVER
TO THE BODY**

STAGE 85: FITTING TRIM TO THE PILLARS

**STAGE 86: ATTACHING THE HUB CAPS
AND MOUNTINGS**

STAGE 87: GLASS FOR THE WINDSCREEN

STAGE 88: INSTALLING THE WINDSCREEN

**STAGE 89: MOUNTING THE WINDSCREEN
WIPERS, REAR VIEW MIRROR, FUEL TANK
COVER AND FOLDED ANTENNA**

**STAGE 90: BOOT OPENING TOOL AND
INSTALLING THE INTERIOR BACK**

Advice from the experts

Spare screws are included with each part. Occasionally, you may be instructed to keep spare or unused screws for a later stage. Keep these spares in a safe place and label them correctly.

Please make sure you don't mix up the screws. They look quite similar, but the threads do vary slightly. Using the wrong screws may damage the parts.

When securing parts together using multiple screws, fit each screw loosely to ensure all the parts are correctly aligned before gently tightening them firmly, but not overtight, in the order in which you placed them.

The screwdriver can be magnetized by stroking it with a magnet (fridge magnet, etc.) enabling it to hold the screws and make assembly easier.

If a screw is tight going into a metal part, do not force it as you may shear the head off. Remove it and put a tiny smear of Vaseline, soap or light oil on the thread. That will lubricate it and make it easier to drive home.

During the course of this build, you will receive many pieces that you will assemble immediately – following the instructions in the corresponding stage – and other pieces that you should store safely to one side, for use in future assembly stages.

Left and Right! When building your Jaguar, the left or right hand side refers to each side as you are sitting in the car.



WARNING: Some parts are assembled using magnets. These magnets can cause serious injury if they are swallowed. Keep away from children. If you suspect a magnet has been swallowed, seek medical help straight away.

Stage 83: Assembling the Luggage Rack

In this first stage, you'll build the luggage rack that can be installed on the boot of your Jaguar.



STAGE 83 PARTS LIST

Name
Left luggage rack holder
Right luggage rack holder
Luggage rack
Screws type AG01 x3

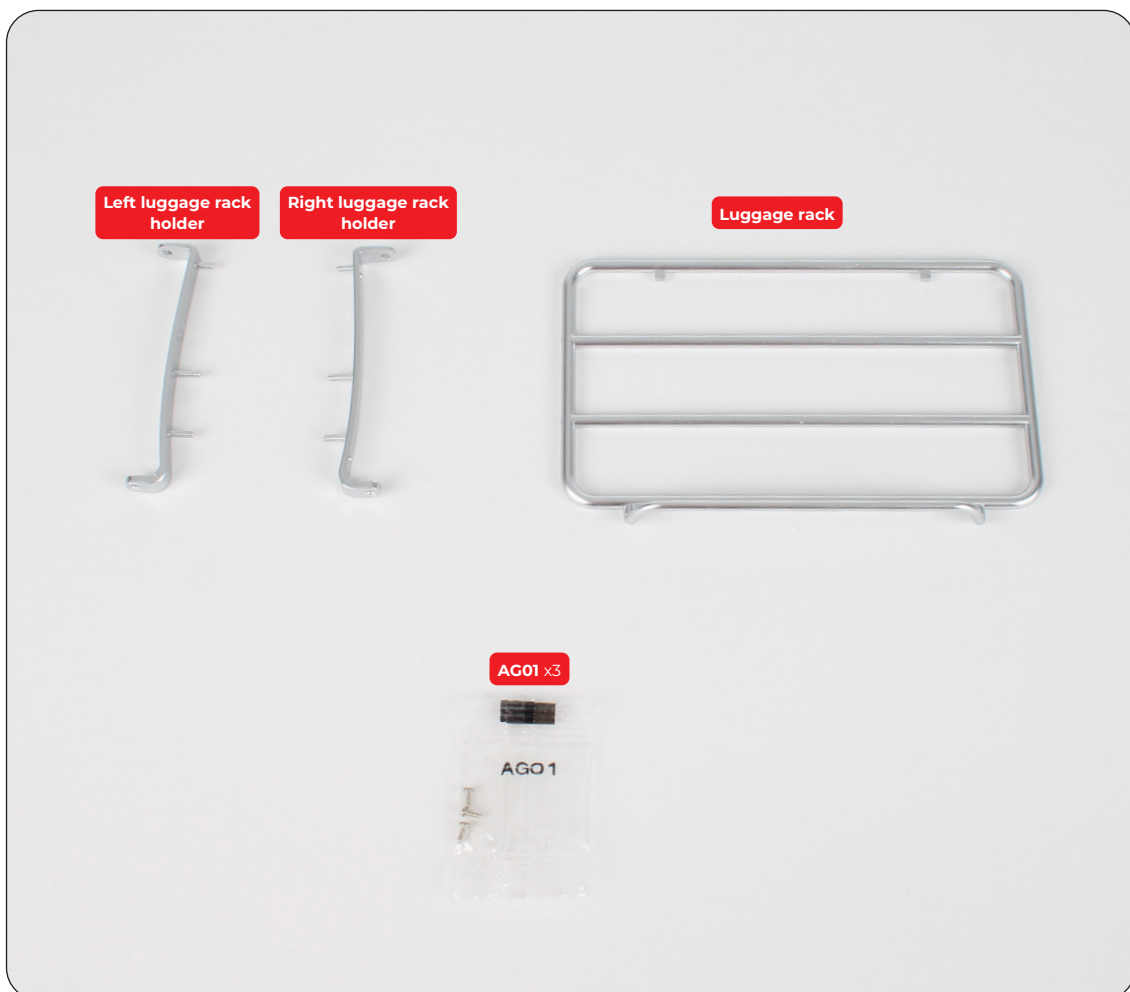

Stage 83: Assembling the Luggage Rack

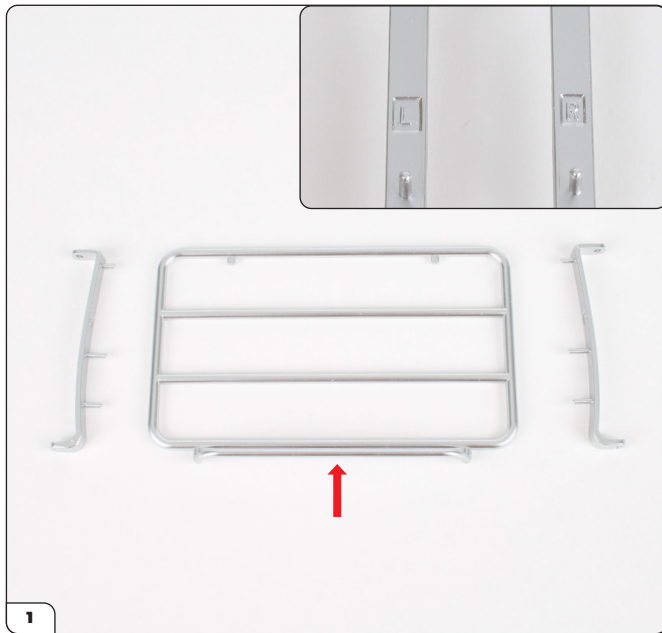

1
Align the left and right luggage rack holders (marked 'L' and 'R', inset) with the luggage rack, with the lip of the luggage rack (arrow) facing you as shown.

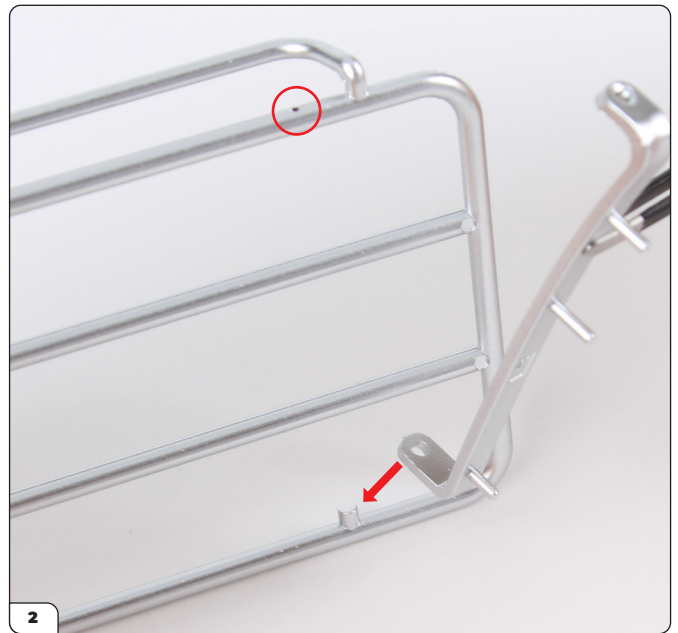

2
Lift the luggage rack and take the right holder. Insert the D-shaped hole on the holder over the corresponding pin on the rack (arrow). Note the small screw hole (circled) at the top of the rack.

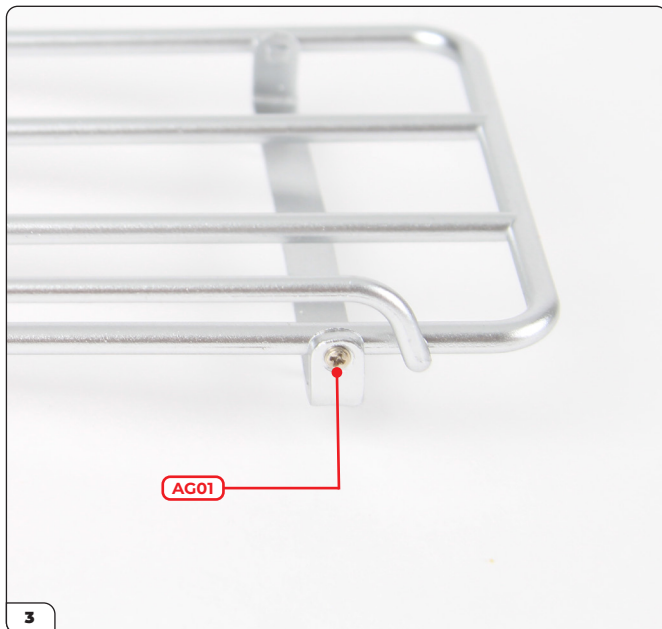

3
Align the other end of the holder with the small screw hole, then fix in place using an AG01 screw.



4
Repeat step 2 for the left luggage rack holder and fix in place with an AG01 screw.

Stage 83: Assembling the Luggage Rack

STAGE COMPLETE

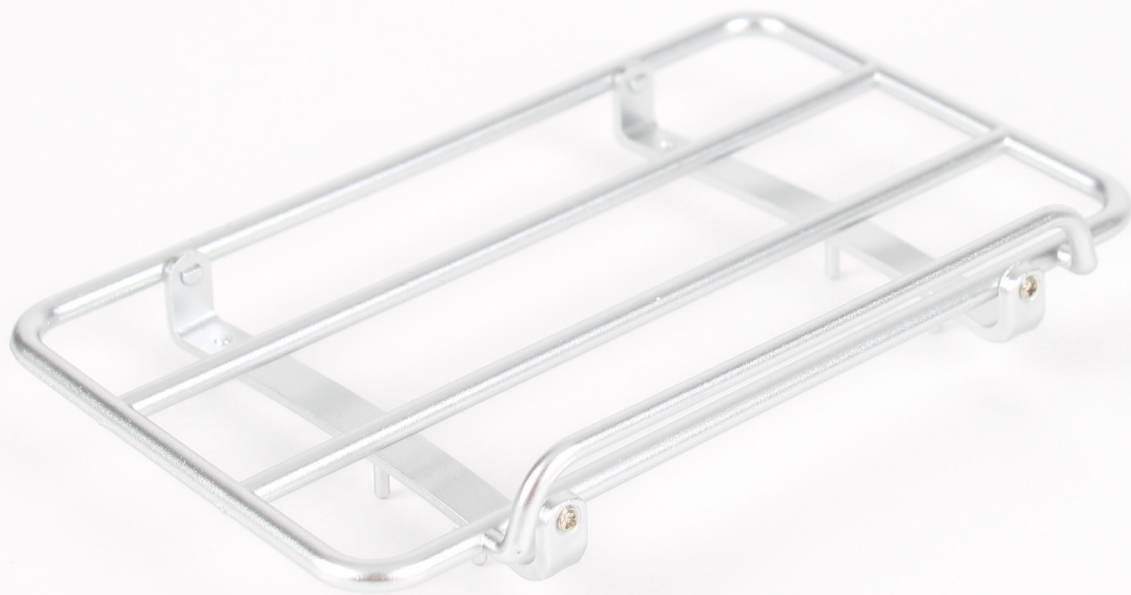

Optional: Fitting the Luggage Rack

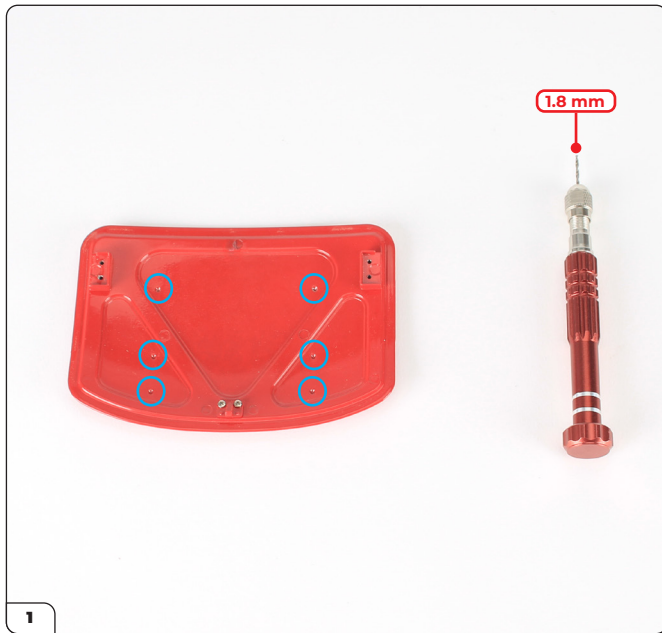

To attach the luggage rack you'll need a 1.8 mm bit and drill. Locate the six areas to drill through marked on the underside of the boot cover (circled).



Lay the boot cover from Stage 82 on a protective surface. We used a piece of foam so that the drill can pass through without damaging the work area beneath.



Start by drilling through from the underside of the boot cover as shown. Once the drill bit has started to pierce through to the other side (inset), we recommend turning the cover over and drilling from the topside of the cover to get a clean finish.



Turn the boot cover over and drill from the topside to get a clean finish on the hole. Repeat these steps for all six of the holes highlighted in the first step.

Use a damp cloth to carefully pick away any of the shavings left from drilling so that the surface of the boot cover doesn't get scratched.

Optional: Fitting the Luggage Rack



Once all six holes have been drilled, align the luggage rack with the boot cover as shown and fit into place.



The luggage rack will stay in place without the need to glue it.

STAGE COMPLETE



Stage 84: Attaching the Boot Cover to the Body

Next you'll start work on the body of the car. You'll need the boot cover assembly and two mounting plates from Stage 82.

Be careful when unpacking to avoid scratching the paintwork, and use a protective surface while building to keep the body safe!



STAGE 84 PARTS LIST

Name
Body
Screws type AM12 x5



Stage 84: Attaching the Boot Cover to the Body



After unpacking the body, place it on a protective surface while you work. Here we have laid the body upside down and used the polystyrene packaging as a makeshift stand to avoid any scratches.



Take the boot cover assembly from Stage 82. Carefully insert the hinges of the boot cover from underneath, through the opening in the body as shown.



Fit the hinges into the recesses on the body (circled) and press the boot cover closed, so that the catch clicks in place (arrow).



With the boot cover held closed, fit the mounting plates from Stage 82. Note the 'L' and 'R' on the parts (inset), then take the left mounting plate and align it with the recess as shown. The small pin fits into the small hole (arrow).

Stage 84: Attaching the Boot Cover to the Body

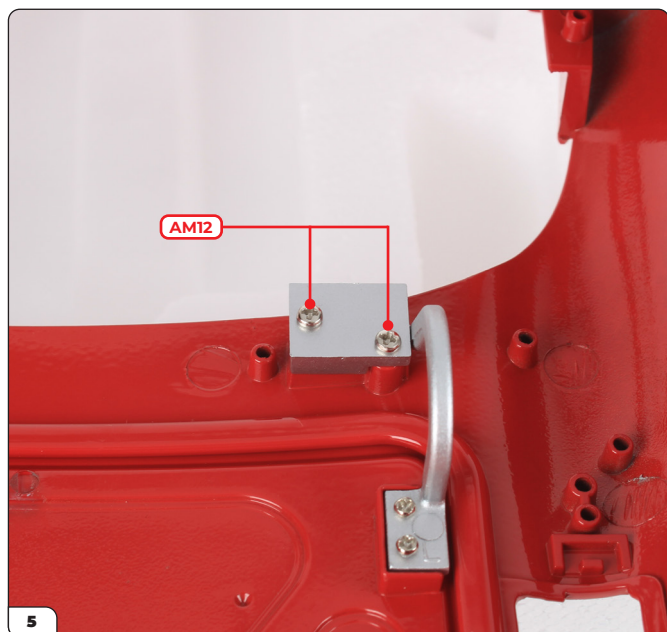

Attach the mounting plate by driving through 2x AM12 screws.



Repeat step 4 to fit the right mounting plate on the other side and fix in place with 2x AM12 screws.



Stage 85: Fitting Trim to the Pillars

You'll fit the interior trim for the pillars in this stage. You may wish to super glue the trim to the pillar to make sure the fit is flush.



STAGE 85 PARTS LIST

Name
Left side pillar trim
Right side pillar trim
Screws type AM05 x3
Screws type AG10 x3



Stage 85: Fitting Trim to the Pillars

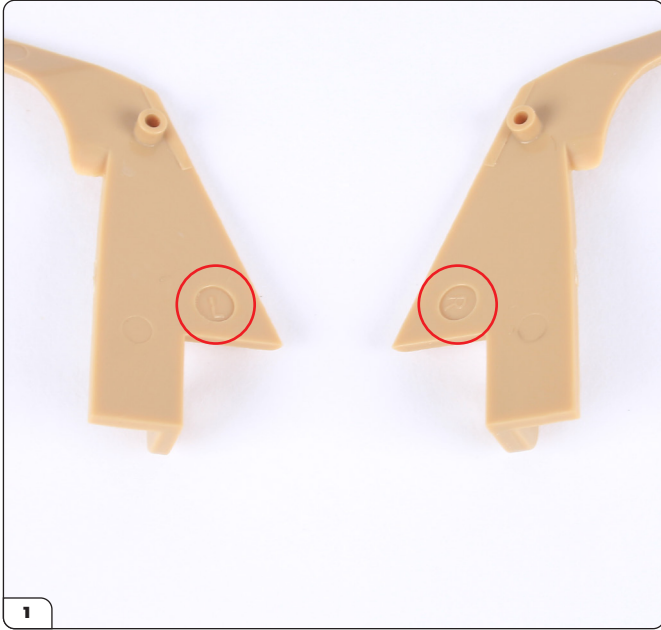

Identify the left pillar trim from the right pillar trim by finding the 'L' and 'R' printed on the parts (circled).

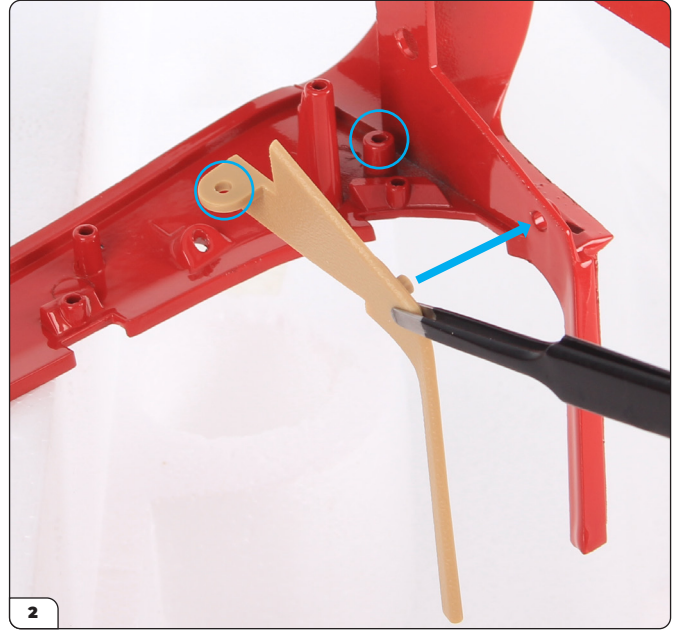

Take the left pillar trim and align it with left side of the body as shown. The lug on the trim fits into the hole in the pillar (arrow), while the screw hole on the trim sits over the corresponding raised screw socket on the body (circled).



Fit the trim in place so that it sits flush against the pillar. You may wish to apply a small amount of super glue to the thin end of the trim to hold it in place (arrow).



Locate the screw hole on the opposite side of the pillar and drive an AG10 screw through.

Stage 85: Fitting Trim to the Pillars

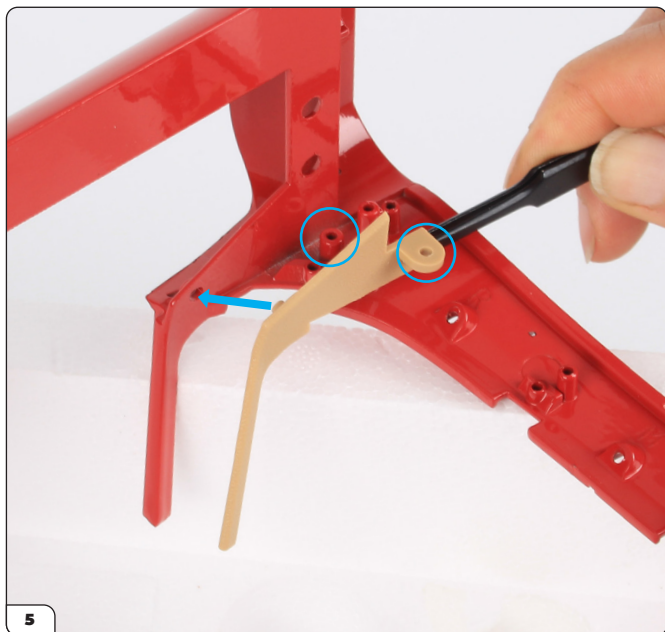

Now fit the right pillar trim in place in the same way as the left one.

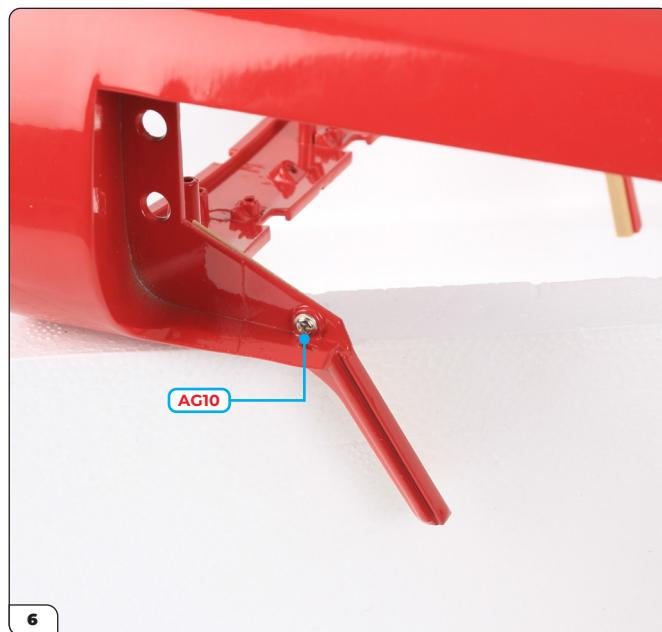

Attach the right trim with an AG10 screw.

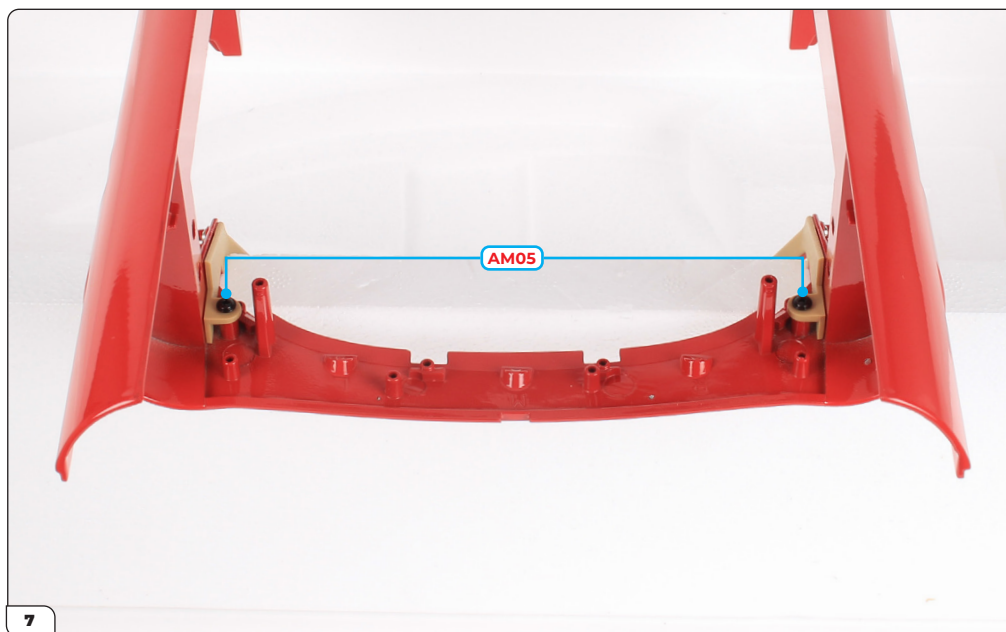

Drive 2x AM05 screws through the two pillar trims to secure them in place.

Stage 85: Fitting Trim to the Pillars

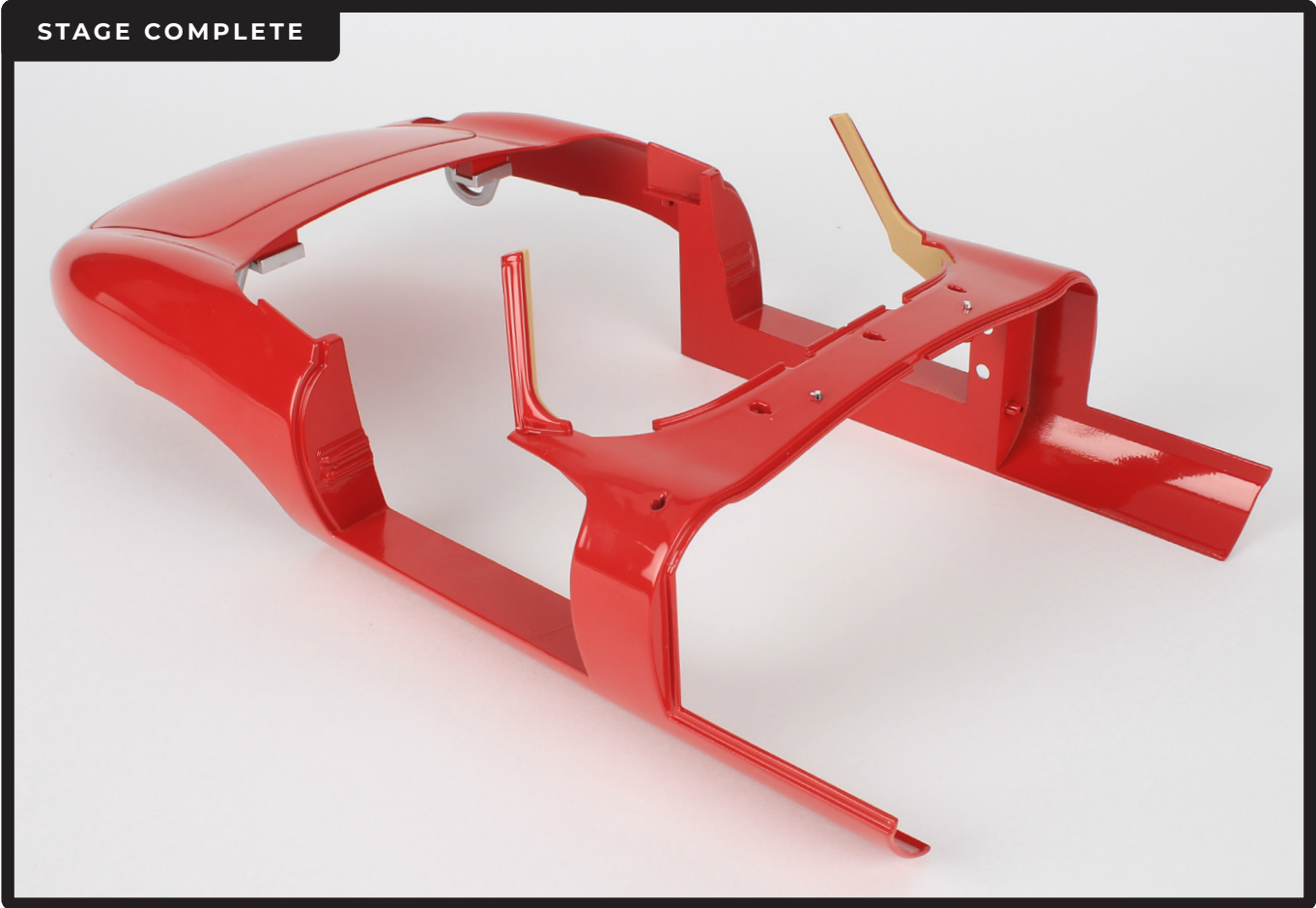

Stage 86: Attaching the Hub Caps and Mountings

The next stage adds mounting plates for the front of the car onto the body. You'll also attach the hub caps to the wheels, which snap in place with magnets.

You'll need the hub cap supplied in Stage 23, as well as the front and back assemblies.



STAGE 86 PARTS LIST

Name
Left body mounting
Right body mounting
Left front car mounting
Right front car mounting
Left hand hub cap
Right hand hub cap x2
Screws type AM01 x11

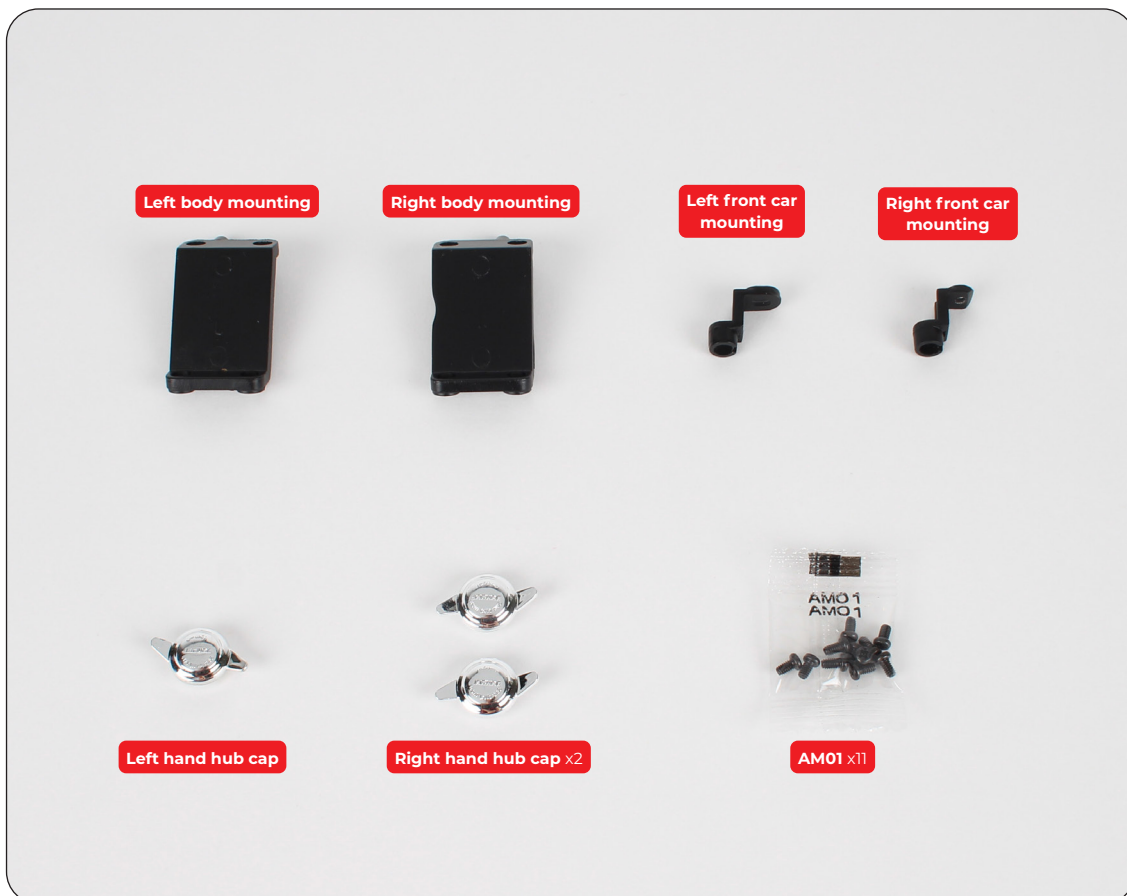

Stage 86: Attaching the Hub Caps and Mountings

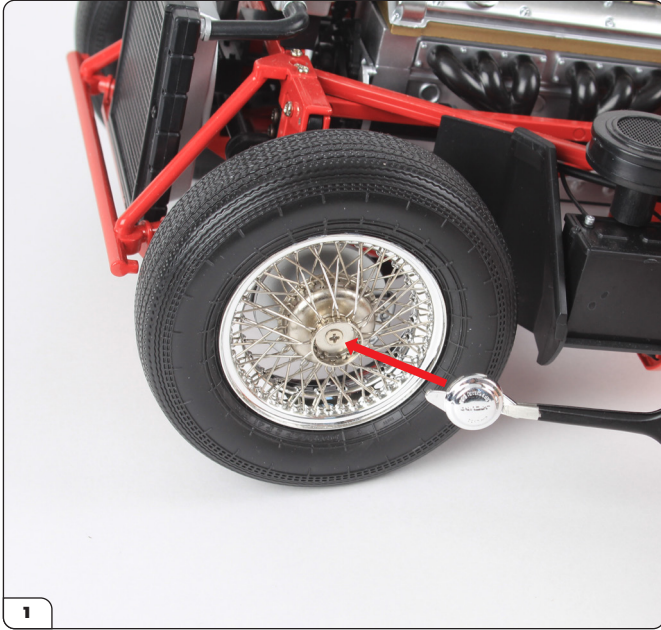

Take the left hand hub cap supplied with Stage 23 and align it with the front left wheel.

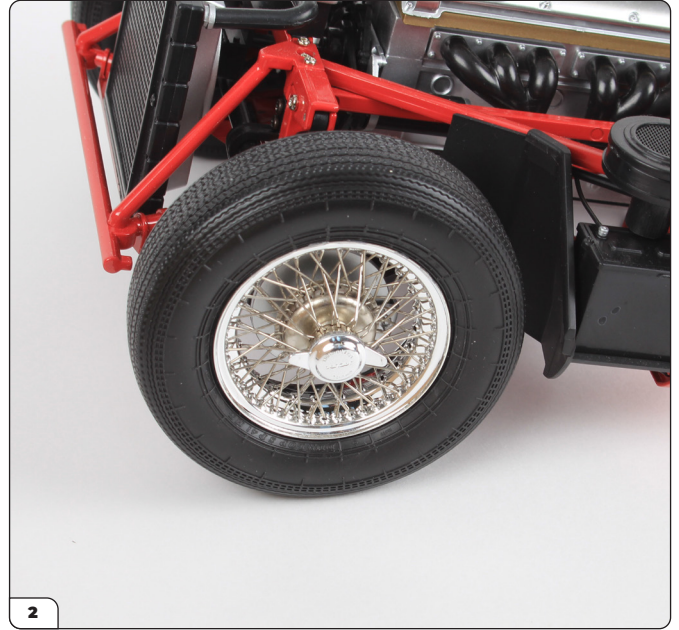

Place the hub cap over the centre of the wheel. The magnet should snap into the correct position.

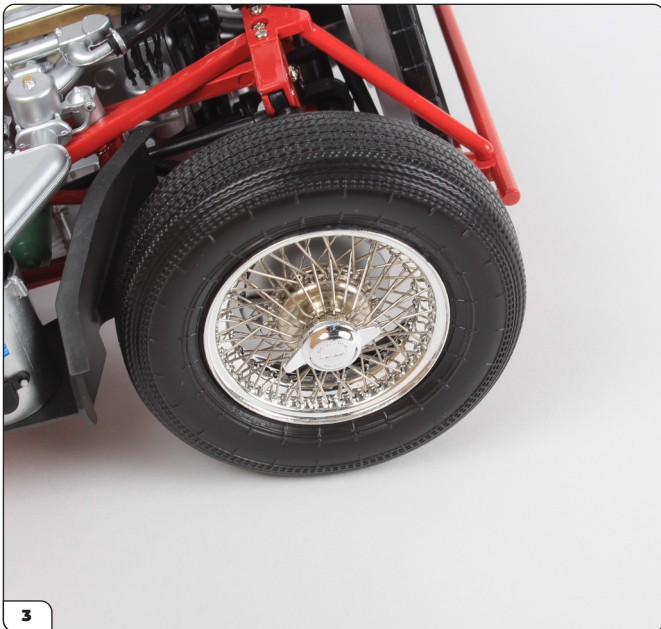

Take one of the right hand hub caps (marked 'R' on the packaging) and fit it onto the front right wheel.



Repeat to attach the remaining left ('L') and right ('R') hub caps to the rear wheels.

Stage 86: Attaching the Hub Caps and Mountings



Next take the left and right body mounting. Note the 'L' and 'R' (circled) printed on the parts. The right body mounting also has a small indent (arrow).

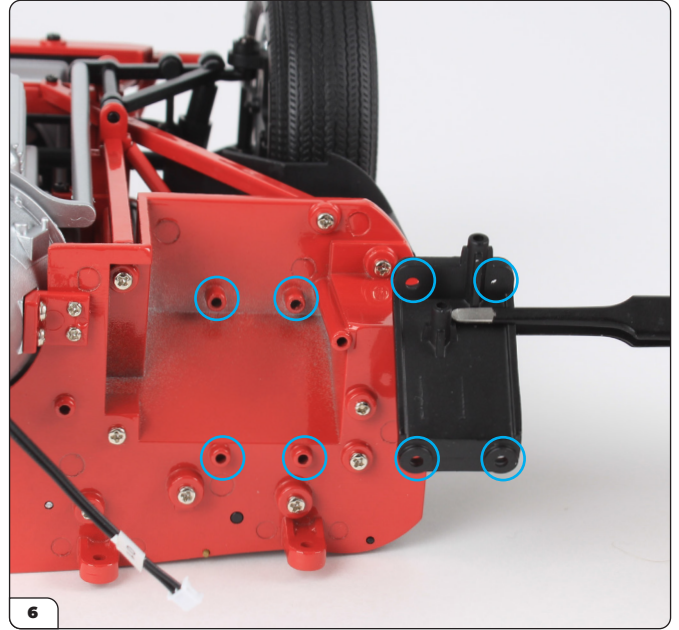

Align the left mounting plate with the front car assembly. Note the screw holes on the mounting correspond to the screw pillars protruding from the body (circled).

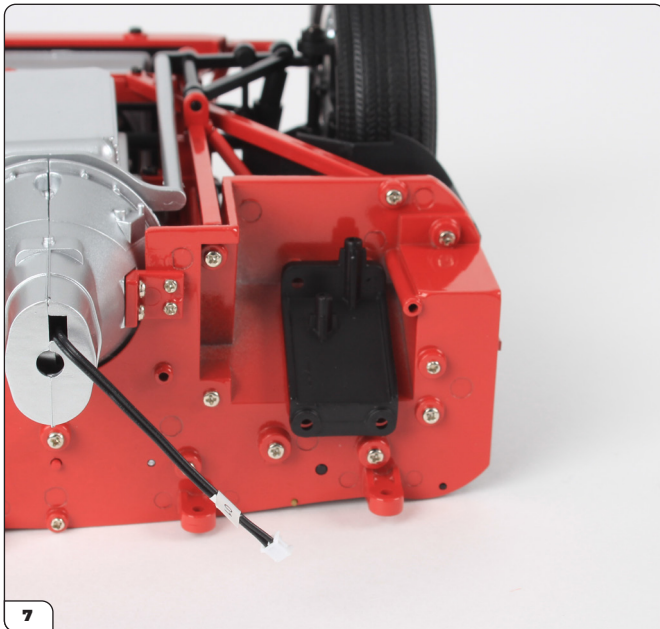

Fit the mounting plate onto the body so that all of the screw holes are aligned as shown.

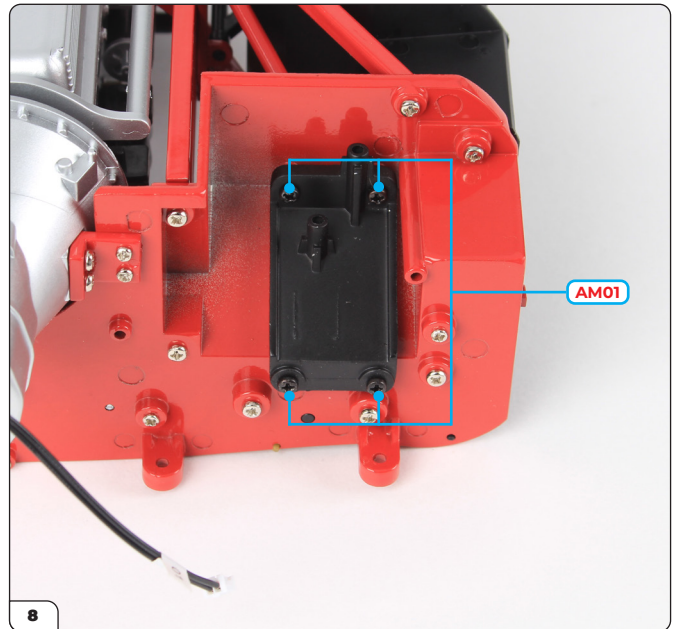

Secure the plate in place using four AM01 screws.

Stage 86: Attaching the Hub Caps and Mountings

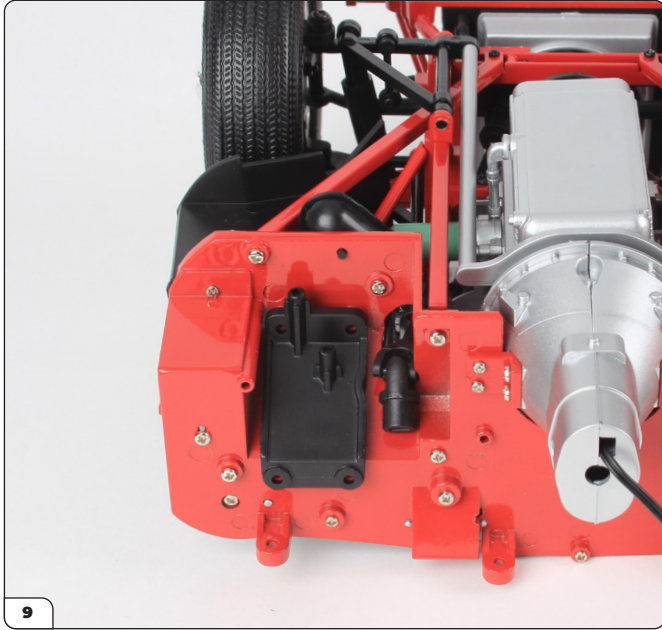

Now align the right mounting plate and fit it in place on the other side of the body as shown.

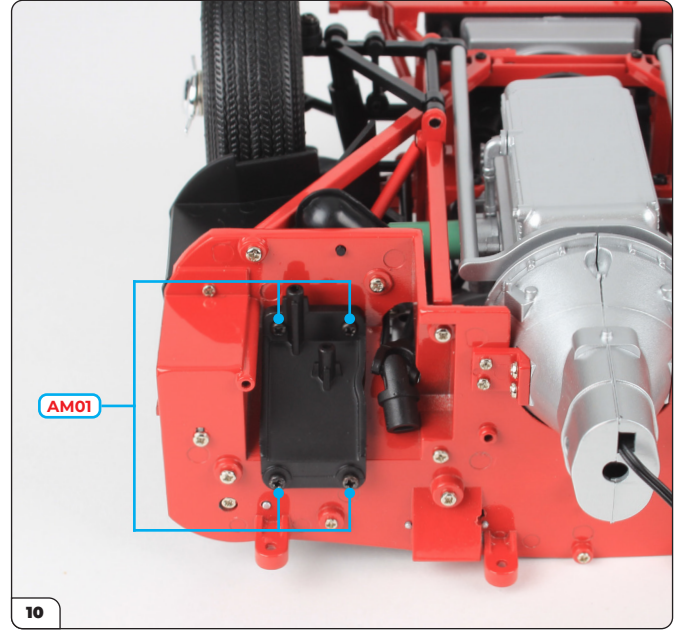

Secure the plate using 4x AM01 screws.

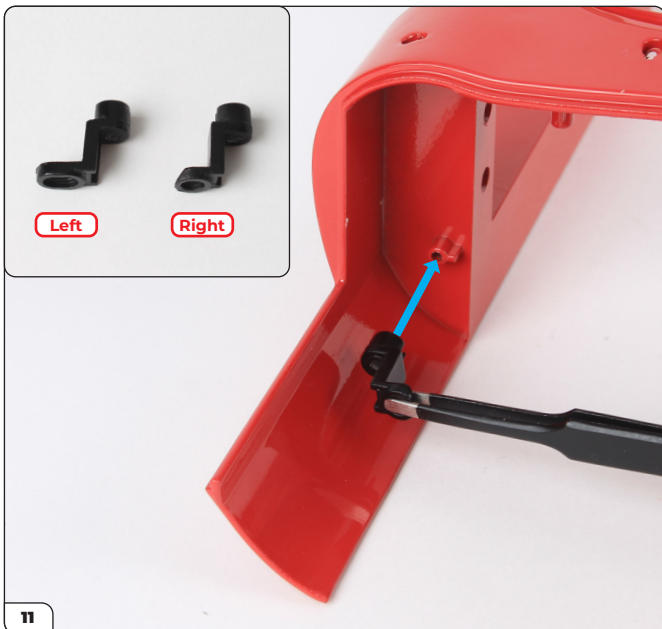

Take the right front car mounting and fit the thicker end over the shaped plug at the front of the car body as shown. Note that the right mounting has a shorter fixing point than the left mounting (inset).

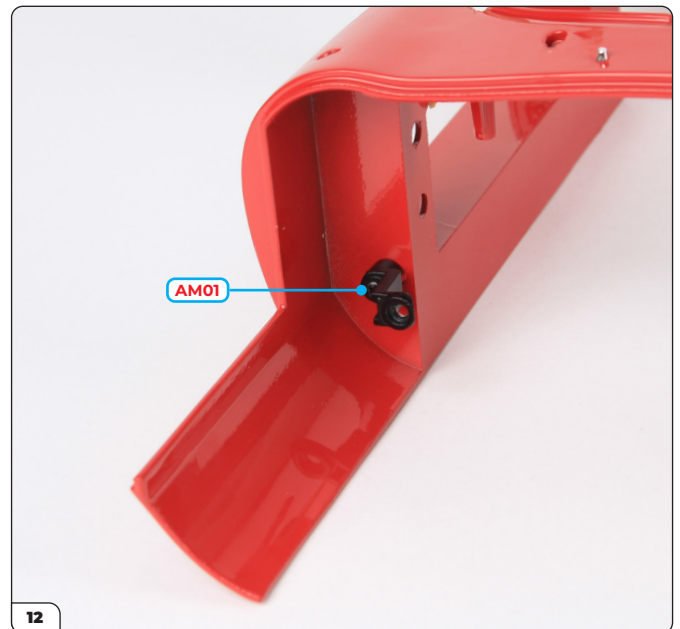

Holding it in place, secure the mounting to the body using an AM01 screw.

You may wish to leave this mounting unattached until completing Stage 89, as it helps with screwing the antenna in place. Store the mounting and the AM01 screws away safely if you do not attach it at this point.

Stage 86: Attaching the Hub Caps and Mountings



Fit the left front car mounting using the shaped plug as a guide in the same manner, then secure in place with an AM01 screw.

STAGE COMPLETE



By putting the flooring in place and gathering all the assemblies together, you can see the Jaguar start to take shape!

Stage 87: Glass for the Windscreen

There is no assembly for this stage, carefully unpack the windscreen glass and move on to Stage 88.



STAGE 87 PARTS LIST

Name
Windscreen glass



Stage 88: Installing the Windscreen

In this stage you'll fit the windscreen onto your Jaguar using the glass supplied previously and the parts from this stage.

You'll need a rubber-headed hammer for this, or cover a hammer with a rubber tip. When using the hammer, take care to tap gently so you do not bend the frame.



STAGE 88 PARTS LIST

Name
Windscreen frame
Bush x2
Screws type AM05 x3



Stage 88: Installing the Windscreen



Take the windscreen frame and align the four sets of teeth with the body facing you as shown. Tilt the frame towards you as you lower it into position.



Fit the frame so that the middle two sets of teeth connect to the corresponding screw holes under the body.

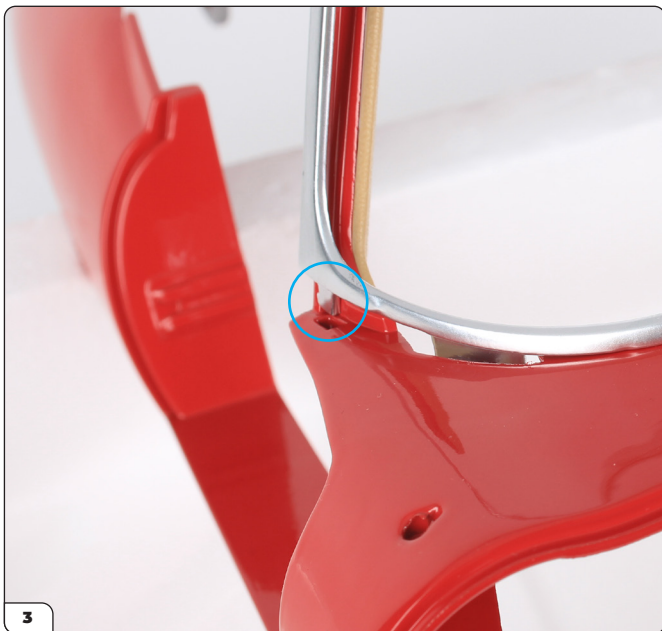

The plugs at either end of the frame should rest above the holes as shown (circled).



Take the windscreen glass and carefully fit it between the frame and the pillars.

Stage 88: Installing the Windscreen



Lower the glass into place until it is in line with the frame.



Firmly press down on either end of the frame so that the plugs are resting in their hole (circled).



Ensure the body is on a solid surface with protective layer underneath it. Then take a rubber mallet, or a suitable alternative.



Firmly pinch together the edge of the frame and the pillars of the body as shown, then gently hammer the frame at each end until the raised plugs slot into the holes.

Stage 88: Installing the Windscreen



Press around the top of the windscreen glass to make sure it is fitting in the frame correctly.



Cut the two bushes from their sprue using sprue cutters. Insert an AM05 screw through the rounded face of each bush as shown (inset).

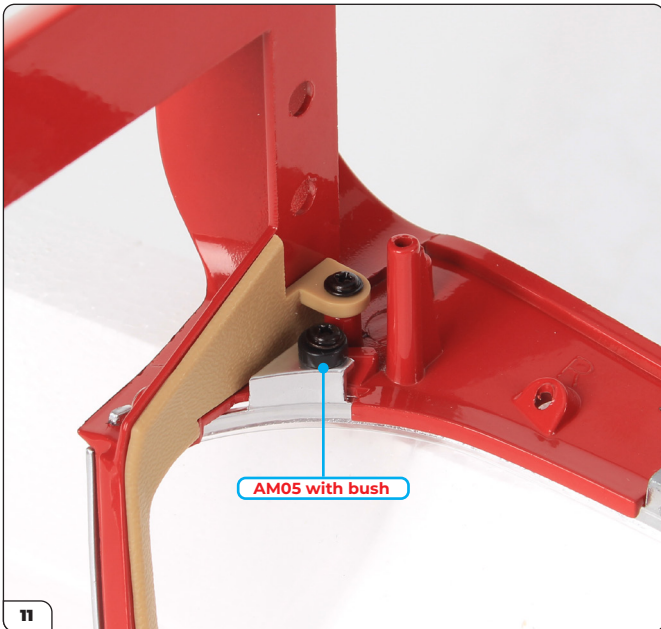

Turn the body over to reveal the underside and locate the right hand side set of teeth of the windscreen frame, next to the pillar trims. Drive an AM05 screw and bush into the hole.

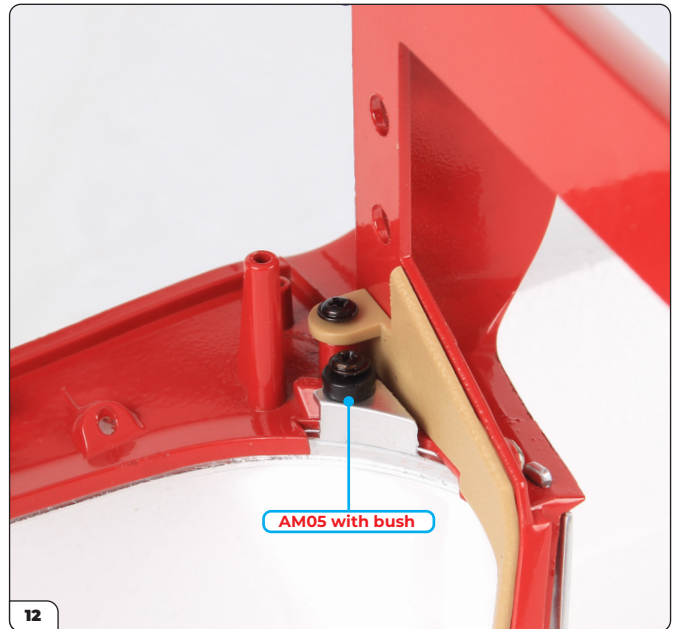

Repeat for the left hand side set of teeth to hold the frame in place.

Stage 88: Installing the Windscreen

STAGE COMPLETE



Stage 89: Mounting the Windscreen Wipers, Rear View Mirror, Fuel Tank Cover and Folded Antenna

Next you'll attach the windscreen wipers along with the rear view mirror, the fuel tank cap and the folded radio antenna to the body.



STAGE 89 PARTS LIST

Name
Rear view mirror holding rod
Windscreen wiper (left)
Windscreen wiper (middle)
Windscreen wiper (right)
Fuel tank cover
Fuel tank cover holder
Rear view mirror
Folded antenna
Rear view mirror sticker
Screws type AM01 x2
Screws type AG02 x5

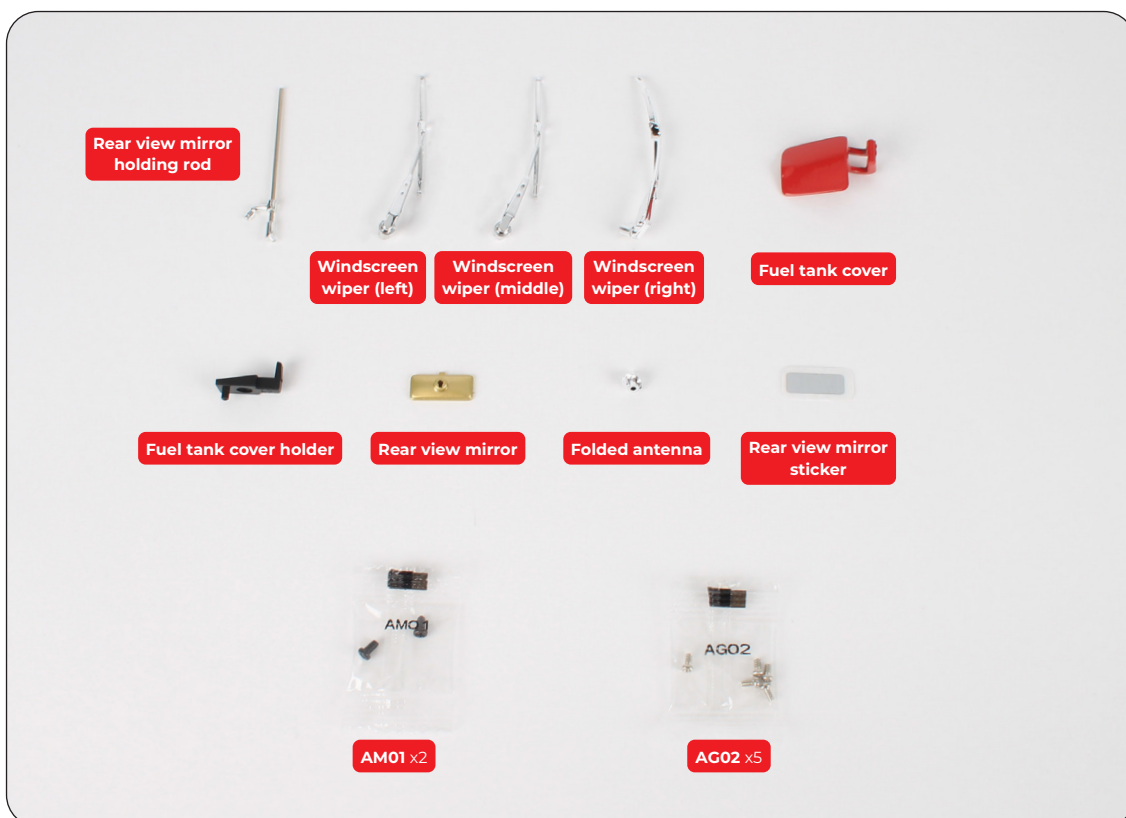

Stage 89: Mounting the Windscreen Wipers, Rear View Mirror, Fuel Tank Cover and Folded Antenna



Take the rear view mirror and its sticker. The sticker has a layer of protective film on the front and white backing paper.

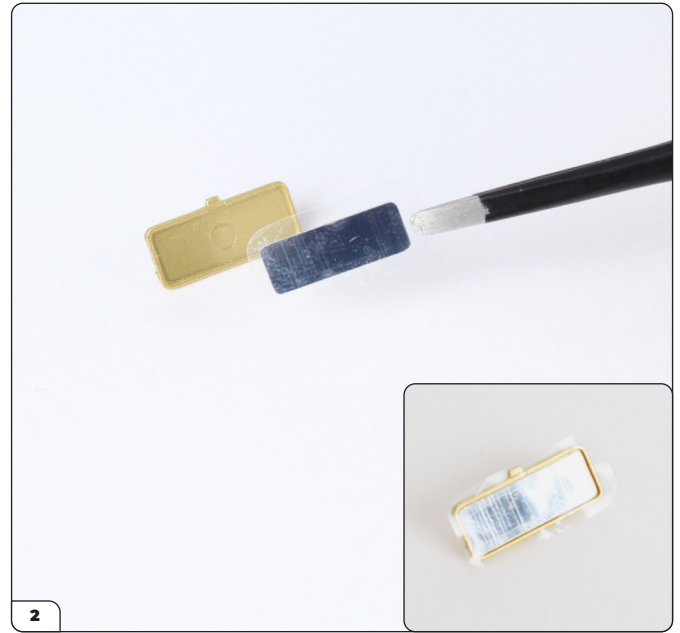

Remove the white backing paper from the sticker to reveal the adhesive. Align with the rear view mirror then press the sticker into the recess (inset).

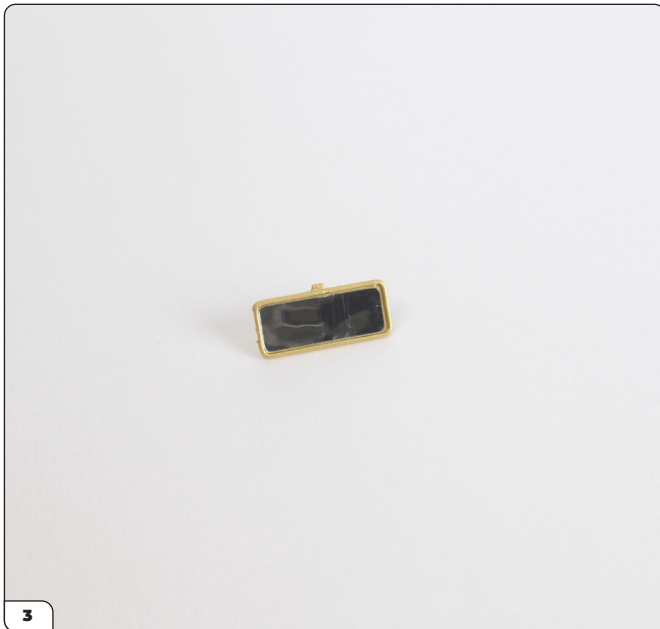

After it has been stuck in place, peel the protective film from the mirror sticker.



Turn the mirror face down, then take the mirror holding rod. Fit the curved part of the rod into the keyhole-shaped slot on the back of the mirror (arrow). The inset shows the rod fitted in place.

Stage 89: Mounting the Windscreen Wipers, Rear View Mirror, Fuel Tank Cover and Folded Antenna

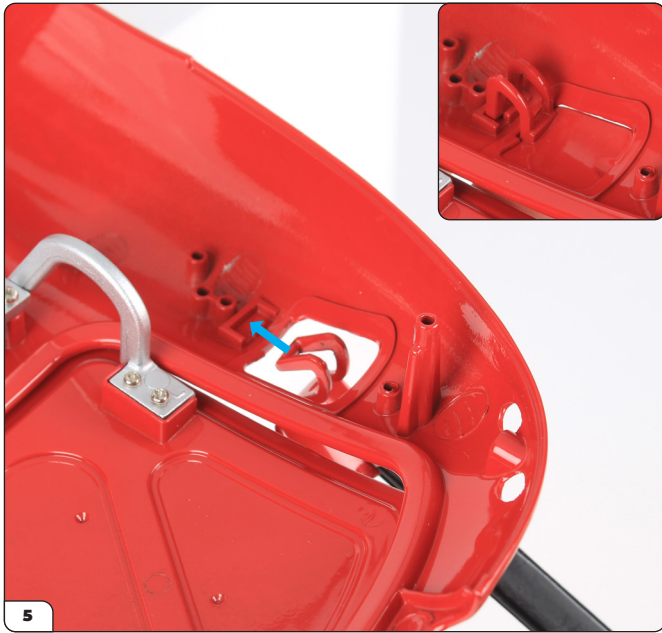

Next take the fuel tank cover and the fuel tank cover holder. Feed the hinge of the cover through the opening next to the boot as shown (arrow). Fit the end of the hinge into the recess (inset).



Holding the cover in place, slot the fuel tank cover holder into position. The screw hole should sit over the top of the circled socket in the body.

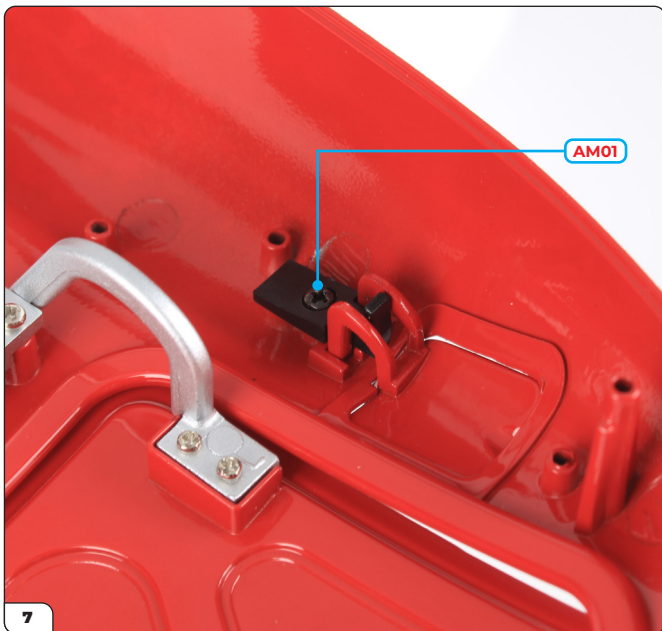

Use an AM01 screw to attach the holder.

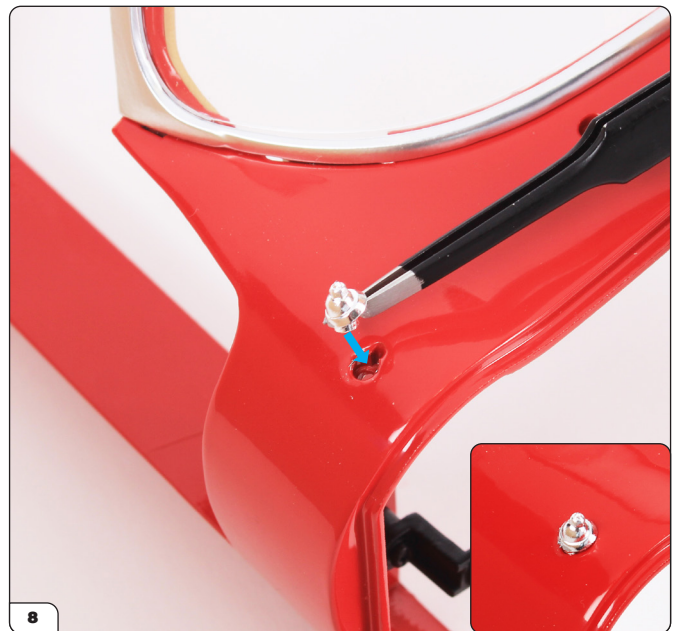

Next fit the folded antenna into the keyhole-shaped recess on the right hand side of the body. Firmly press it into place (inset).

Stage 89: Mounting the Windscreen Wipers, Rear View Mirror, Fuel Tank Cover and Folded Antenna

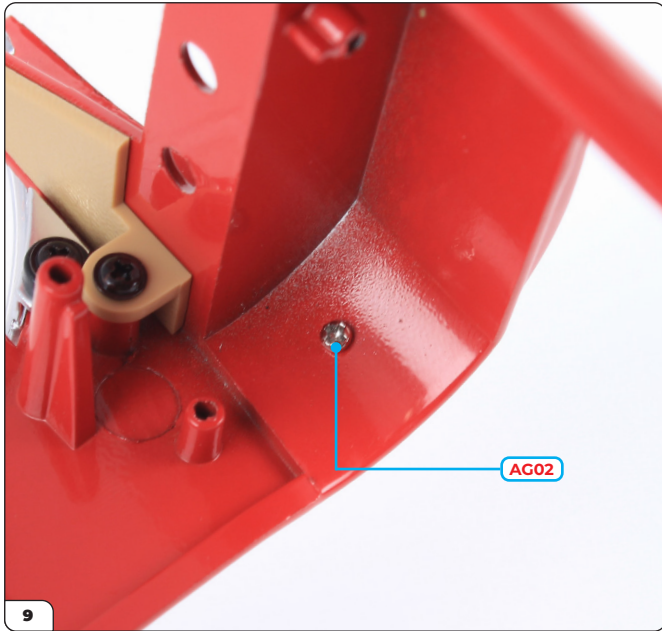

Carefully turn the body over and fix the antenna using an AG02 screw.

Driving this screw in can be difficult, try removing the right front car mount as we have done in the photo if needed.



Now take the windscreen wipers. Identify the left, middle and right wiper by checking the 'L', 'M' and 'R' printed on the parts (circled).

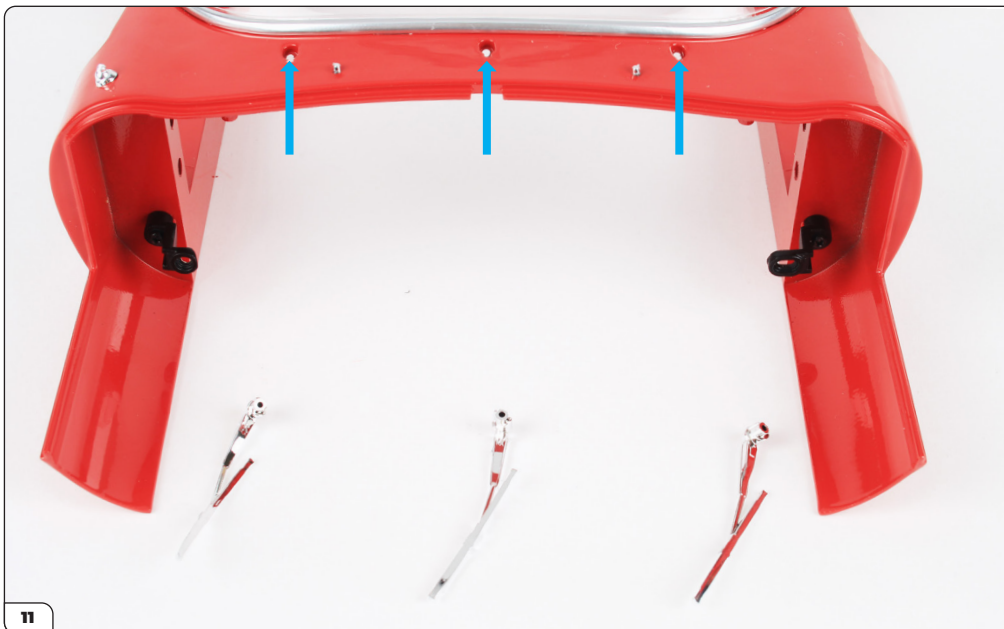

Match the wipers to the corresponding holes in the front of the windscreen.

Note: the holes also have 'L', 'M' and 'R' marked above to them on the underside of the body (see photo 14).

Stage 89: Mounting the Windscreen Wipers, Rear View Mirror, Fuel Tank Cover and Folded Antenna



Push the plug on the left windscreen wiper into its corresponding hole. Position the wiper so that the blade is parallel with the windscreen frame (inset).

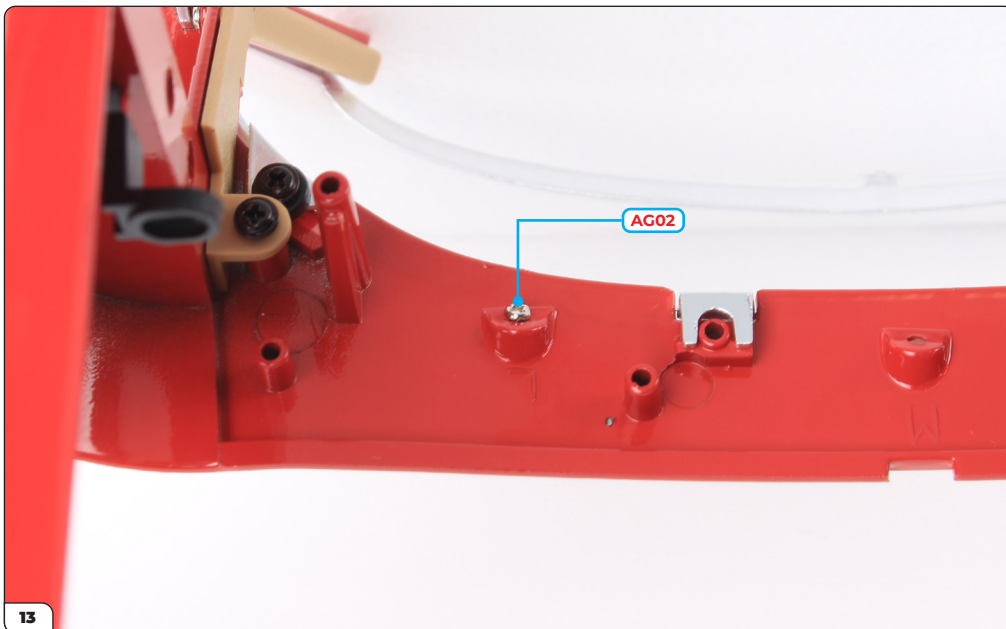

Turn the body over and secure the wiper in place with an AG02 screw.

Stage 89: Mounting the Windscreen Wipers, Rear View Mirror, Fuel Tank Cover and Folded Antenna

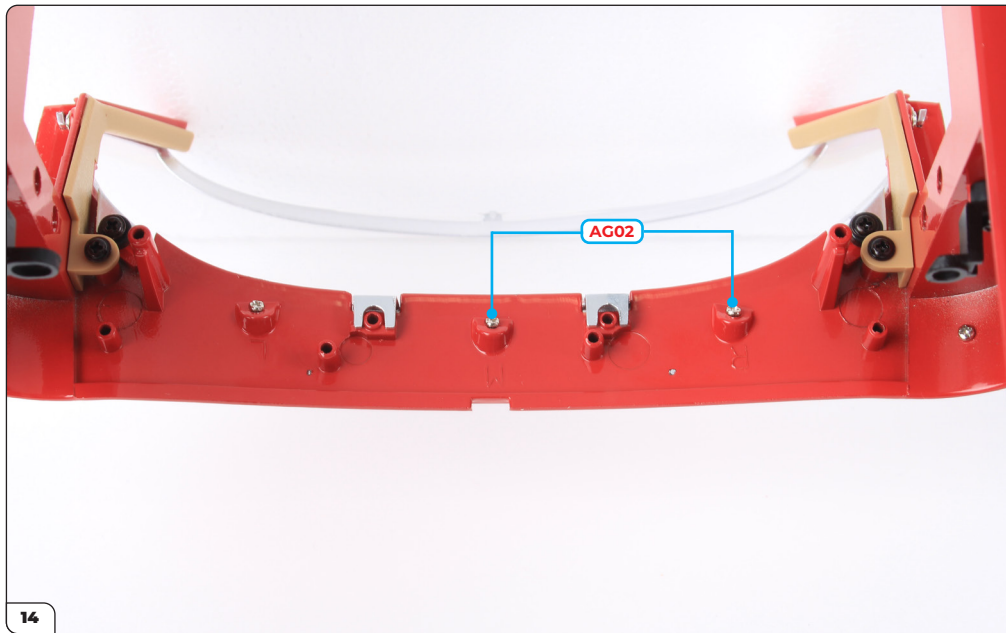

Fit the middle 'M' and right 'R' wipers in place in the same manner and secure them with 2x AG02 screws.



The windscreen wipers should look like this when correctly fitted.

Stage 89: Mounting the Windscreen Wipers, Rear View Mirror, Fuel Tank Cover and Folded Antenna

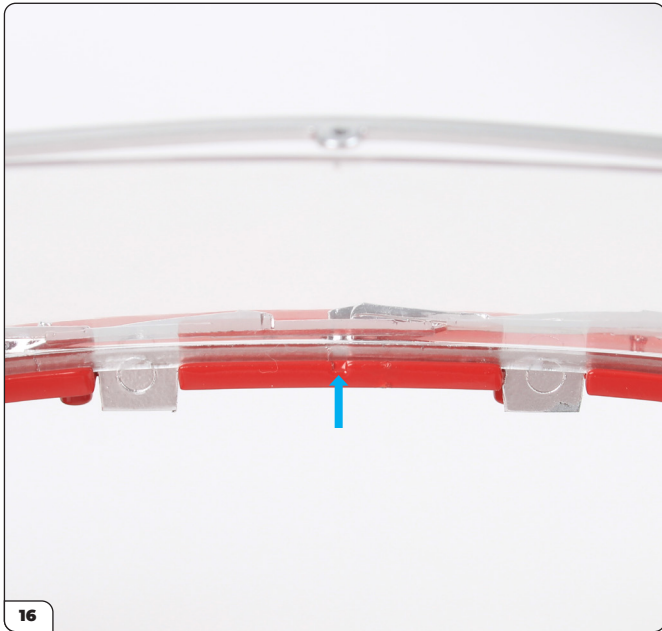

Turn the body the correct way up. In the middle of the joint between the windscreen frame and body, locate the small notch (arrow). This will be important when fitting the rear view mirror in place.

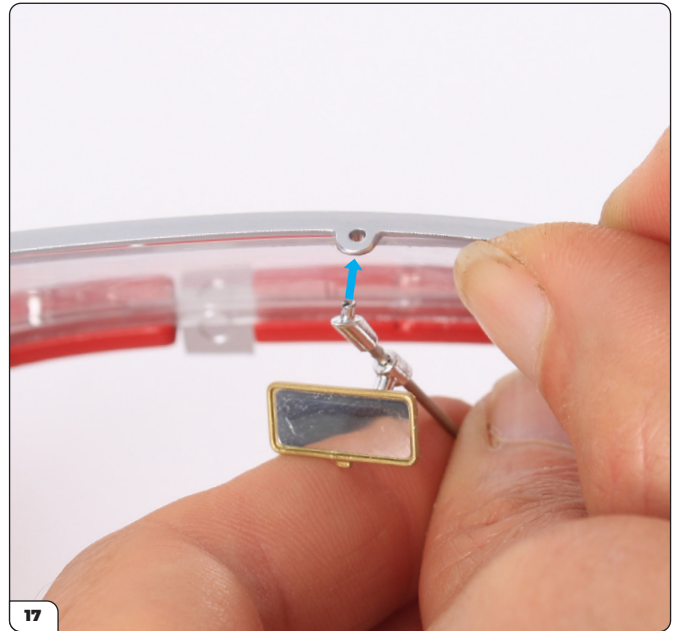

Take the rear view mirror holding rod and fit the small peg into the hole at the top of the windscreen frame (arrow).

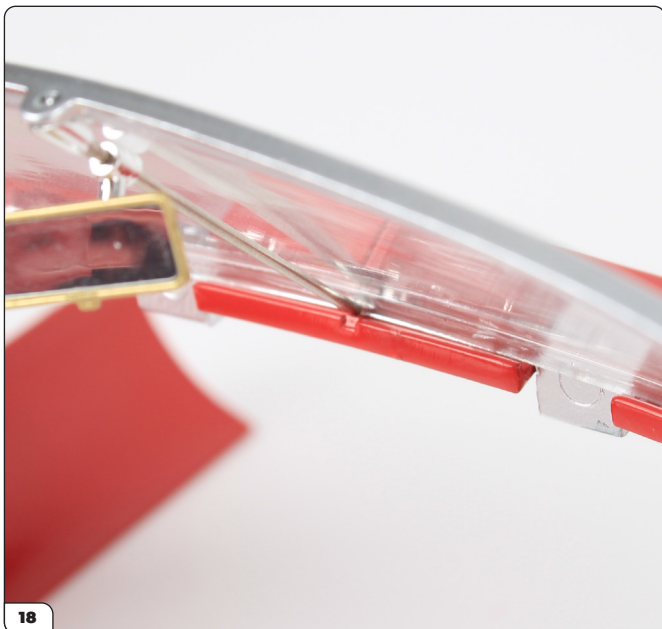

Once the peg is in place, carefully guide the other end of the rod into the small notch you located in step 16.

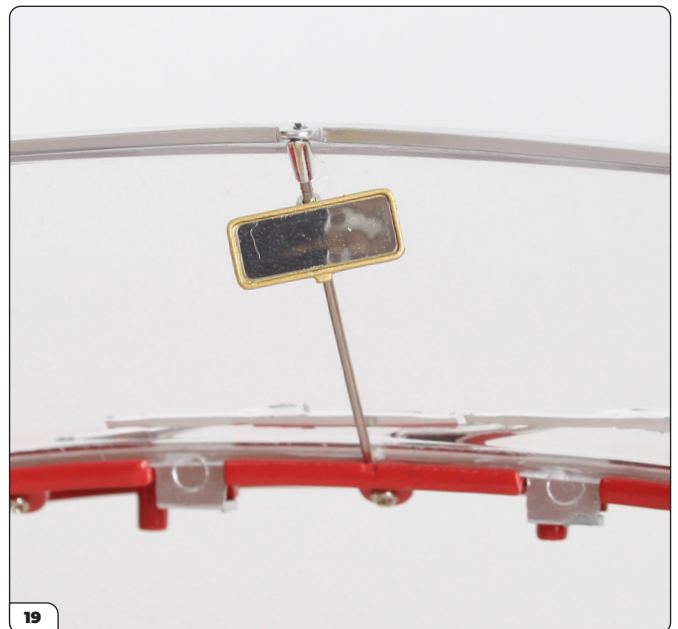

The rear view mirror will be held in place by the tension in the rod. Do not glue these parts as this may frost the glass of the windscreen.

Stage 89: Mounting the Windscreen Wipers, Rear View Mirror, Fuel Tank Cover and Folded Antenna

STAGE COMPLETE



Stage 90: Boot Opening Tool and Installing the Interior Back

In the last stage of this Pack you'll fit the back of the interior behind the seats of the cockpit.

You'll also be supplied with a boot opening tool, which can be used for lifting up the boot without risking scratches to the paintwork.



STAGE 90 PARTS LIST

Name
Interior back
Boot opening tool
Screws type AG02 x3



Stage 90: Boot Opening Tool and Installing the Interior Back

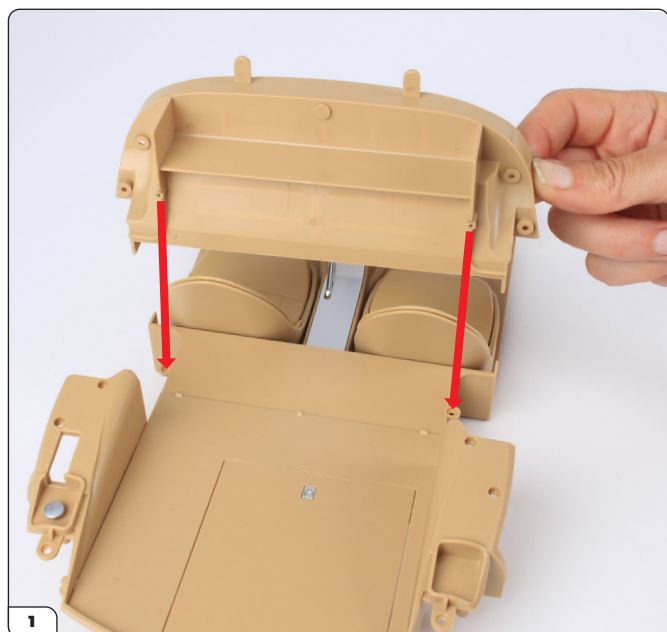

Take the interior assembly from Stage 70. Align the interior back with the area behind the seats as shown. Note the screw holes that need to be lined up when fitting (arrows).



Place the interior back behind the seats. Note the three notches that help to hold it in the correct position (arrows).



While holding everything together, turn the assembly over and drive 2x AG02 screws in to secure the interior back in place.

Stage 90: Boot Opening Tool and Installing the Interior Back

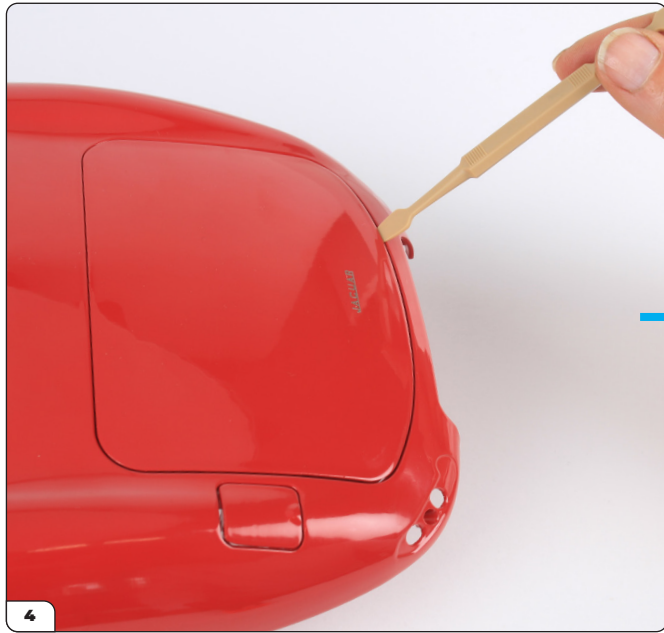

To use the boot opening tool, gently push the wedged end of the tool into the gap as shown, then use it to lever the lid and lift it open.

STAGE COMPLETE

