



E-TYPE



Pack 10

BUILD INSTRUCTIONS

**STAGE 74: RIGHT-HAND HEADLIGHT COVER
AND VALANCE**

**STAGE 75: LEFT-HAND HEADLIGHT COVER
AND VALANCE**

STAGE 76: ATTACHING THE STONE GUARD

STAGE 77: THE FRONT UNDERPANEL

STAGE 78: REAR LEFT WHEEL OUTER RIM

**STAGE 79: REAR LEFT WHEEL -
FITTING THE INNER SPOKES**

**STAGE 80: REAR LEFT WHEEL -
FITTING MORE SPOKES**

**STAGE 81: REAR LEFT WHEEL -
FITTING THE TYRE**

STAGE 82: THE BOOT COVER

Advice from the experts

Spare screws are included with each part. Occasionally, you may be instructed to keep spare or unused screws for a later stage. Keep these spares in a safe place and label them correctly.

Please make sure you don't mix up the screws. They look quite similar, but the threads do vary slightly. Using the wrong screws may damage the parts.

When securing parts together using multiple screws, fit each screw loosely to ensure all the parts are correctly aligned before gently tightening them firmly, but not overtight, in the order in which you placed them.

The screwdriver can be magnetized by stroking it with a magnet (fridge magnet, etc.) enabling it to hold the screws and make assembly easier.

If a screw is tight going into a metal part, do not force it as you may shear the head off. Remove it and put a tiny smear of Vaseline, soap or light oil on the thread. That will lubricate it and make it easier to drive home.

During the course of this build, you will receive many pieces that you will assemble immediately – following the instructions in the corresponding stage – and other pieces that you should store safely to one side, for use in future assembly stages.

Left and Right! When building your Jaguar, the left or right hand side refers to each side as you are sitting in the car.



WARNING: Some parts are assembled using magnets. These magnets can cause serious injury if they are swallowed. Keep away from children. If you suspect a magnet has been swallowed, seek medical help straight away.

Stage 74: Right-hand Headlight Cover and Valance

In this first stage of Pack 10 you'll fit the valance, which reinforces and improves airflow of the bonnet, as well as assembling and attaching the cover for the right headlight. The bonnet grille and catch are also fitted in this stage.



STAGE 74 PARTS LIST

Name
Right-hand valance
Right headlight surround
Right headlight glass cover
Bonnet grille and catch
Screws type AM09 x3
Screws type AM15 x4

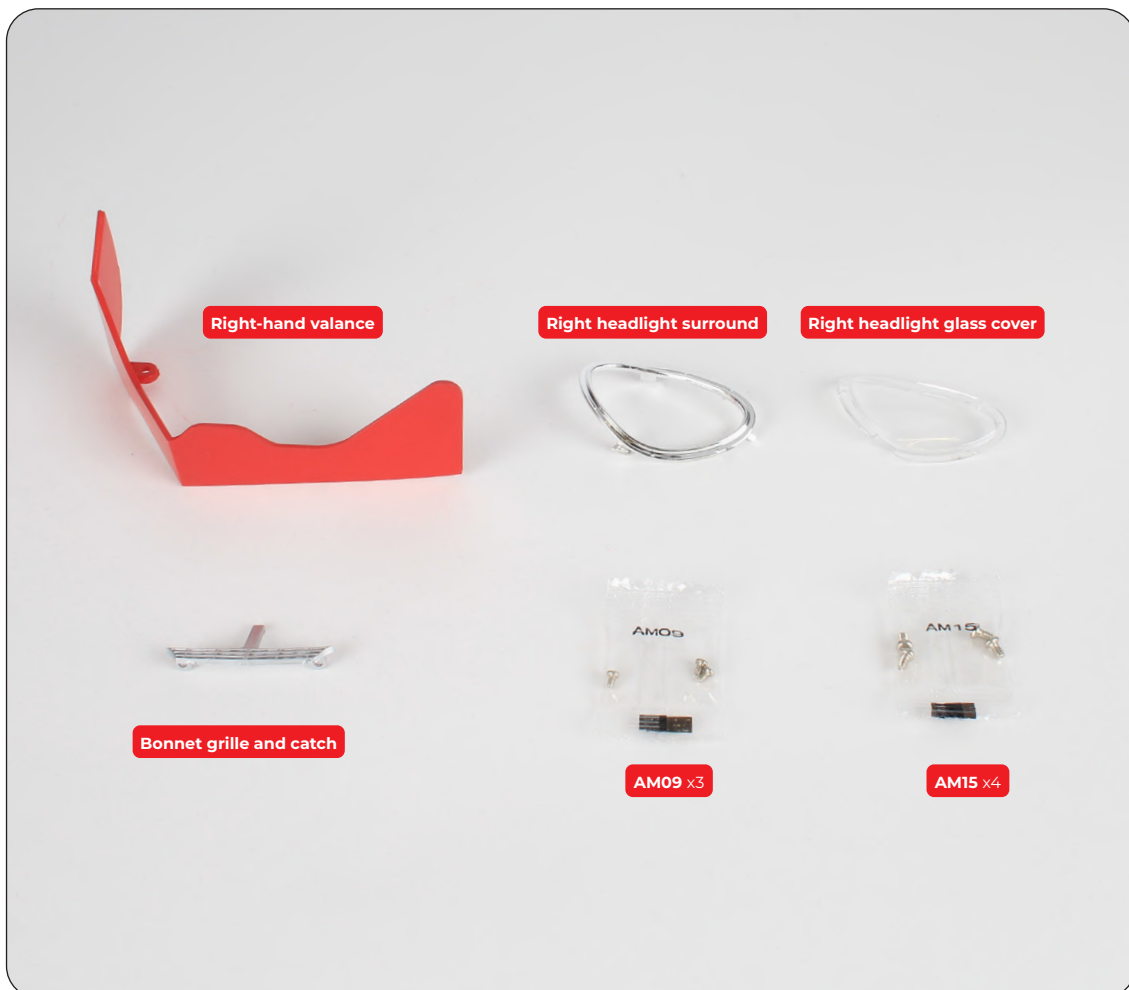

Stage 74: Right-hand Headlight Cover and Valance

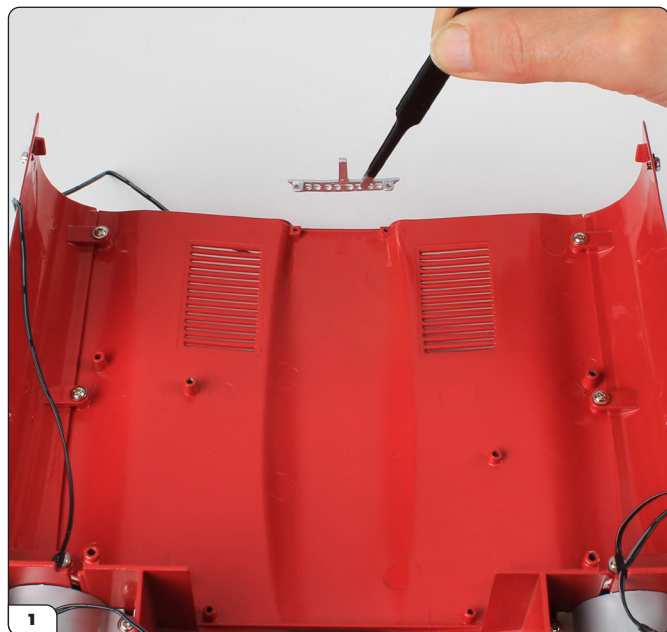

1 Take the bonnet assembly from Stage 73. Align the bonnet grille and catch with the two holes on the underside of the bonnet as shown.

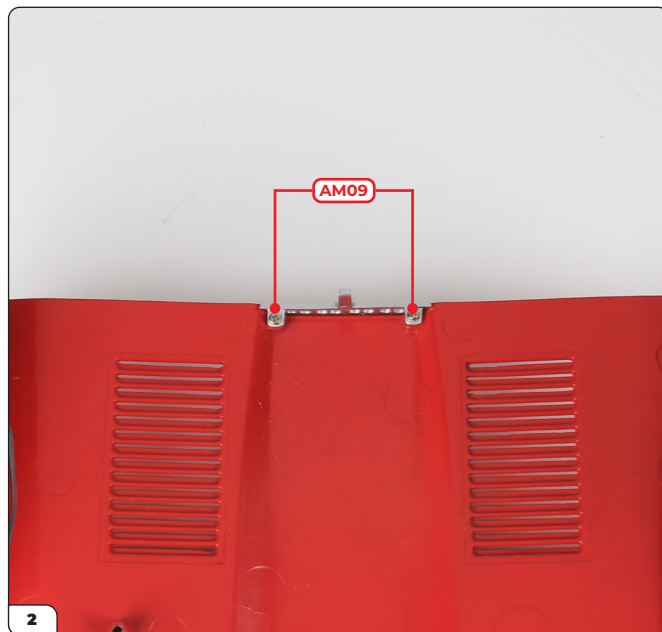

2 Fit the bonnet grille and catch into place, then secure in place with 2x AM09 screws.

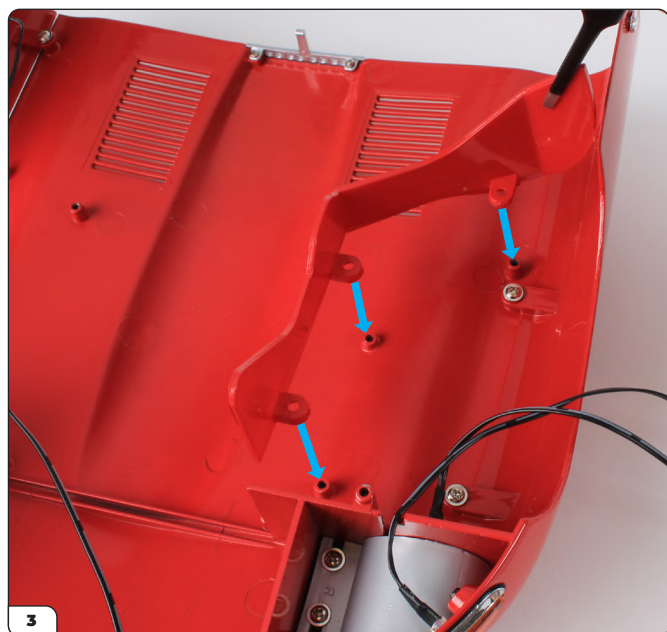

3 Next align the valance with the bonnet as shown. The three screw holes of the valance fit over the corresponding holes located on the bonnet (arrows).

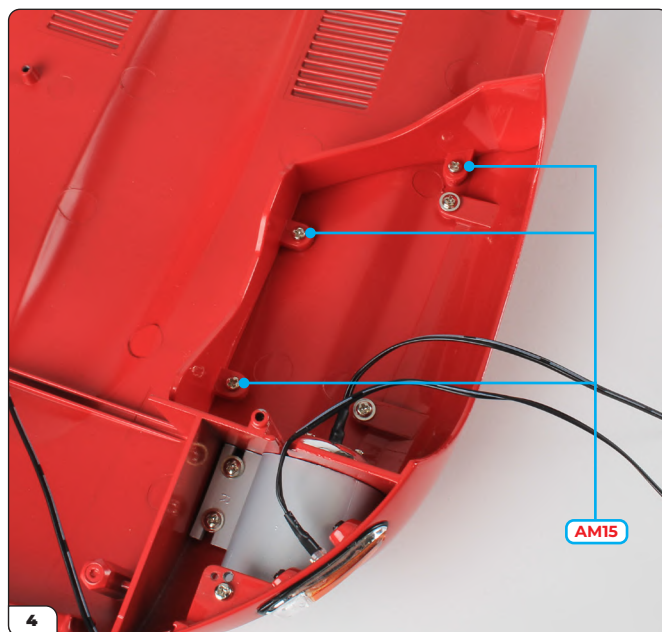

4 Fit the valance in place then secure to the bonnet using 3x AM15 screws.

Stage 74: Right-hand Headlight Cover and Valance



Now take the right headlight surround and glass cover. Note the three lugs (arrows) and tabs (circled) for fitting the parts together. We recommend test fitting the two parts before proceeding.

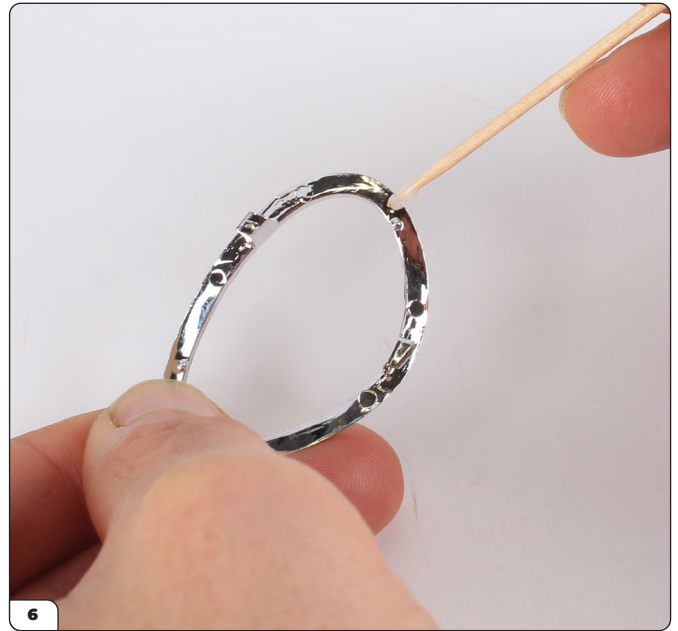

When happy with the fit, apply a small amount of PVA glue to the surround. This should stop the glass popping out after the headlight cover has been put in place.



Firmly press the two parts together so that the fit is flush and allow the glue time to dry.



Before pushing the headlight cover in place, we recommend cleaning the inside with a cloth to remove any traces of dust and fingerprints from the glass.

Stage 74: Right-hand Headlight Cover and Valance



Align the headlight cover with the right-hand headlight as shown. Take care to fit the notch (inset) into place first, then press the cover until it sits over the headlight.



The cover should look like this once it has been fitted onto the bonnet over the headlight.

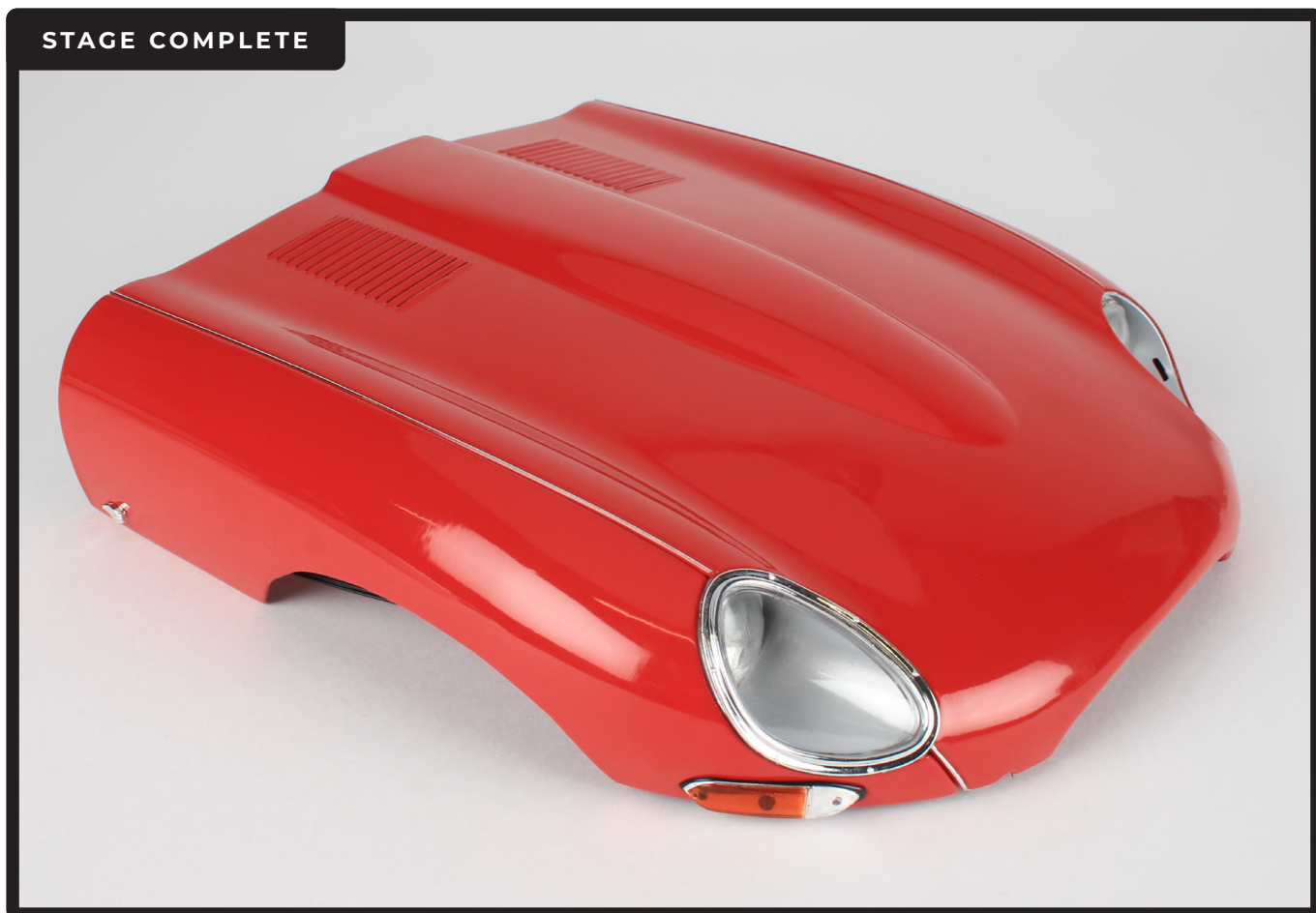

Stage 75: Left-hand Headlight Cover and Valance

The next stage is to fit the left-hand valance to the bonnet, which features the air intake for the heaters. You'll assemble and attach the left headlight cover as well.



STAGE 75 PARTS LIST

Name
Left-hand valance
Heater air intake
Left headlight surround
Left headlight glass cover
Screws type AM15 x4

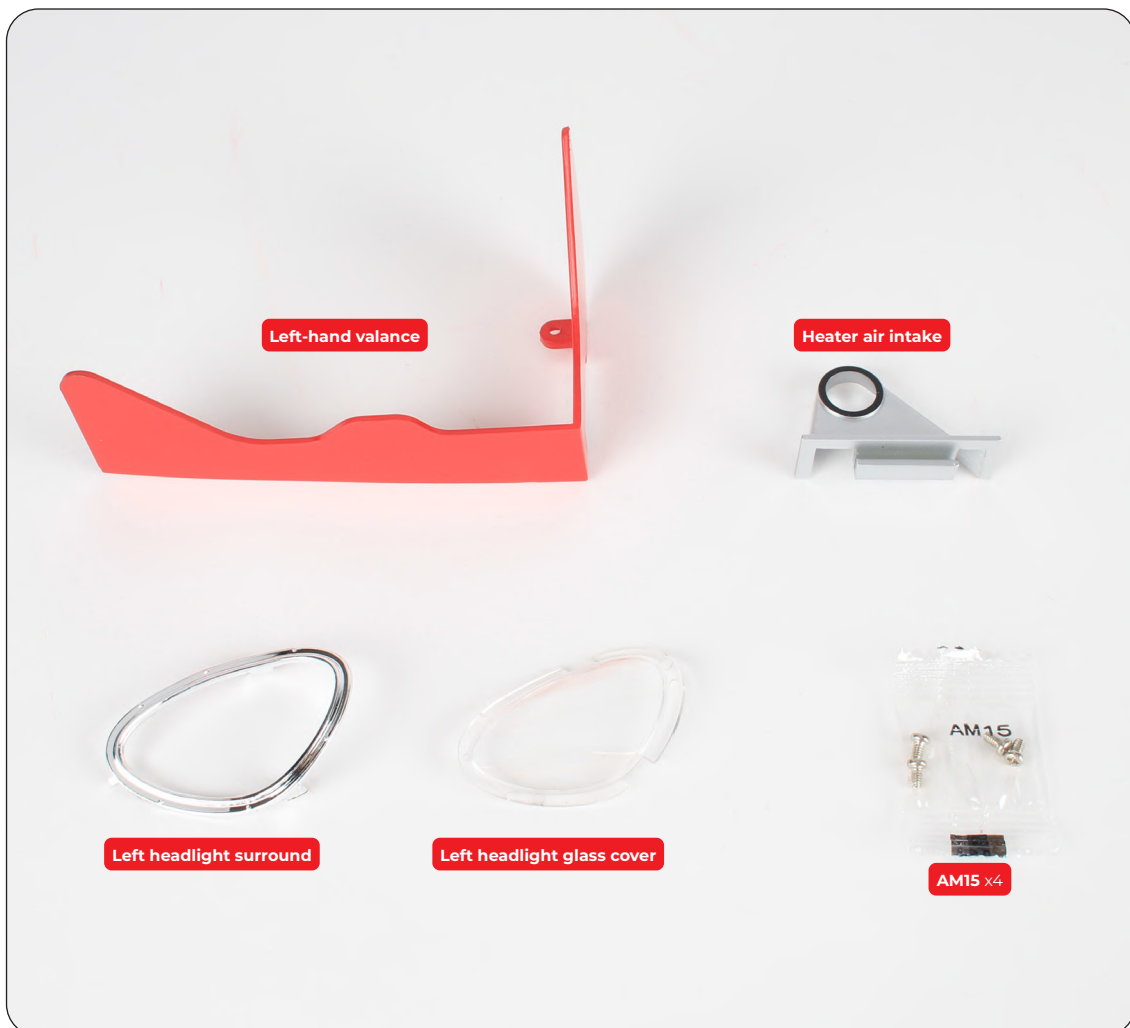

Stage 75: Left-hand Headlight Cover and Valance

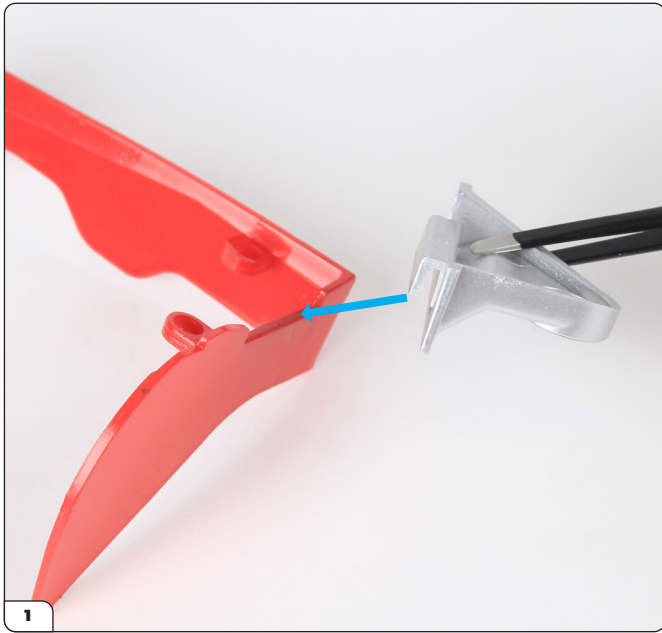

Take the heater air intake and align it with the left-hand valance as shown. Note the indent in the valance to accommodate the heater air intake (arrow).



Firmly press the heater air intake onto the valance.

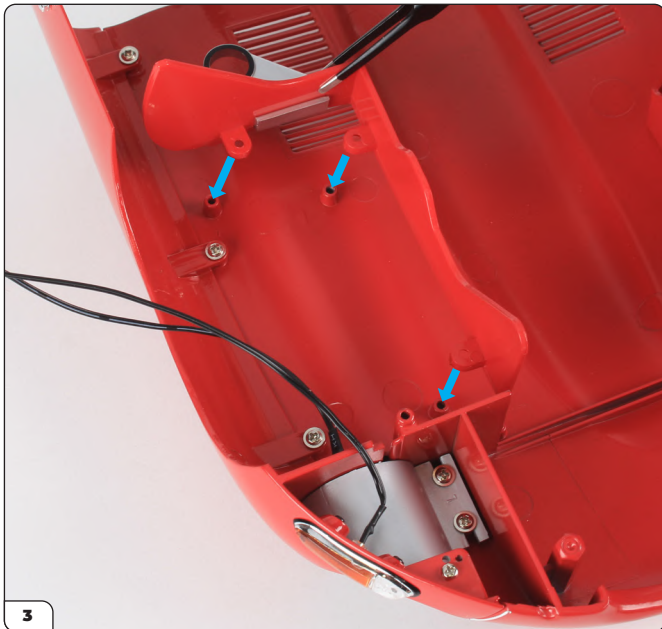

Next align the valance with the bonnet as shown. The three screw holes of the valance fit over the corresponding holes located on the bonnet (arrows).

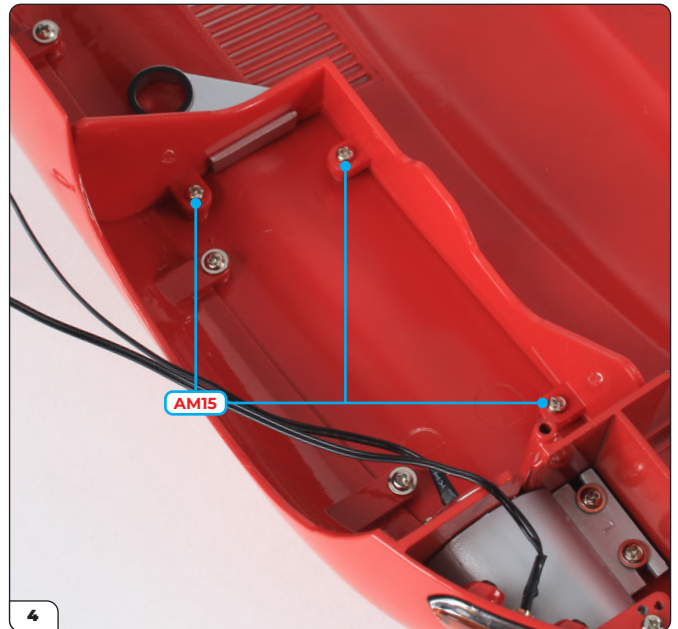

Fit the part in place then secure to the bonnet using 3x AM15 screws.

Stage 75: Left-hand Headlight Cover and Valance



Now take the left headlight surround and glass cover.



Apply a small amount of PVA glue to the surround.



Firmly press the two parts together so that the fit is flush and allow the glue time to dry. As you did with the previous headlight cover, clean the parts to remove any dust or fingerprints from the glass.



Fit the headlight cover in place, taking care to fit the notch (inset) into place first.

Stage 75: Left-hand Headlight Cover and Valance

STAGE COMPLETE



Stage 76: Attaching the Stone Guard

In this stage you'll assemble and attach the stone guard to the bonnet.



STAGE 76 PARTS LIST

Name
Stone guard frame
Stone guard mesh
Screws type AG01 x5
Screws type AM10 x3



Stage 76: Attaching the Stone Guard

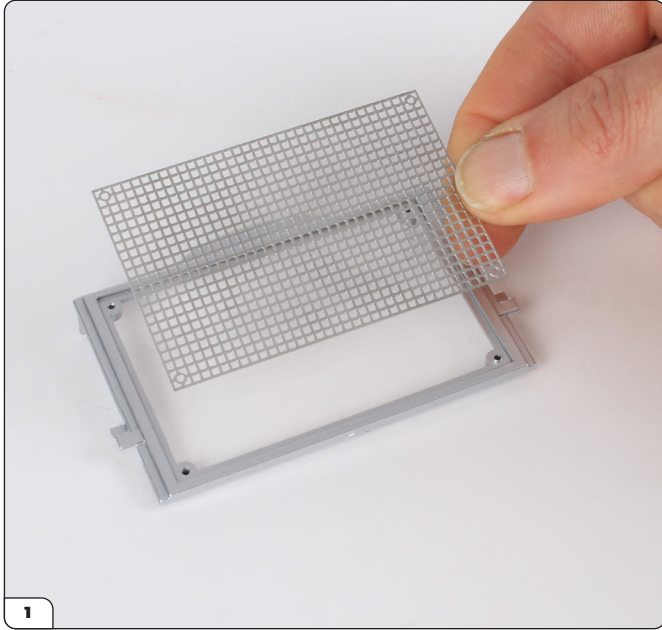

Place the stone guard mesh into the recessed area of the stone guard frame as shown.

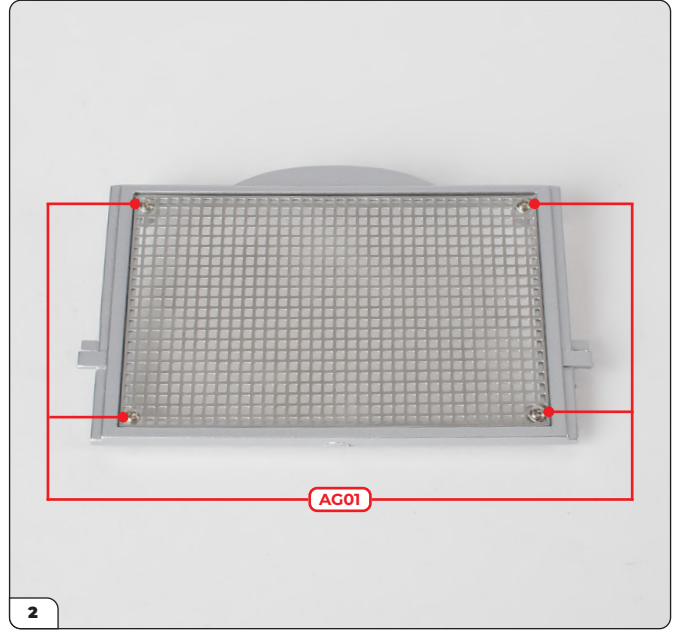

Secure the mesh in place using 4x AG01 screws.

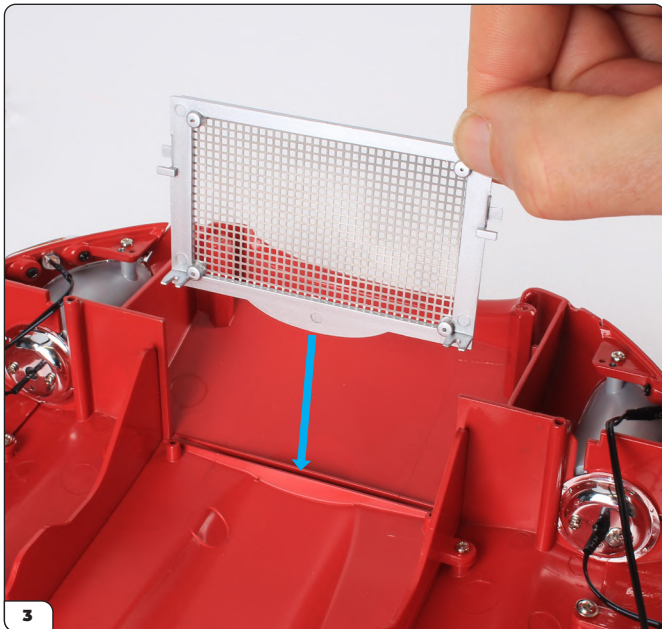

Take the stone guard and align it with the underside of the bonnet as shown. Fit into place, so that the curved section of the stoneguard sits in the slot on the bonnet (arrow). The protruding bars (circled in picture 4) should sit either side of the vertical edges.

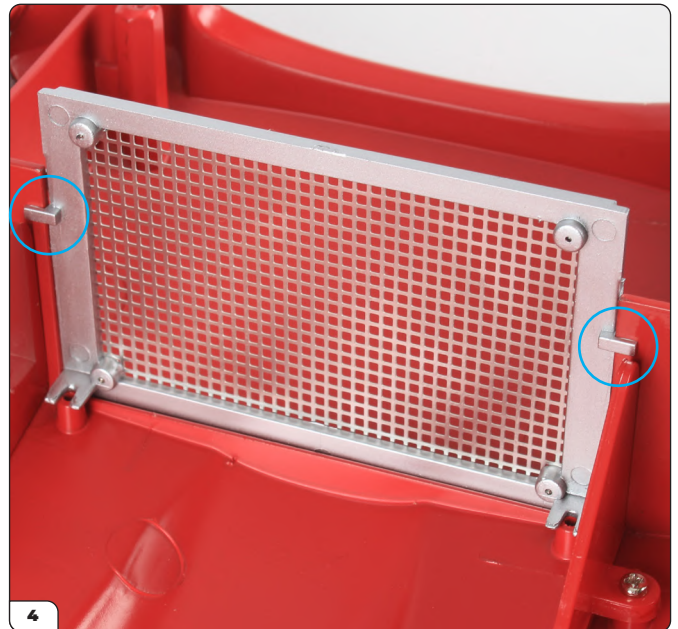

The stone guard should look like this once in place.

Stage 76: Attaching the Stone Guard

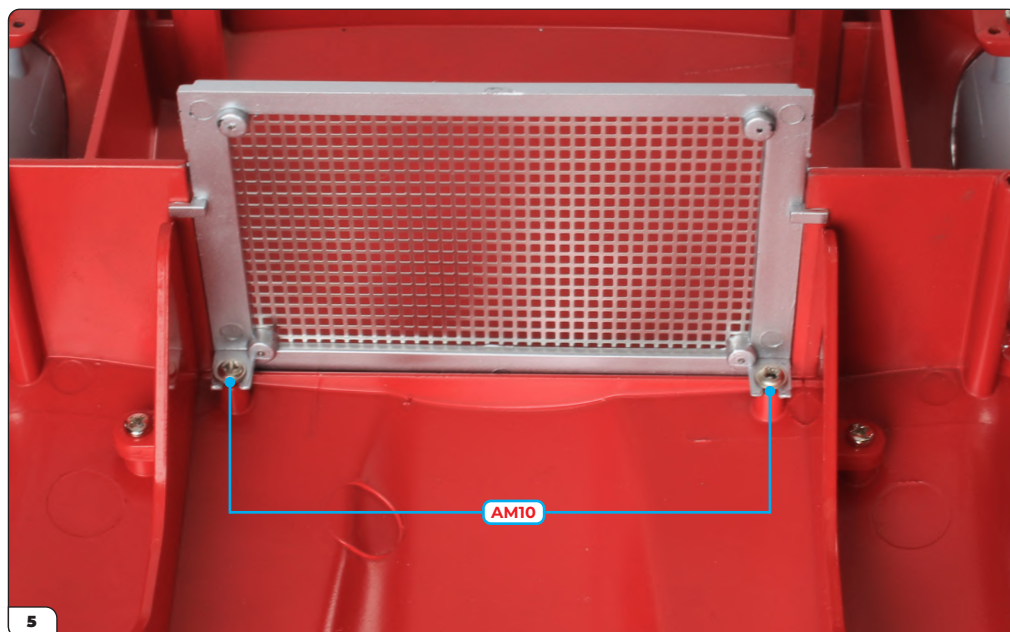

Fix the stone guard to the bonnet using 2x AM10 screws.



Stage 77: The Front Underpanel

Next the front underpanel is put in place to reinforce the bonnet further.



STAGE 77 PARTS LIST

Name
Front underpanel
Screws type AM11 x3
Screws type AM15 x3



Stage 77: The Front Underpanel

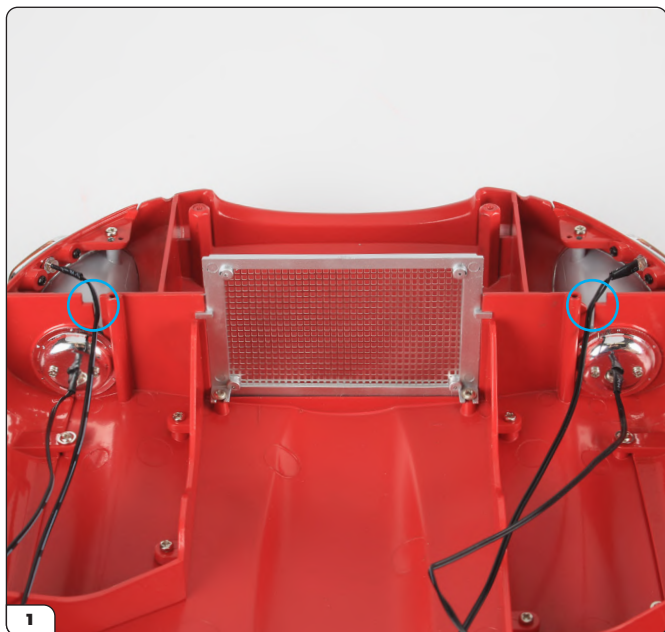

1
Before fitting the front underpanel, ensure that the wires from the sidelights are tucked into the openings for them provided by the bonnet (circled).

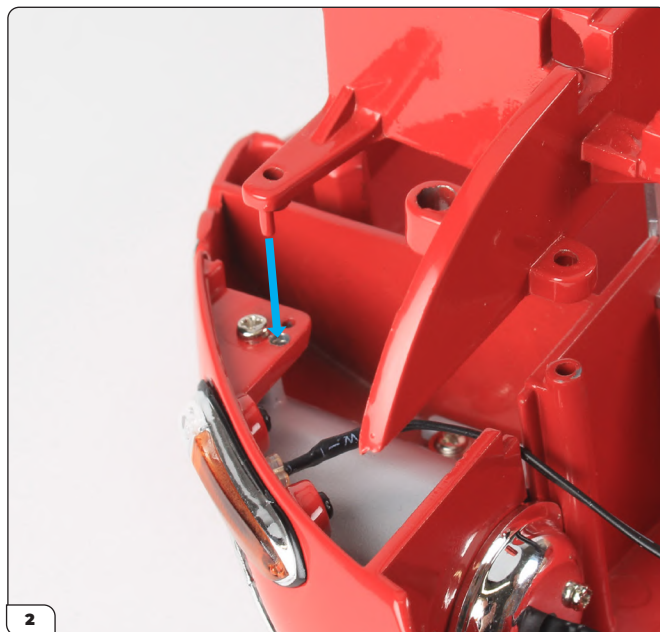

2
Take the front underpanel. Note that on each end, there is a small plug that corresponds to a small hole in the bonnet (arrow). Use these as a guide when aligning the underpanel.



3
Align the underpanel with the bonnet and fit into place. Don't worry if the small plugs at either end do not remain in place for now.

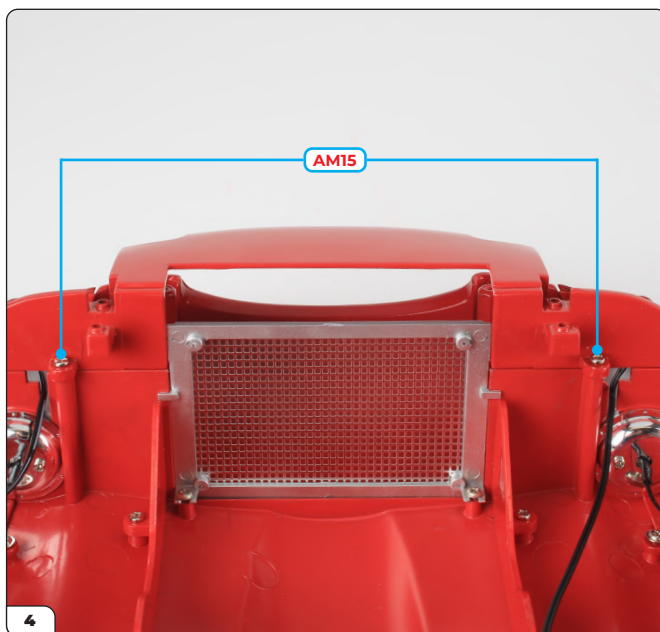

4
Take 2x AM15 screws and drive them into the screw holes as shown.

Stage 77: The Front Underpanel

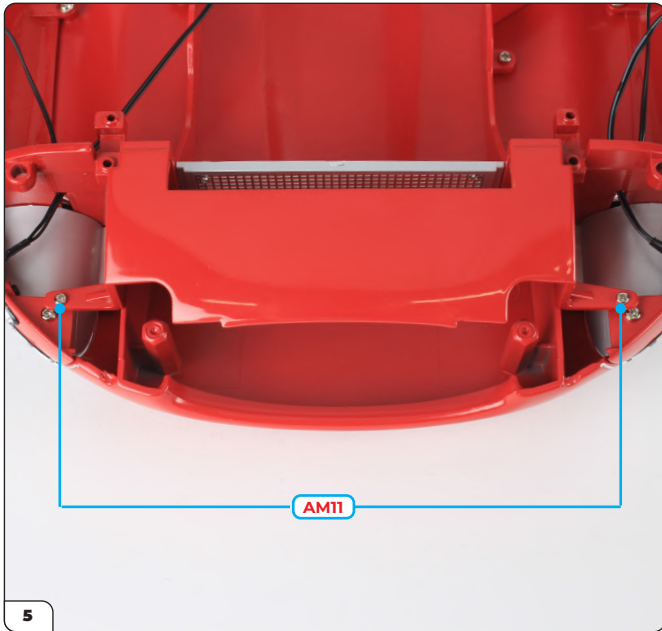

On the other side of the underpanel, drive 2x AM11 screws into the screw holes located next to the small plugs. As you do, make sure the plugs push inside their holes.



This image shows the plugs properly located in the holes after the AM11 screws have been driven in.



Stage 78: Rear Left Wheel Outer Rim

There is no assembly in this stage, unpack the wheel components and move straight to Stage 79.



STAGE 78 PARTS LIST

Name
Inner spokes x24
Wheel rim (outer)



Stage 79: Rear Left Wheel – Fitting the Inner Spokes

In this stage you'll begin assembling the rear left wheel. The process for this final wheel is exactly the same as for the previous wheels.



STAGE 79 PARTS LIST

Name
Spoke retainer ring
Wheel centre
Inner spokes x24
Screws type AG02 x5

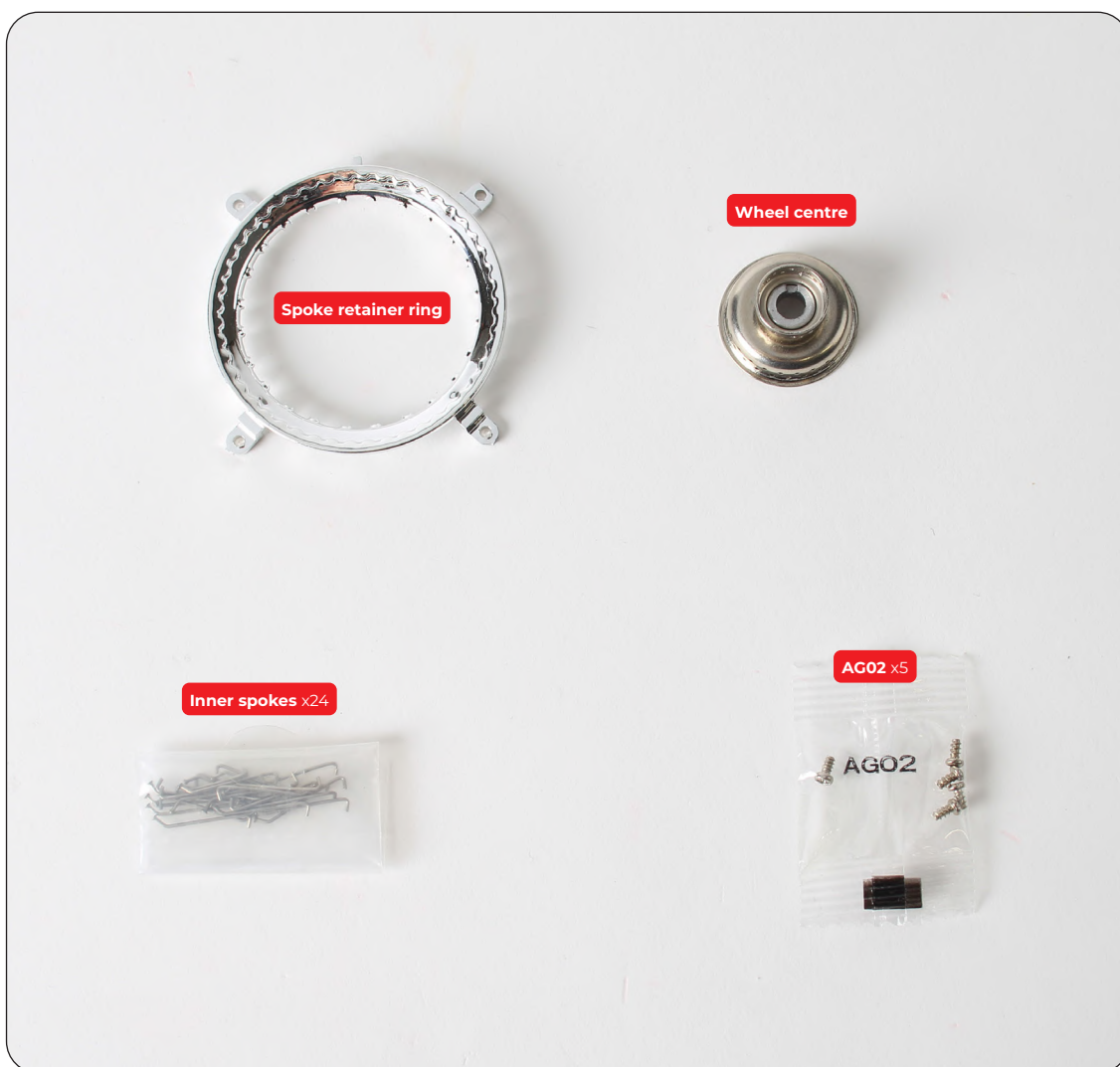

Stage 79: Rear Left Wheel – Fitting the Inner Spokes

STEP 1

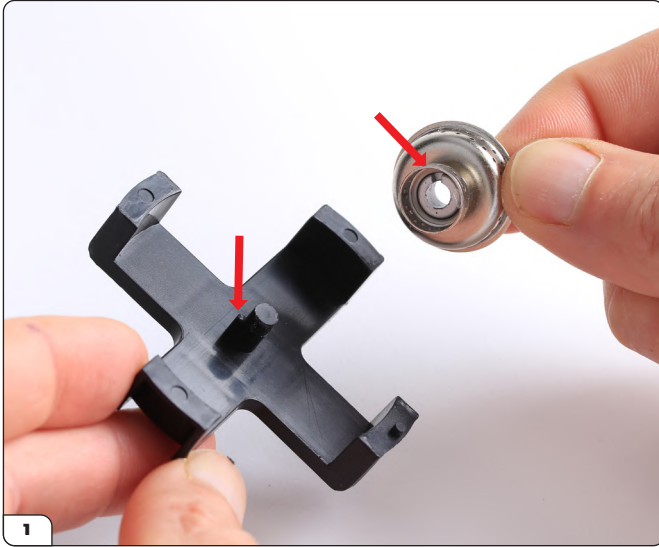

Take the wheel centre and note that there is a small notch that aligns with a corresponding tab on the jig (arrows). The jig is used here to assist with building the wheel and will be removed towards the end of the wheel-build.



Fit the wheel centre onto the jig.

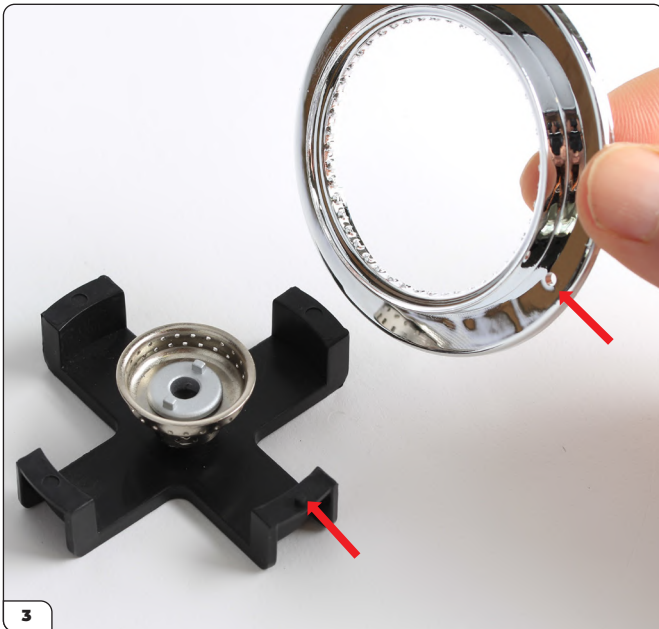

Take the wheel rim from Stage 78 and align the hole on the outer edge with the pin on the jig (arrows).



Fit the wheel rim onto the jig, pressing firmly to lock the rim into position.

Stage 79: Rear Left Wheel – Fitting the Inner Spokes

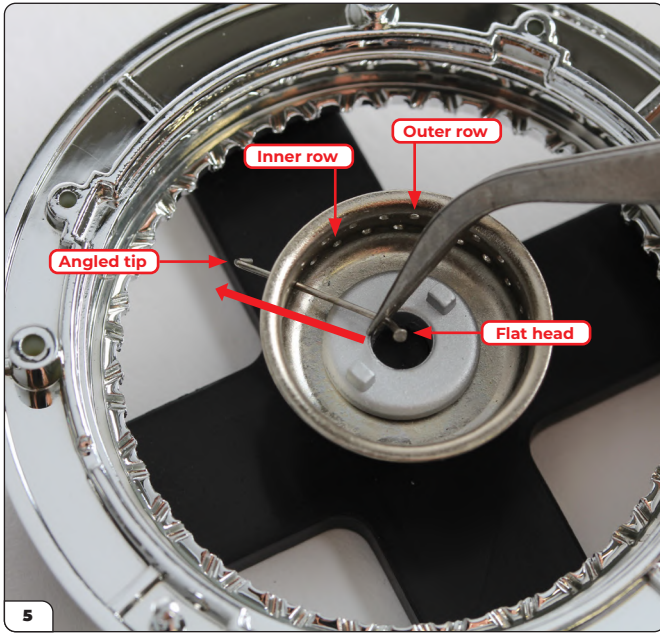

Before you begin, note that the inner edge of the spoke retainer ring has a series of 'teeth', alternating in size (see picture 6). Each spoke has a right-angled tip, and a flat head on the opposite end. Use your tweezers to thread the spokes and hook them into place. Start by threading a spoke, leading with the tip, through a hole in the innermost row of holes in the wheel centre. (Note: The spokes in Stages 78 & 79 are the same.)

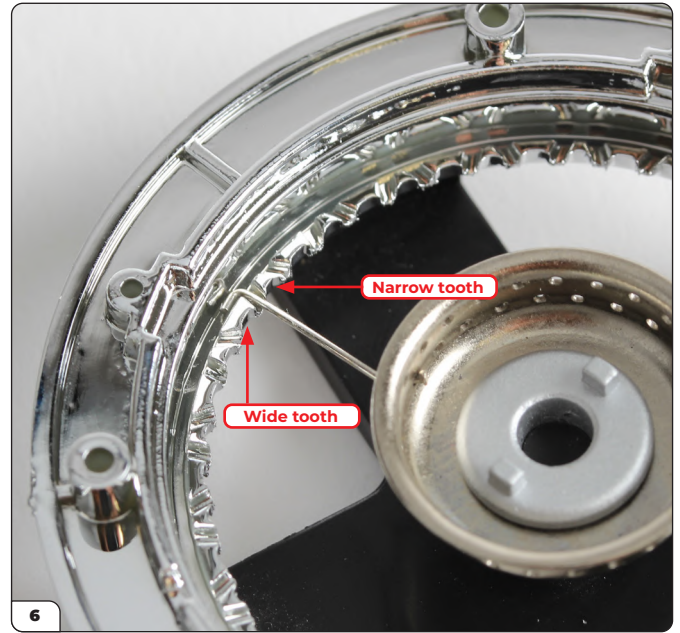

Pull the spoke through the hole and hook the tip around the nearest 'wide' tooth that gives the spoke a comfortable fit.

NOTE: The key to fitting the spokes correctly is to adjust the tension on each spoke as you fit it by gently pushing and/or twisting the wheel centre with your thumb.



Then take another spoke and thread it through the next hole in the innermost row of the wheel centre. Pull the spoke through the hole and hook the tip around the next 'wide' tooth.



Fit the third spoke in the same way, and continue all the way around the wheel until you have filled all the holes on the inner row of the wheel centre. Check that they are hooked around the **wide teeth**. If they are not hooked around wide teeth, the spokes will not fit and the wheel parts will not fit together at the end of the build.

Stage 79: Rear Left Wheel – Fitting the Inner Spokes



This is how your wheel should look after fitting the first row of spokes.



Check that all the spokes have been fitted to the innermost row of the wheel centre. Next, you will fit spokes to the uppermost row.



Start in the same way, threading the tip of a spoke through a hole in the uppermost row.



The spoke tips will now face in the opposite direction to those fitted on the bottom row. Make sure that they are hooked around a 'wide' tooth otherwise they cannot be secured in place in a later step.

Stage 79: Rear Left Wheel – Fitting the Inner Spokes



Repeat steps 11 & 12 to fit the second spoke in a hole adjacent to the first spoke on the upper row.



Continue to fit all the spokes in the same way, all the way round the upper row, ensuring that they hook around a wide tooth.

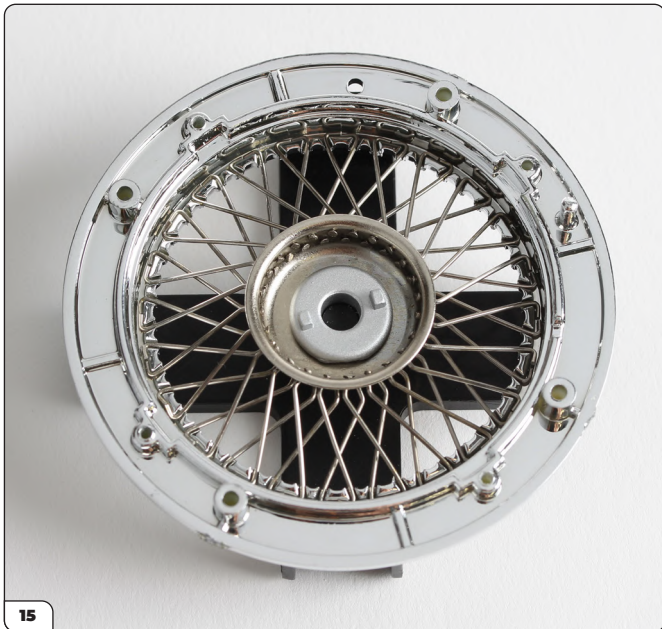

The second row of spokes has been fitted.

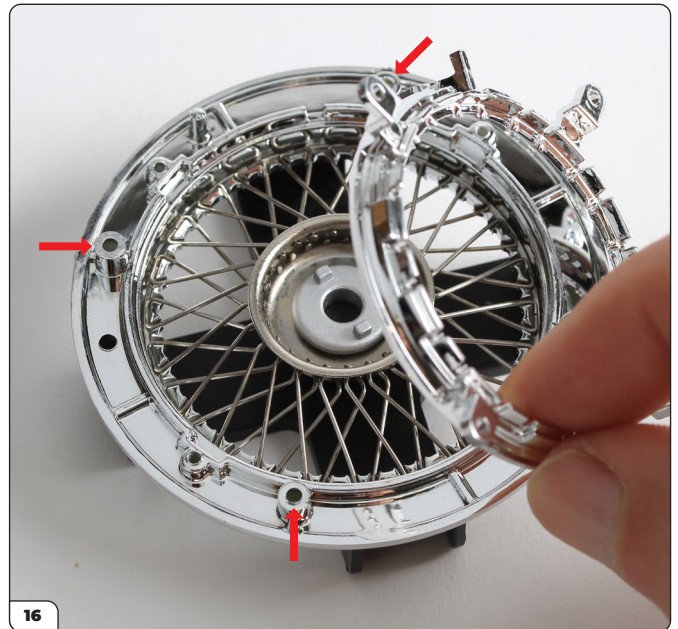

Prepare 4 x AG02 screws and have your screwdriver ready. Carefully align the spoke retainer ring over the wheel. The projecting screw holes on the ring will fit onto the raised screw holes as indicated. Lower the ring into position.

Note: the projecting pin on the spoke retainer locates in the notch in the wheel rim.

Stage 79: Rear Left Wheel – Fitting the Inner Spokes



Hold the retainer in position so that the spokes are secured as you fit an AG02 screw.



Keep holding everything together as you fit the remaining 3 x AG02 screws.

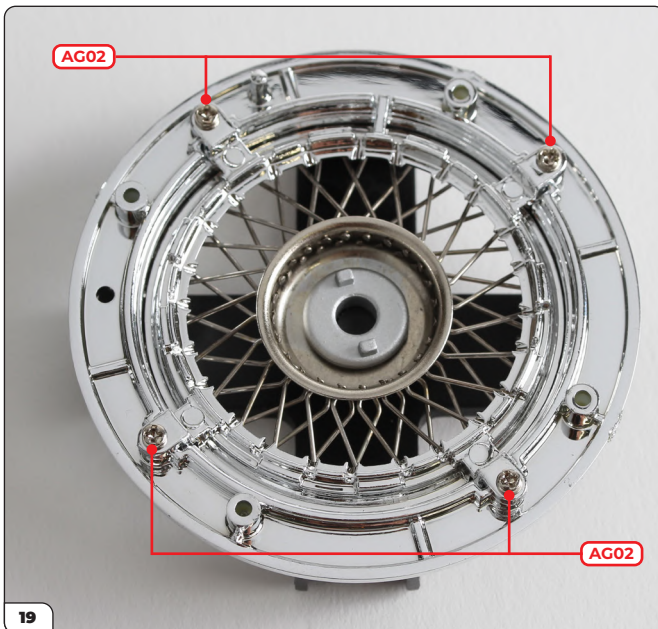

All four screws have been fitted and the spokes are now held securely in place.

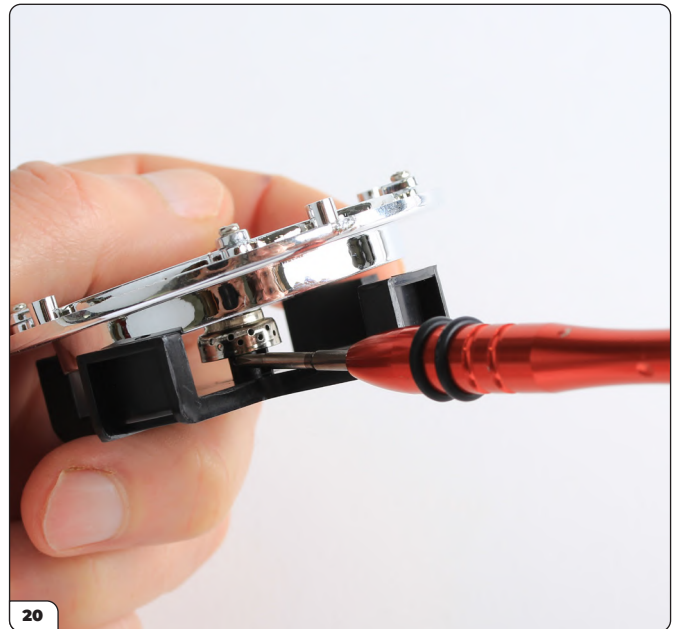

Gently prise the wheel off the jig. Do not pull the wheel – try to carefully release it using a screwdriver or similar tool that will act as a lever.

Stage 79: Rear Left Wheel - Fitting the Inner Spokes

STAGE COMPLETE



Stage 80: Rear Left Wheel – Fitting More Spokes

In this next stage you'll continue to lace more spokes. The tyre will be supplied in the next stage.



STAGE 80 PARTS LIST

Name
Spacer ring
Wheel rim (inner)
Spokes type A x12
Spokes type B x12
Screws type AG03 x5



Stage 80: Rear Left Wheel – Fitting More Spokes

STEP 1

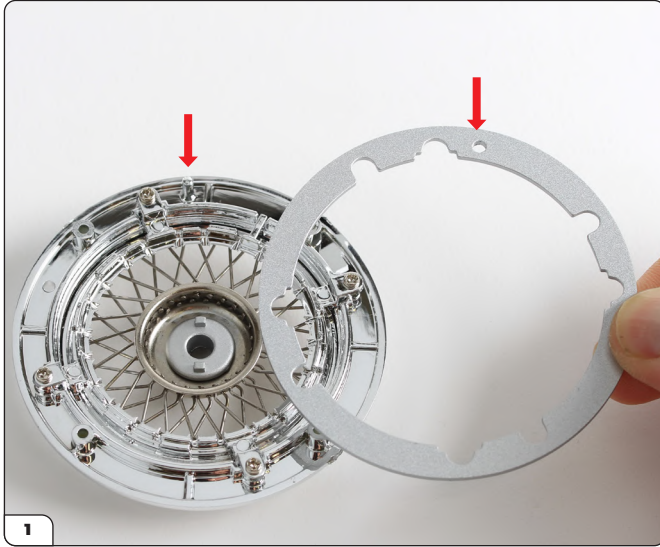

Take the spacer ring and align it over the wheel from Stage 79. There is a hole on the ring with a corresponding peg on the wheel (arrows) to ensure the correct fit.

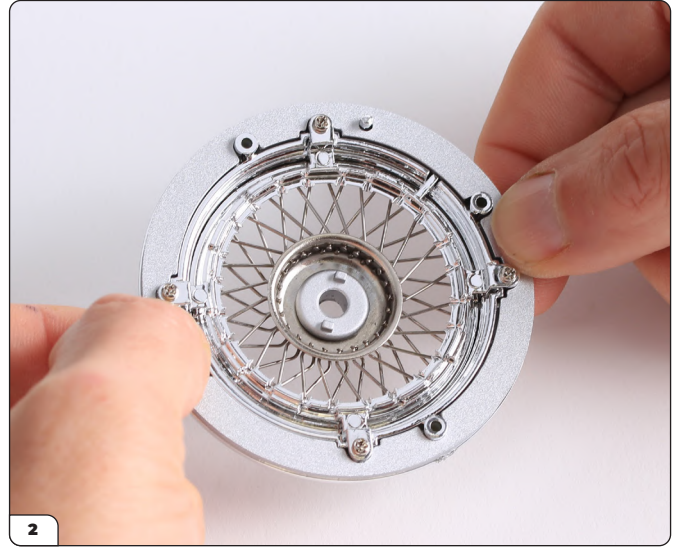

Lower the ring onto the wheel and press firmly until it clicks into place.

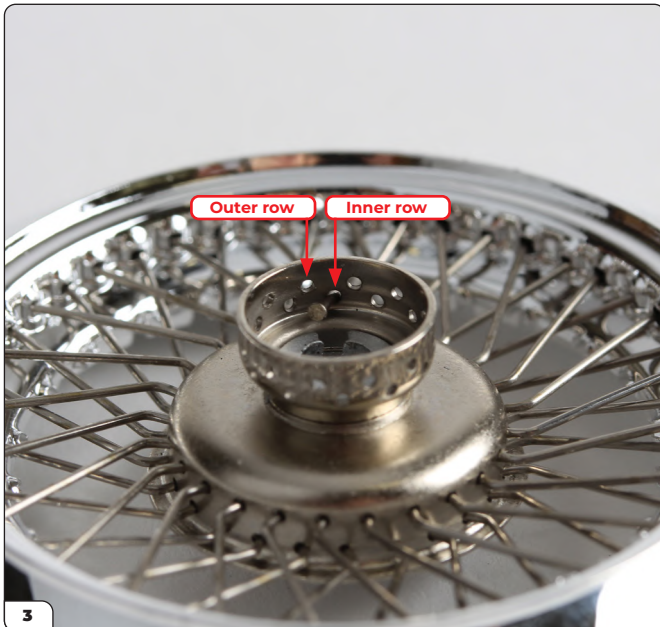

Turn the wheel over so that the smaller side of the wheel centre is facing you. Note that there are two rows for threading the spokes – an inner row and an outer row. You're going to start on the inner row.

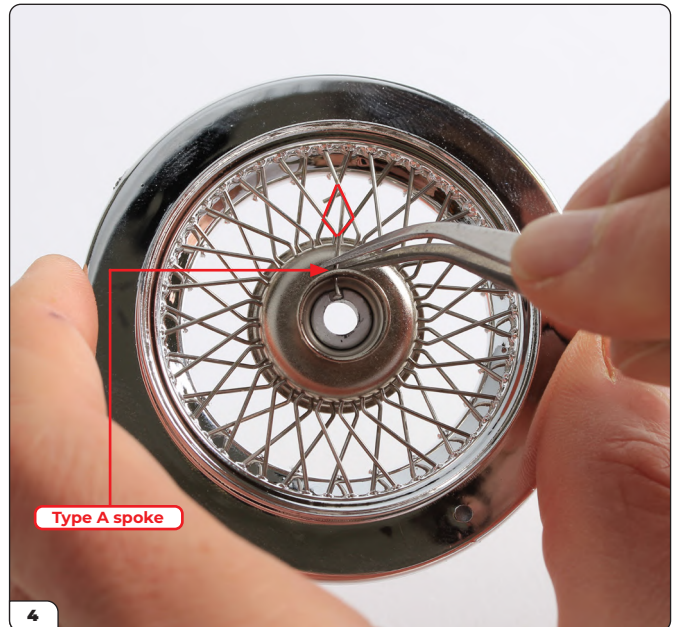

Using tweezers, thread a type A spoke through a hole on the **inner row**. Direct the tip of the spoke through the diamond-shaped opening slightly clockwise (coloured red above) so that the tip pokes through to the opposite side.

Stage 80: Rear Left Wheel – Fitting More Spokes



Turn the wheel over and check that the tip will hook onto a wide tooth on the opposite side. If it doesn't fit a wide tooth, start again, threading the spoke through the next diamond-shaped hole along.



Once you are happy that the first spoke is fitted correctly, thread the next spoke through an adjacent hole in the lower row, but this time, poke it through the diamond-shaped hole that is two-along.



Continue to thread the type A spokes all the way around the inner row, pushing the tip through alternate diamond-shaped openings as indicated.



All 12 x type A spokes have been fitted to the inner row.

Stage 80: Rear Left Wheel – Fitting More Spokes

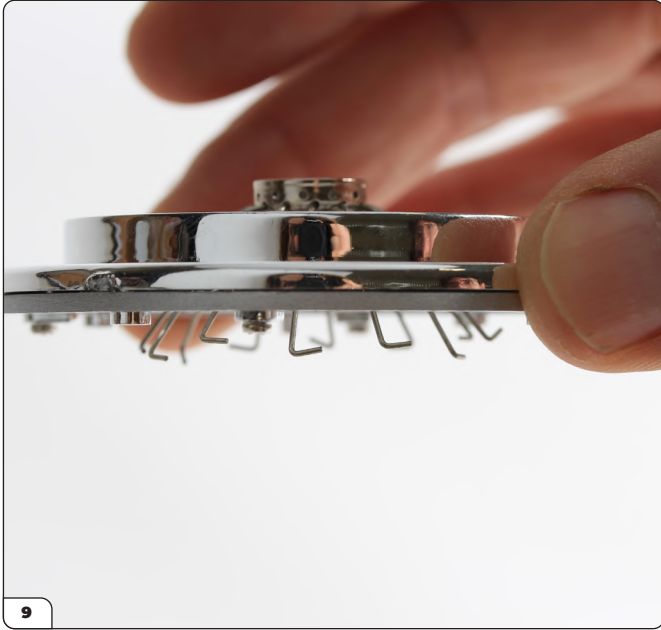

The 12 spokes should poke out on the opposite side of the wheel like this. Leave them all loose for now.



Fit the type B spokes to the outer row of the wheel centre, just above the type A spokes.



When you fit the first type B spoke, thread it through an empty diamond-shaped opening (see step 12) and check that it will hook around a wide tooth on the opposite side as shown here.

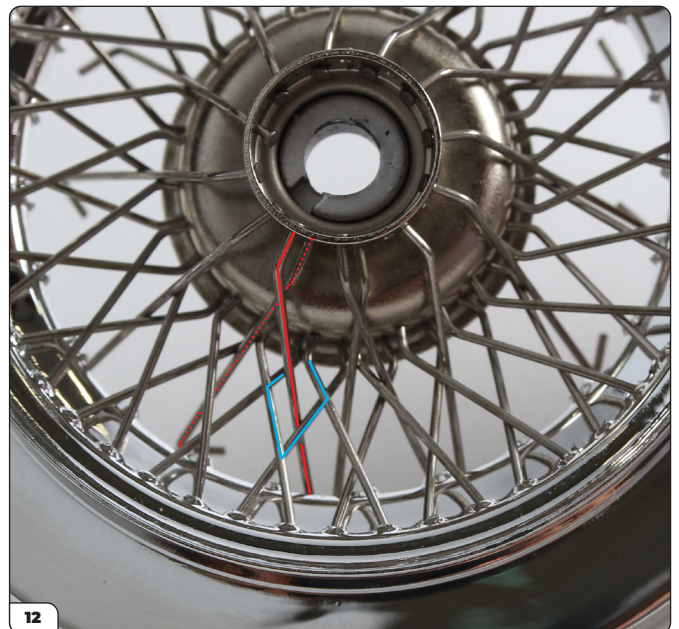

When you thread the type B spoke through to the opposite side, it should cross a type A spoke and fit through an empty diamond-shaped opening. It should lead slightly anti-clockwise. Check that it will hook a wide tooth, but do not hook it just yet, leave the spokes loose.

Stage 80: Rear Left Wheel – Fitting More Spokes



13
Continue to thread the type B spokes all the way around the outer row, pushing the spoke through alternate diamond-shaped openings. This picture shows all 12 x type B spokes have been fitted to the outer row of the wheel centre and are left loose on the underside.



14
Use a piece of cotton wool or kitchen paper to hold the pin ends of the spokes in place in the inner and outer rows of the wheel centre.

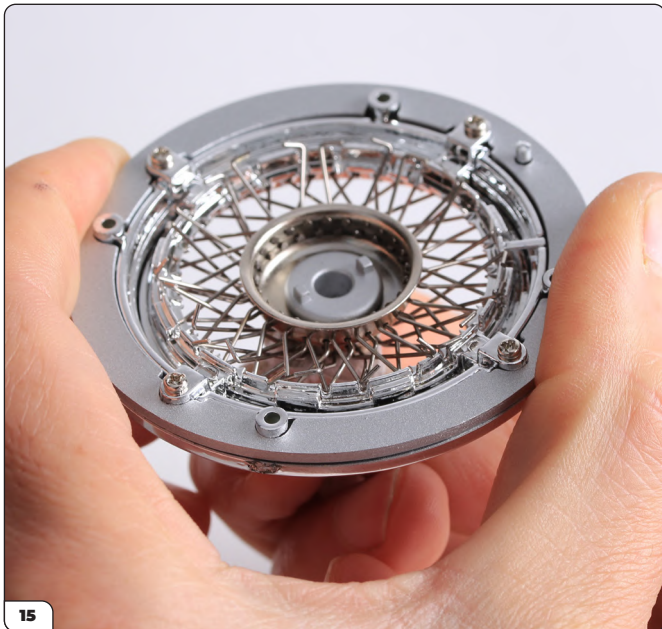

15
Keep holding the cotton wool firmly as you turn the wheel over.



16
Keep holding the wheel centre firmly, as you gently hook the ends of spokes A and B around the teeth. Use your thumb in a stroking motion, or tweezers here. The fit of the spokes can be lightly adjusted by gently pressing and/or twisting the wheel centre with your thumb.

Stage 80: Rear Left Wheel – Fitting More Spokes

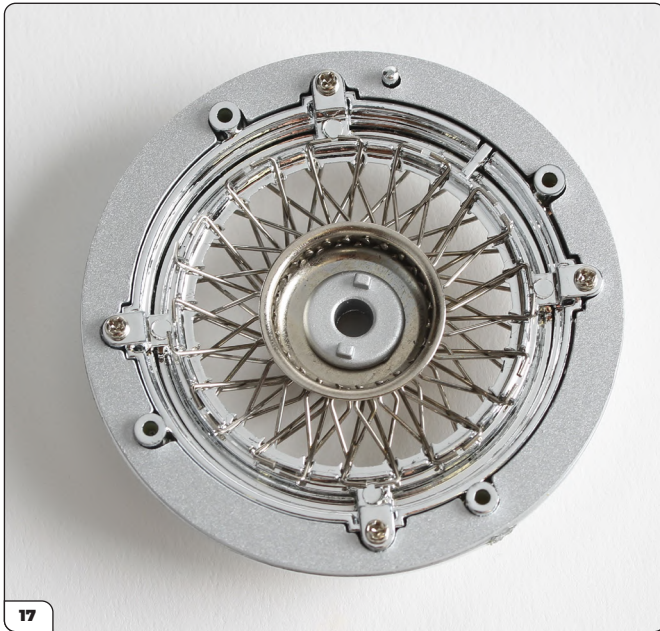

Spokes A and B are correctly hooked in place around the teeth.

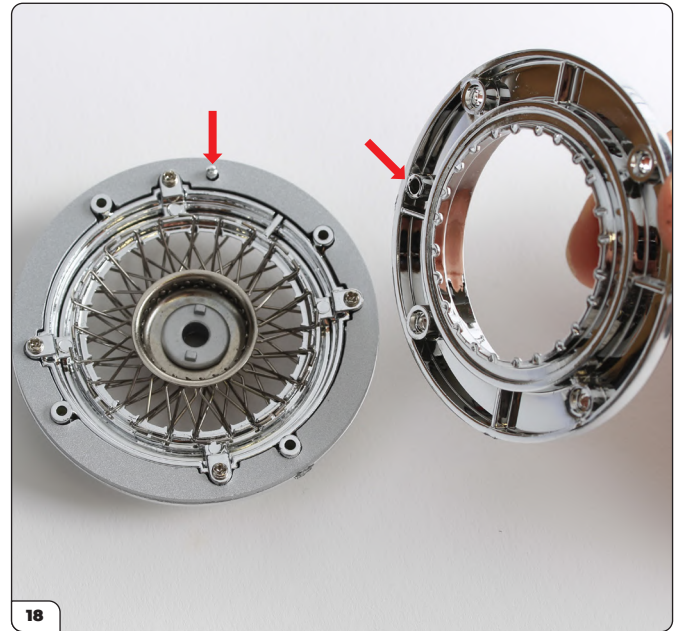

Take the inner wheel rim and align the four screw holes, and the pin with its corresponding hole (arrows). Prepare 4 x AG03 screws and a screwdriver.



Press the inner wheel rim into place. Check that the gap between the spoke retainer ring and the inner rim has closed up. If not, remove the inner rim and recheck the position of the spokes, Step 17.

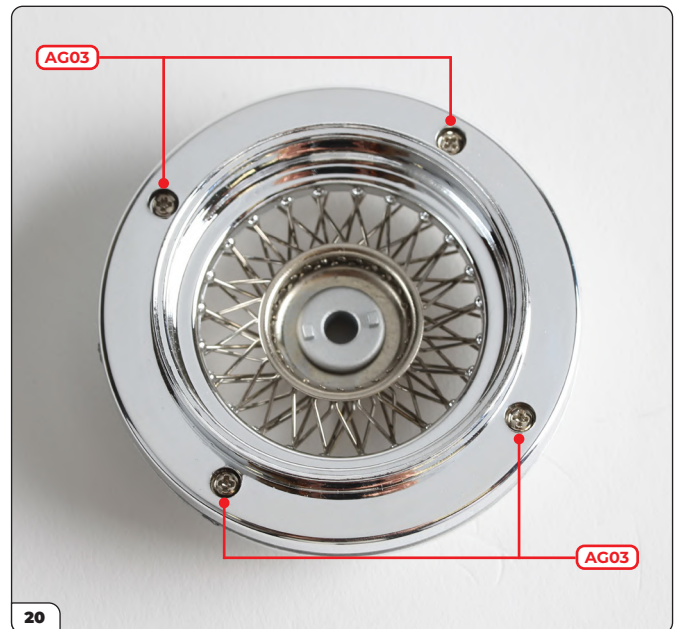

Fix the inner wheel rim in place with 4 x AG03 screws.

Stage 80: Rear Left Wheel – Fitting More Spokes



Stage 81: Rear Left Wheel – Fitting the Tyre

Now you'll fit the tyre onto the rear left wheel and attach it to the subframe assembly. After this stage, your Jaguar will have all its wheels in place!



STAGE 81 PARTS LIST

Name
Tyre
Washer
Screws type AM07 x2



Stage 81: Rear Left Wheel – Fitting the Tyre

STEP 1



Take the completed wheel from Stage 80. Prepare a hot water bath by filling a small bowl with boiling water. Soak the tyre in the water for 2 minutes.

Note: The tyre shown in pictures 1-4 is the spare tyre from Stage 25, and differs slightly in the tread pattern from the tyre supplied in this Stage. The method for fitting the tyre is the same.



Carefully remove the tyre from the water bath using tongs or tweezers - the tyre will be very hot! Shake off any excess water and dab on kitchen paper or a towel.



Working quickly while the tyre is pliable, push the wheel into the tyre and twist to fit the outer wheel rim under the inner rim of the tyre.

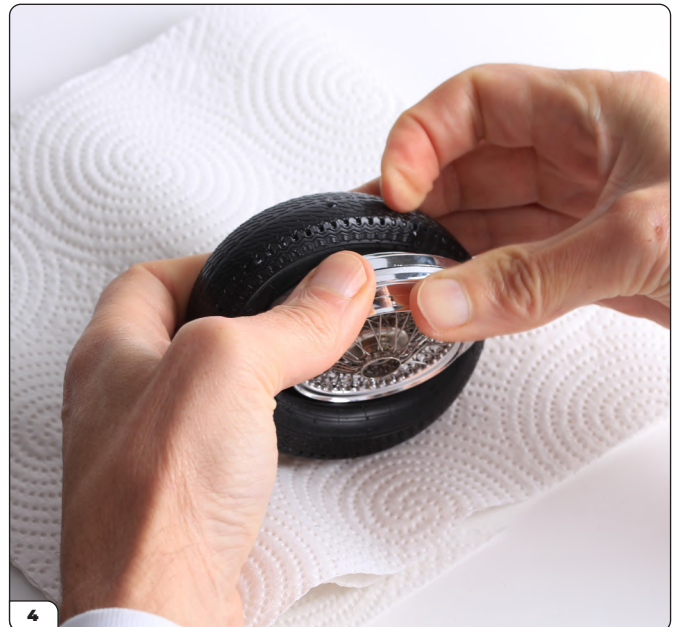

Keep pushing and pulling, working around the tyre, until the side walls fit comfortably over the wheel rim on both sides.

Stage 81: Rear Left Wheel – Fitting the Tyre



The tyre has now been fully fitted to the wheel and is now ready to fix to the front subframe assembly from Stage 48.



Prepare the front subframe assembly and rear left wheel.

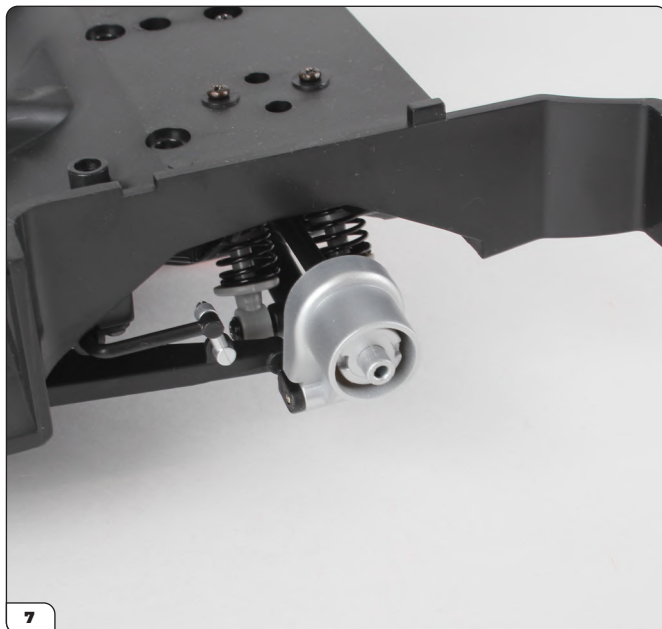

Lift the left-hand hub carrier and insert the universal joint fully into the hub carrier.



Holding the wheel as shown, align the two lugs on the wheel centre with the two notches in the left hub carrier (arrows). Position the wheel in place, ensuring the lugs fit into the notches.

Stage 81: Rear Left Wheel – Fitting the Tyre

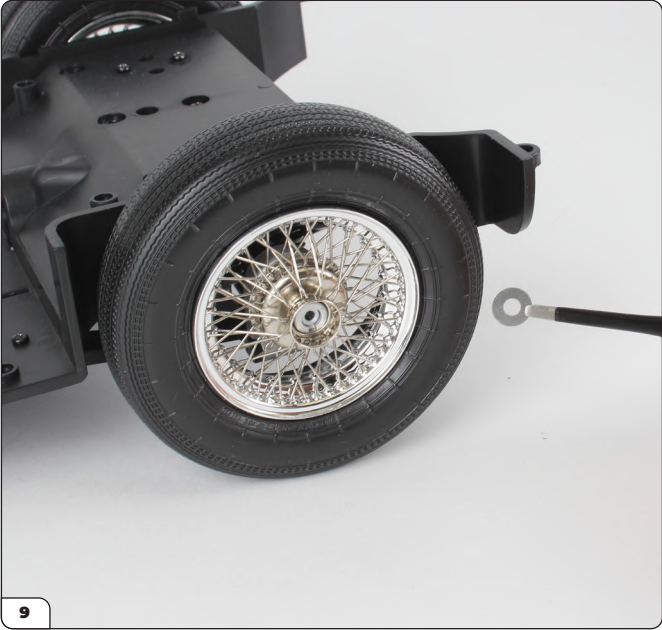

Take the washer and place it into the wheel centre.

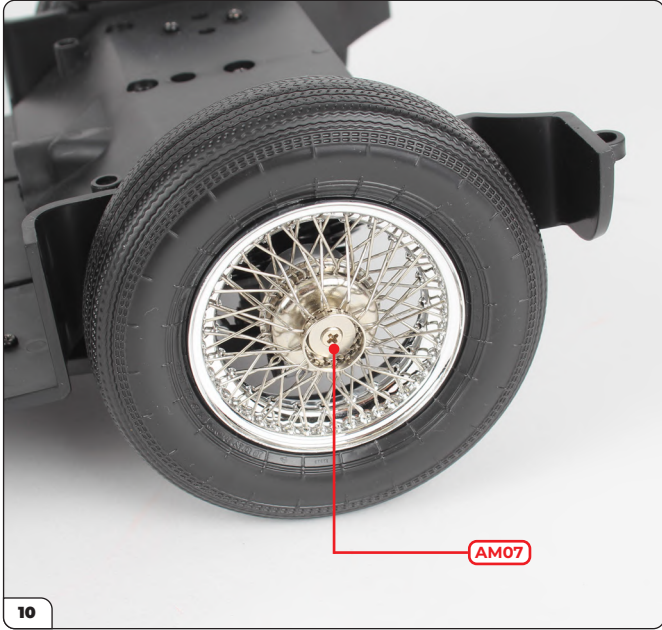

Secure the washer and wheel in place using a type AM07 screw.

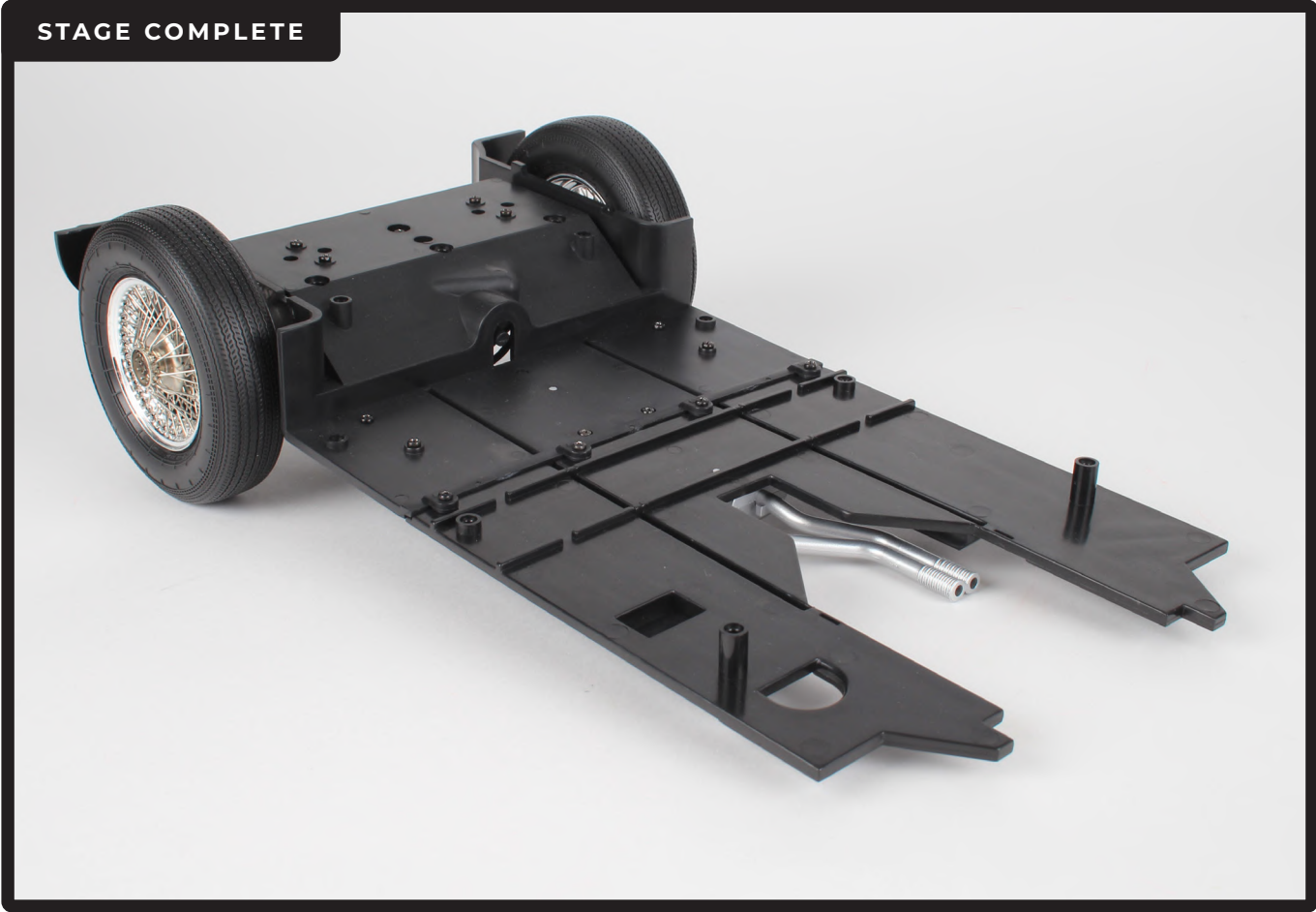

Stage 82: The Boot Cover

In this final stage for Pack 10, you'll assemble the boot cover by attaching the hinges and catch.

The mounting plates will be used in a later stage and can be stored away safely for now.



STAGE 82 PARTS LIST

Name
Boot lid
Boot hinges (left and right)
Mounting plate (left)
Mounting plate (right)
Boot lid catch
Screws type AM09 x3
Screws type AM18 x5



Stage 82: The Boot Cover



Differentiate the left boot hinge from the right using the 'L' and 'R' (circled) printed on the parts.



Take the left boot hinge and position it on the underside of the boot lid as shown (arrow) so that the two sets of screw holes align.



Secure the hinge in place using 2x AM18 screws.

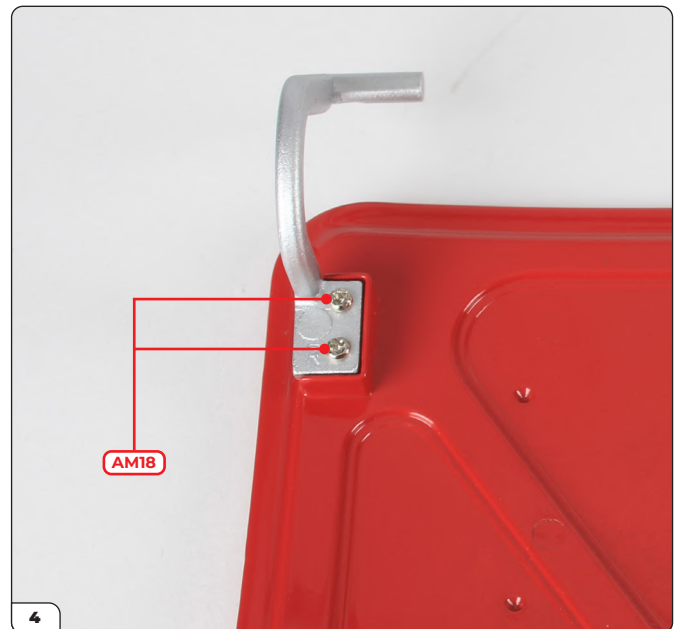

Repeat for the right boot hinge and fix in place with 2x AM18 screws.

Stage 82: The Boot Cover



Now take the boot lid catch and align it with the four holes on the underside of the lid as shown. Press into place so that the two lugs on the catch fit into the corresponding holes (arrows).



Secure the catch to the lid using 2x AM09 screws.

