



E-TYPE



Pack 05

BUILD INSTRUCTIONS

STAGE 32: STEERING SYSTEM COMPONENTS

STAGE 33: COOLING SYSTEM COMPONENTS

STAGE 34: THE FRONT BULKHEAD

STAGE 35: BULKHEAD FITTINGS
AND PIPEWORK

STAGE 36: BULKHEAD FITTINGS

STAGE 37: ENGINE BAY FITTINGS

STAGE 38: RIGHT FRONT WHEEL

STAGE 39: RIGHT FRONT WHEEL

STAGE 40: RIGHT FRONT WHEEL

Advice from the experts

Spare screws are included with each part. Occasionally, you may be instructed to keep spare or unused screws for a later stage. Keep these spares in a safe place and label them correctly.

Please make sure you don't mix up the screws. They look quite similar, but the threads do vary slightly. Using the wrong screws may damage the parts.

When securing parts together using multiple screws, fit each screw loosely to ensure all the parts are correctly aligned before gently tightening them firmly, but not overtight, in the order in which you placed them.

The screwdriver can be magnetized by stroking it with a magnet (fridge magnet, etc.) enabling it to hold the screws and make assembly easier.

If a screw is tight going into a metal part, do not force it as you may shear the head off. Remove it and put a tiny smear of Vaseline, soap or light oil on the thread. That will lubricate it and make it easier to drive home.

During the course of this build, you will receive many pieces that you will assemble immediately – following the instructions in the corresponding stage – and other pieces that you should store safely to one side, for use in future assembly stages.

Left and Right! When building your Jaguar, the left or right hand side refers to each side as you are sitting in the car.



WARNING: Some parts are assembled using magnets. These magnets can cause serious injury if they are swallowed. Keep away from children. If you suspect a magnet has been swallowed, seek medical help straight away.

Stage 32: Steering System Components

In this first stage of pack 5, you will add components for the steering system to the subframe, and add further components to the engine, before fitting the engine to the subframe.



STAGE 32 PARTS LIST

Name
Steering column assembly
Rack mountings x2
Water pump
Steering rack assembly
Radiator hose
Anti roll-bar links x2
Anti roll-bar mountings x2
Anti-roll bar
Steering rack mounting
Water hose
Screws type AM01 x5
Screws type AG04 x3
Screws type AM16 x3
Screws type AM17 x3
Screws type AG06 x3
Screws type AG08 x5

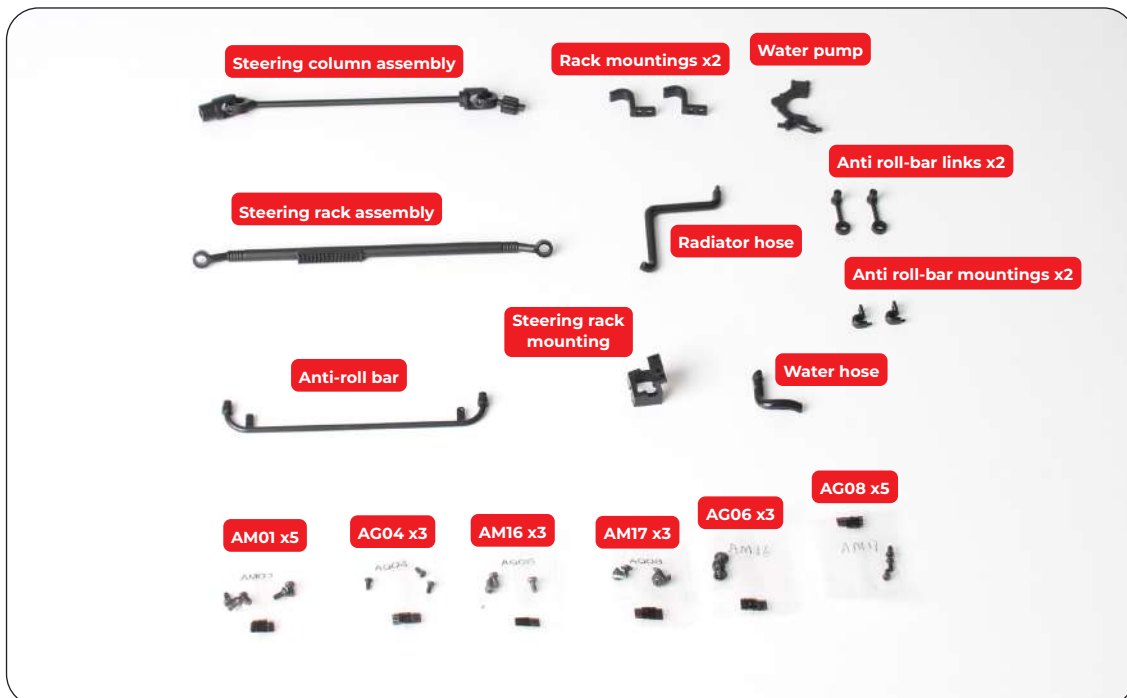

Stage 32: Steering System Components

STEP 1



Take the anti-roll bar and push one of the anti-roll bar links over the pin at one end. Make sure the pin on the link faces the anti-roll bar.



Secure the link with an AG08 screw.



Repeat the process to fit the second link on the opposite end.



Position the anti-roll bar on the front of the subframe, within the triangles formed by the diagonal stays at the front of the subframe.

Stage 32: Steering System Components



5
Locate the flat tabs on both ends of the anti-roll bar on the supports on the subframe.



6
Feed the pins on the end of the links into the holes in the bottom wishbone.

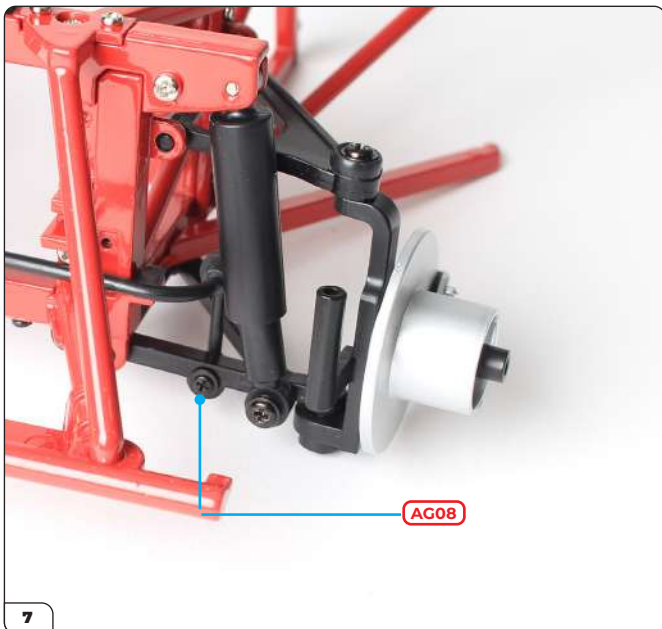

7
Secure the link from the front using an AG08 screw.

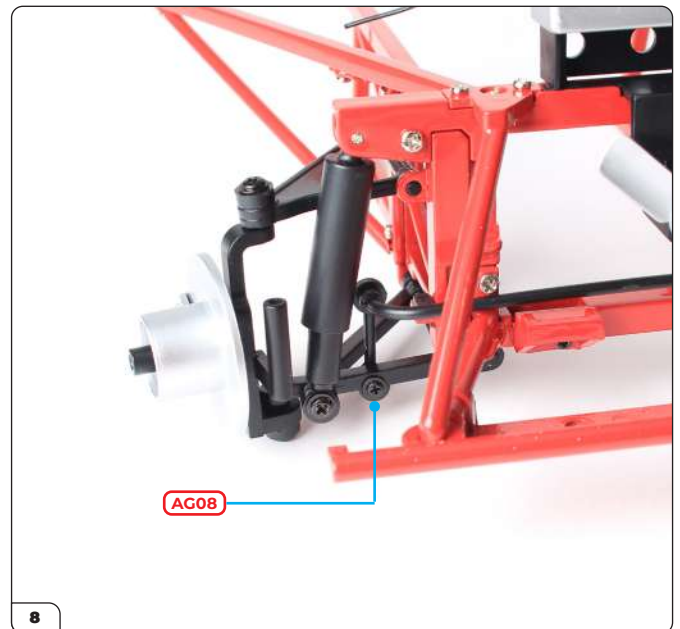

8
Fit the link on the other end of the anti-roll bar in the same way, securing it with another AG08 screw.

Stage 32: Steering System Components



Take one of the anti-roll bar mountings and fit it over the anti-roll bar, lining up the hole and the pin. Note: you may need to file a little excess plastic off the pin and/or clean any flash or paint from the hole to ensure a good fit.

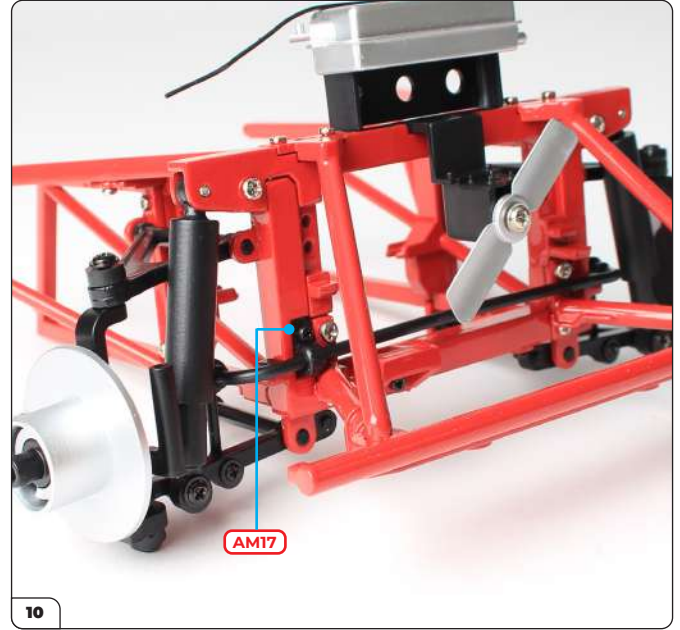

Secure the mounting in place with an AM17 screw.

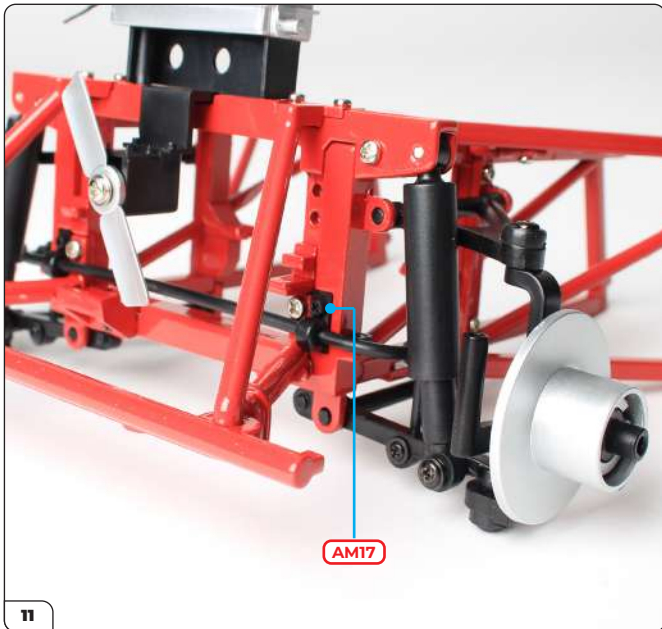

Repeat the process on the opposite end of the anti-roll bar, securing the second mounting in place with another AM17 screw.

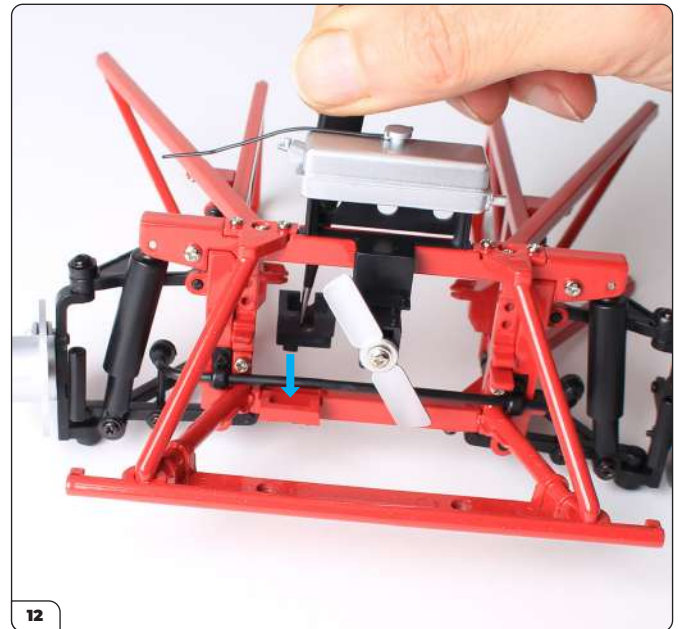

Take the steering rack mounting and align the pins on the underside with the matching holes in the subframe.

Stage 32: Steering System Components

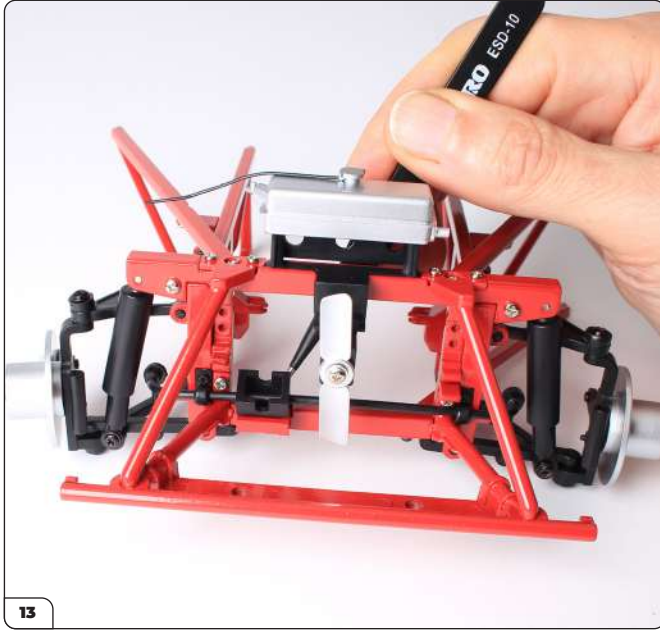

Press the mounting onto the subframe

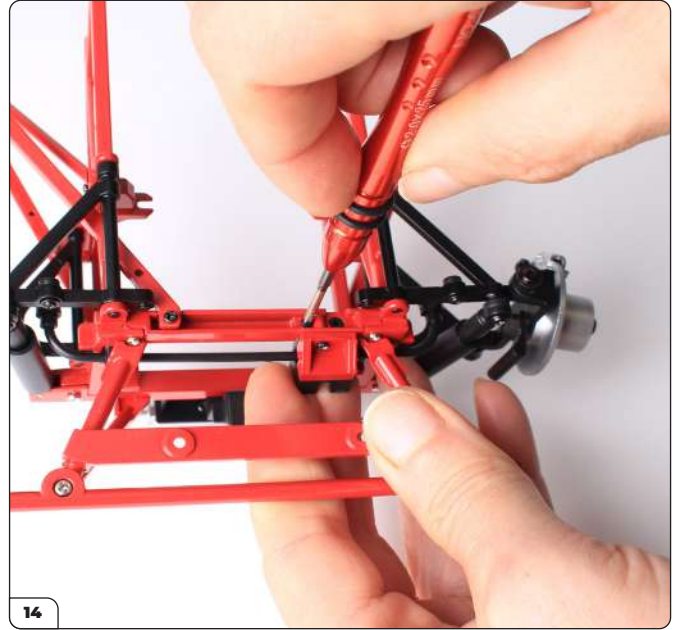

Secure in place from the underside using an AG04 screw.



Take the right-hand lower brace from stage 26 and fit it across the subframe with the screwhole in the end aligned with the second screwhole on the steering rack mounting.



Secure the right-hand lower brace to the steering rack mounting using an AG04 screw. Be careful not to over tighten this screw.

Stage 32: Steering System Components

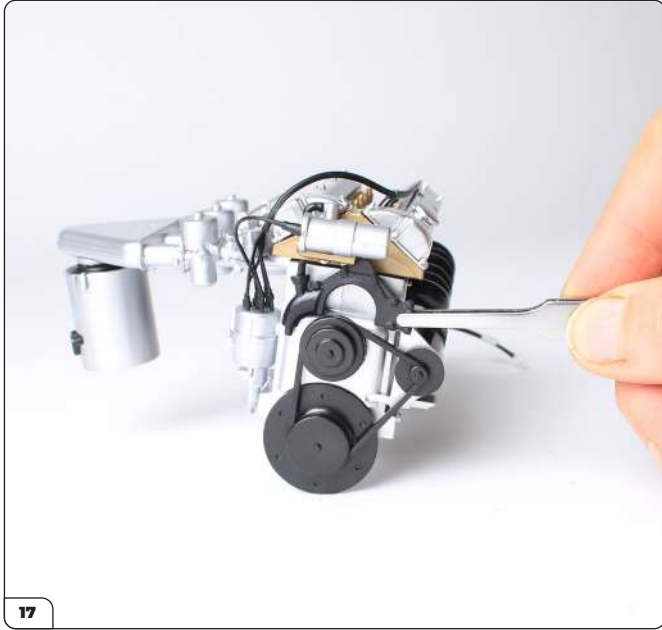

Now take the engine assembly and position the water pump above the engine pulleys as shown.



Fit the water pump behind the uppermost pulley.

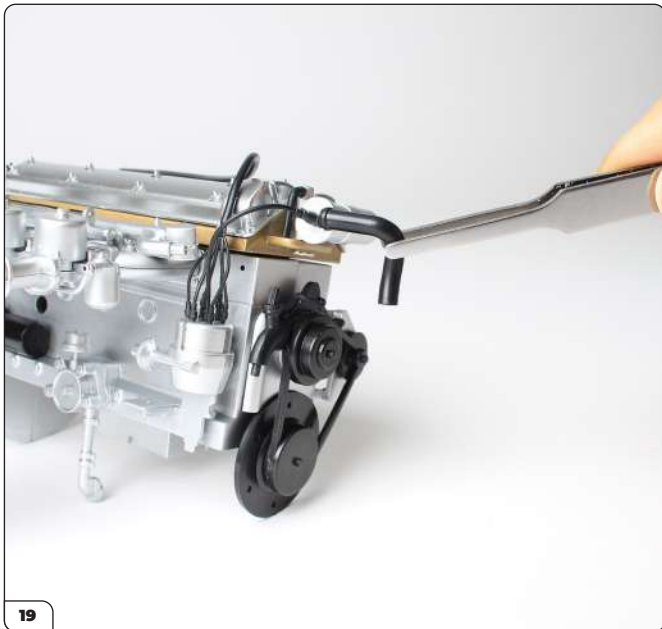

Fit the water hose by pushing one end over the pin on the water pump, and tuck the other end behind the plug leads.

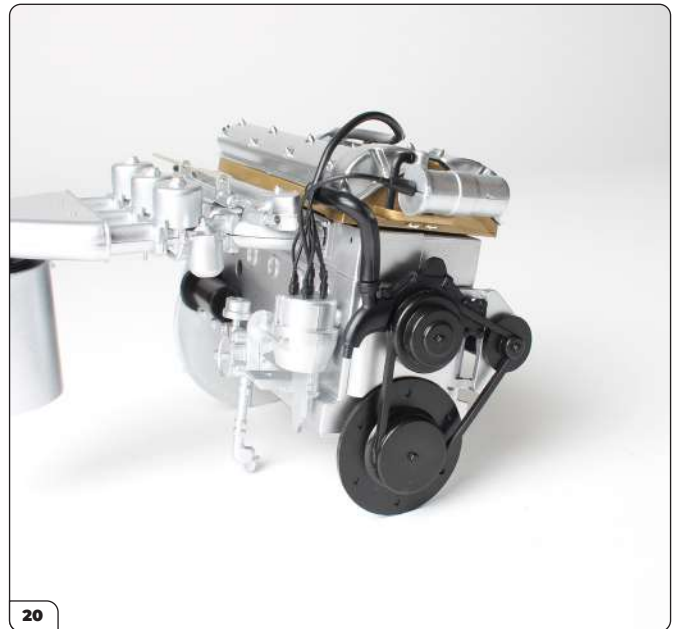

This is how the water hose should look once fitted.

Stage 32: Steering System Components



Returning to the subframe assembly, feed the steering column assembly through the subframe until the gear at the end of the steering column sits in the steering rack mounting (see step 22).

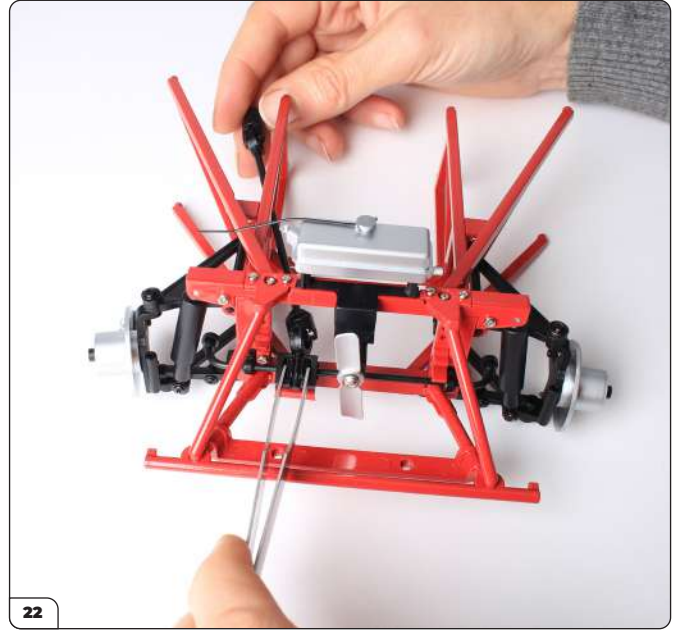

Press the gear into the mounting.



Now feed the steering rack assembly through the triangular braces at the front of the subframe. Check that the teeth on the rack are positioned so that they will align with the gear.
Note: when the wheels are pointing straight ahead, the flat side of the 'D' on the end of the steering column assembly (opposite the gear) should be level and facing upwards (inset).

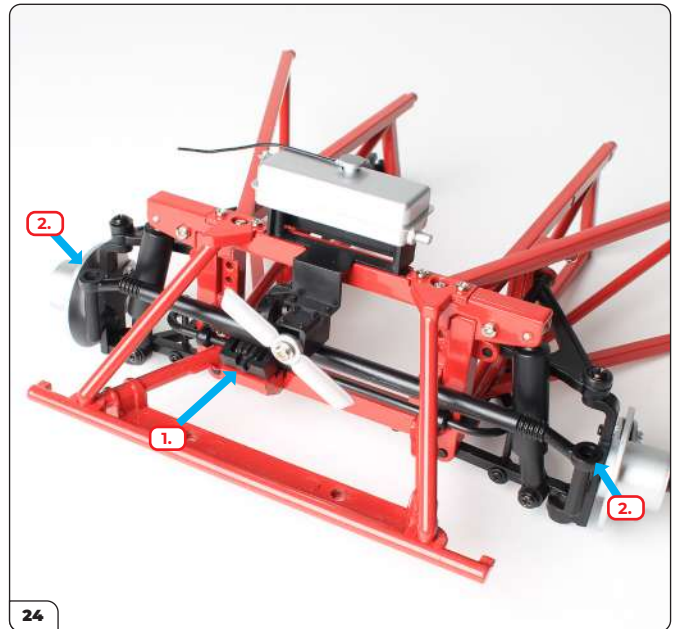

Check that the teeth on the rack are positioned so that they align and mesh with the gear (arrow No 1). Fit the ends of the steering rack over the posts on the steering uprights (arrow No 2).

Stage 32: Steering System Components

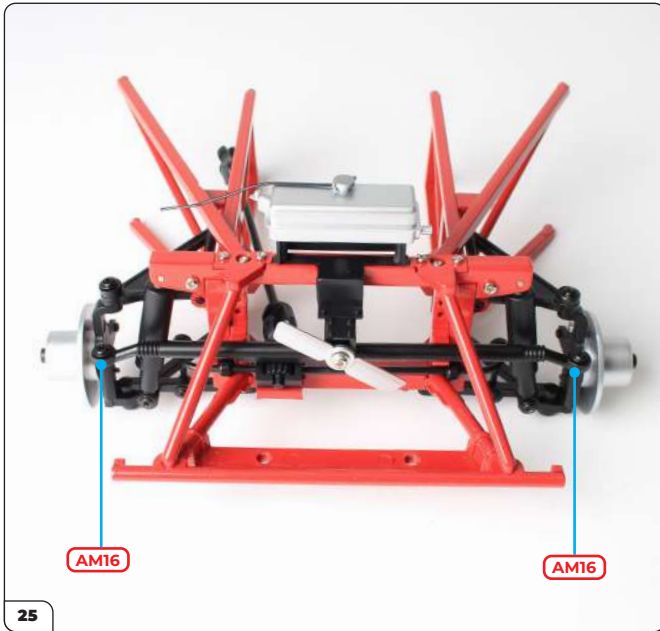

Secure the steering rack to each upright using an AM16 screw

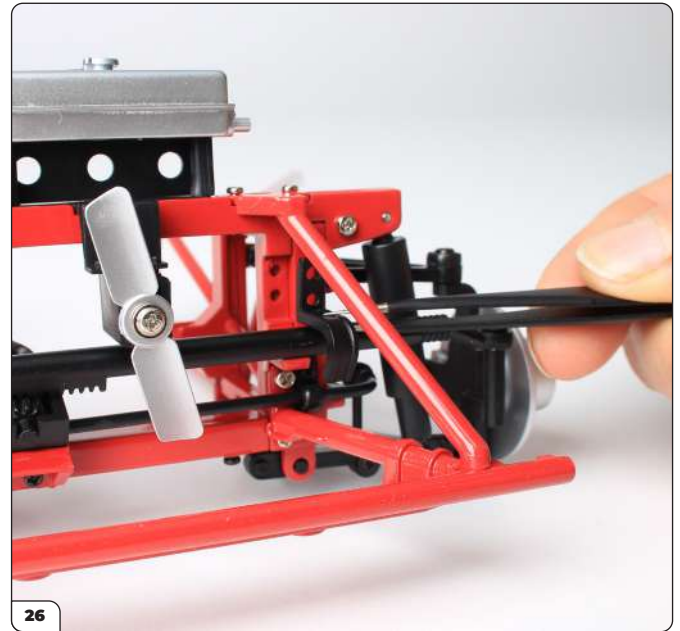

Take one of the steering rack mountings, using tweezers, position it over the steering rack, lining up the two screwholes with the holes on the subframe.

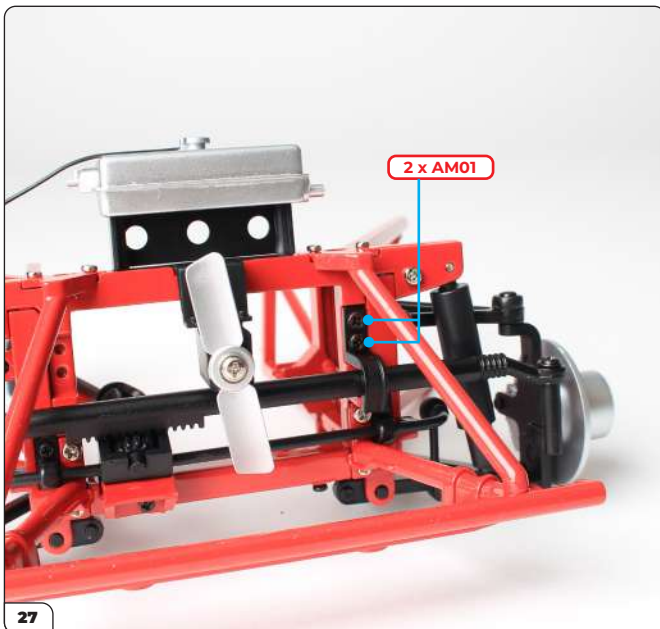

Secure the mounting in place using 2 x AM01 screws.

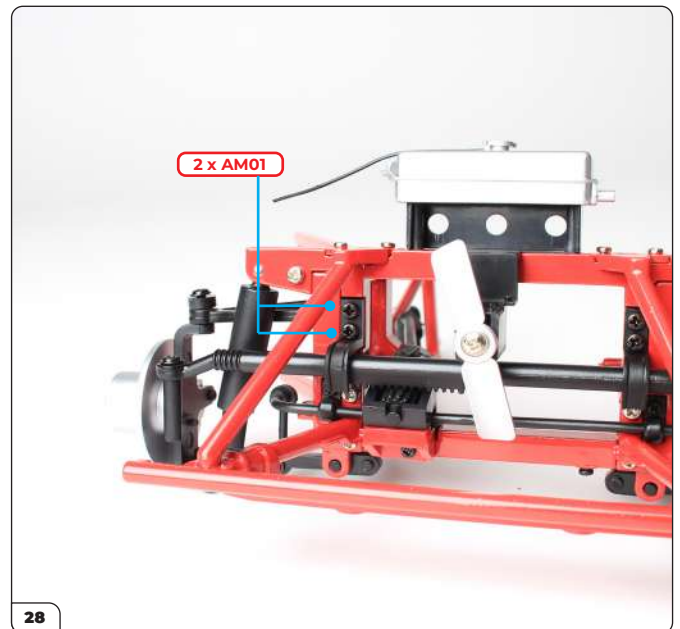

Repeat steps 26 & 27 to fit the other mounting to the right-hand side.

Stage 32: Steering System Components

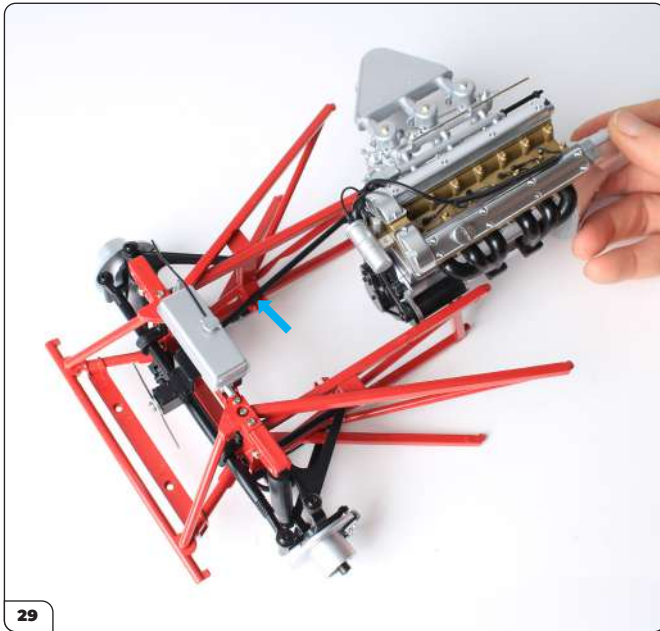

Now it's time to fit the engine to the subframe. Start by lining up the engine within the rear of the subframe. Make sure the steering column is kept to the side and out of the way, resting on the mounting point indicated.

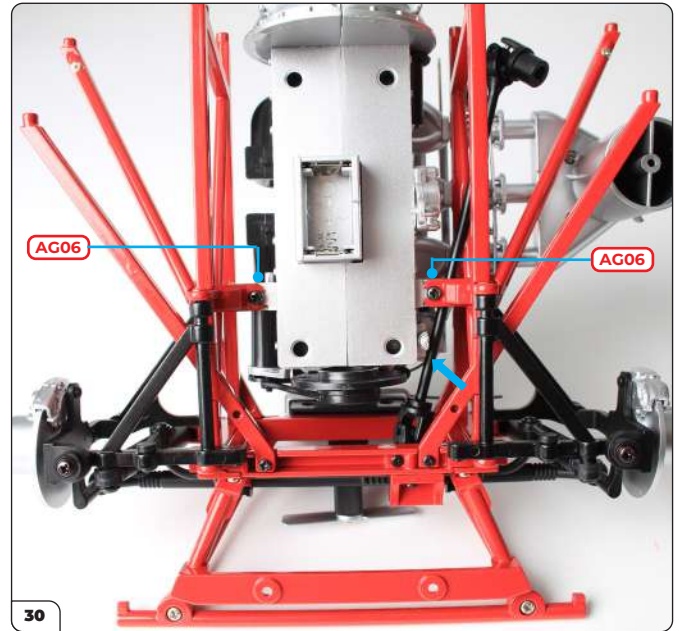

Carefully slide the engine into place so that the engine mounts line up with the mounting points on the underside of the subframe. Secure the engine mounts on both sides using 2 x AG06 screws. Note the angle of the steering column (arrow).

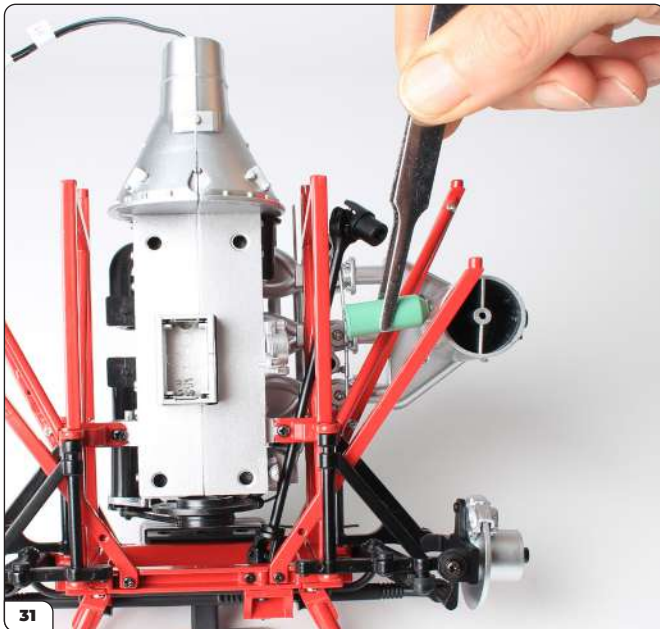

Take the oil filter supplied with stage 26 and push it carefully onto the face of the oil pump, as shown.

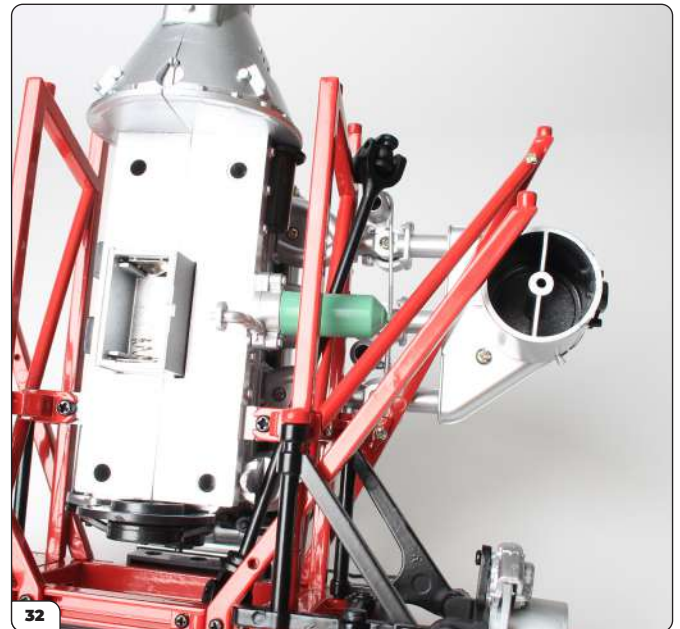

This is how the oil filter should look when correctly fitted.

Stage 32: Steering System Components

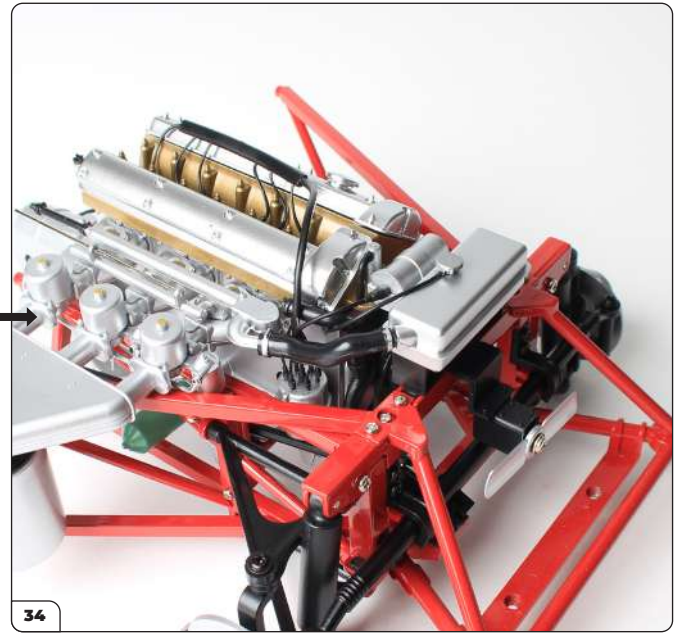
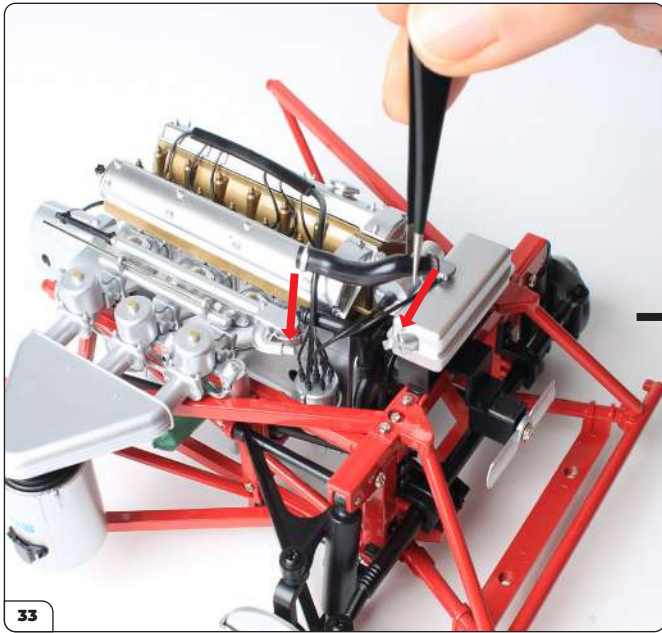

Fit the hose from stage 30 , pushing one end into the expansion tank and the other end into the water outlet pipe.



Locate the end of the hose leading from the filler cap on the expansion tank...

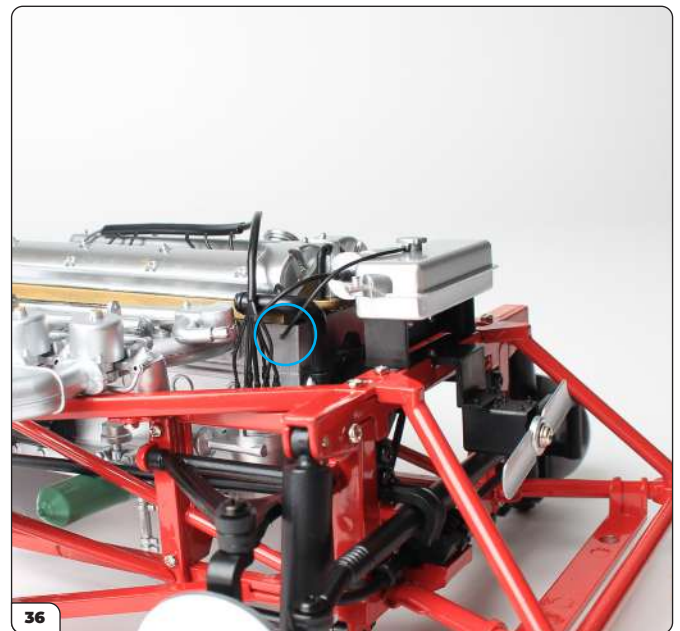

... and push it into the tiny hole in the engine block (circled).

Stage 32: Steering System Components

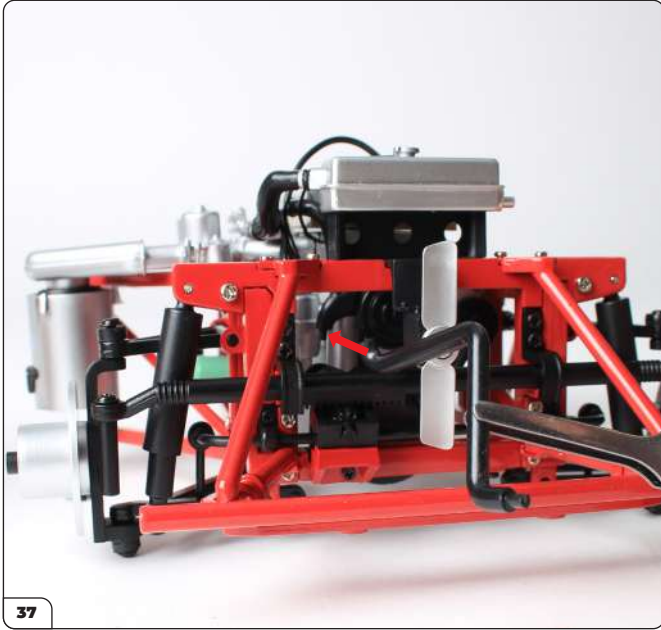

Take the radiator hose and feed it through the front of the subframe.

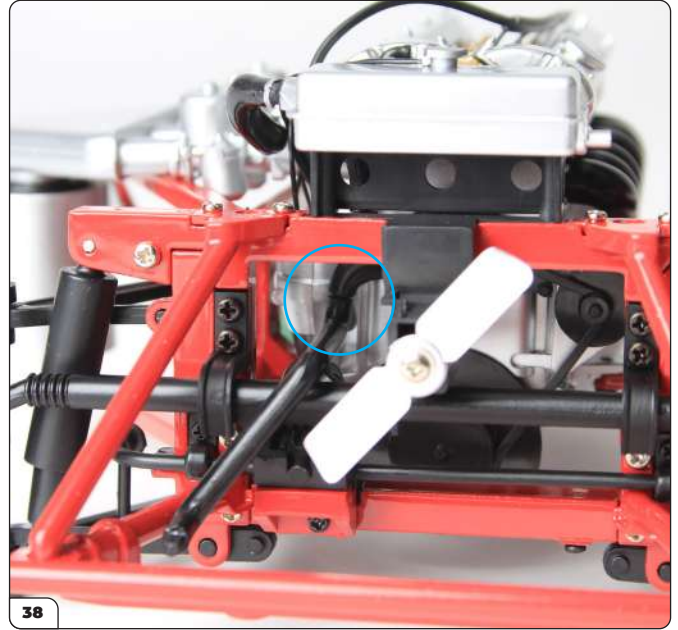

The innermost end fits on the pin at the end of the water pump, leaving the 'L' shaped end projecting towards the front of the subframe.

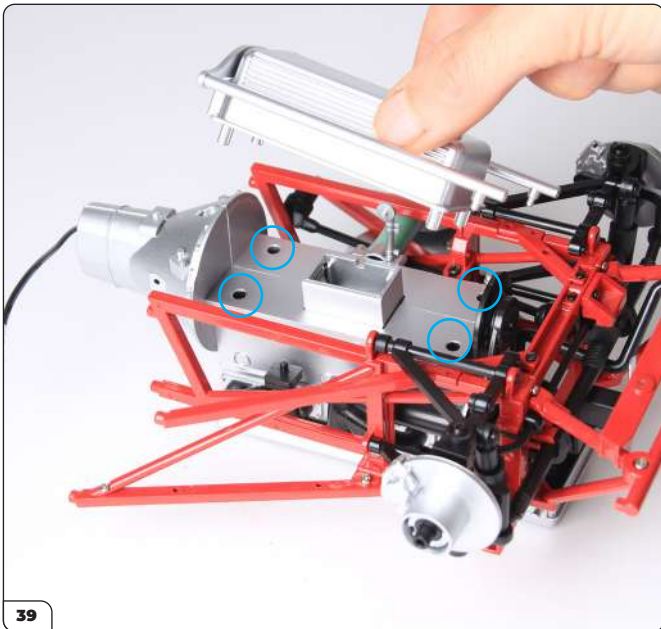

Lower the sump onto the engine block, aligning the four corner pins with the corresponding holes (circled). If the sump does not fit easily, carefully scrape some paint off the four corner pins.

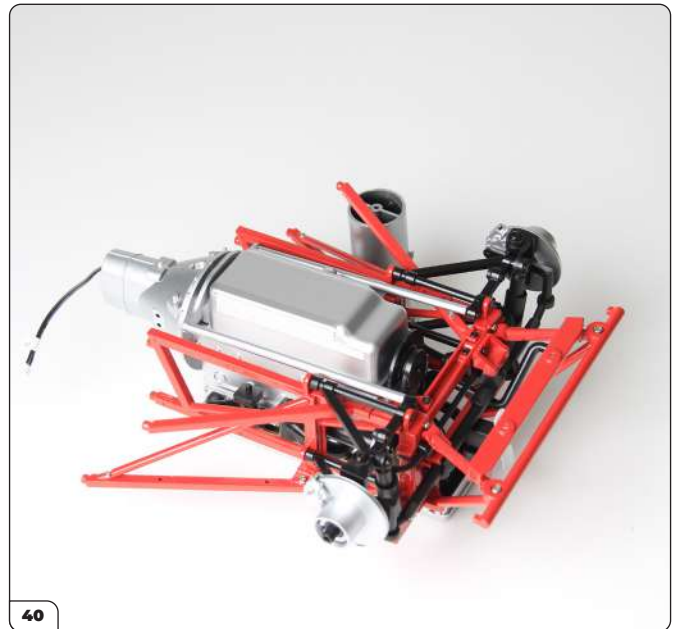

Push the sump firmly to fit. The oil pipe clips into the left side of the sump, and the pegs on the two torsion bars press into holes in the subframe.

Note: the sump is a push-fit attachment so that it can easily be removed to access the batteries.

Stage 32: Steering System Components

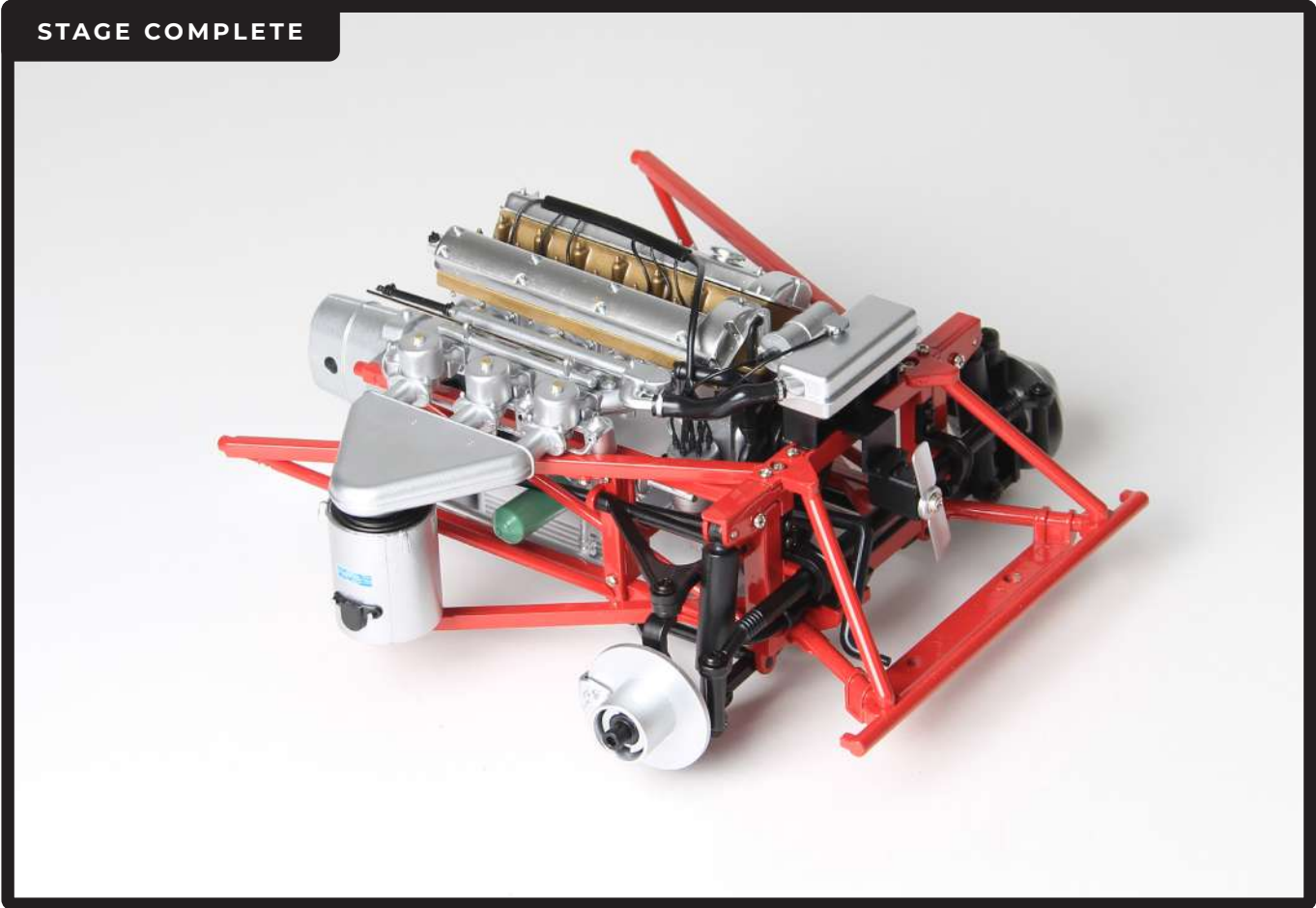

Stage 33: Cooling System Components

In this next stage, you'll assemble the radiator before fixing it to the subframe.



STAGE 33 PARTS LIST

Name
Radiator (front section)
Radiator (back section)
Cowl
Hose
Screws type AG04 x5
Screws type AG06 x3



Stage 33: Cooling System Components

STEP 1

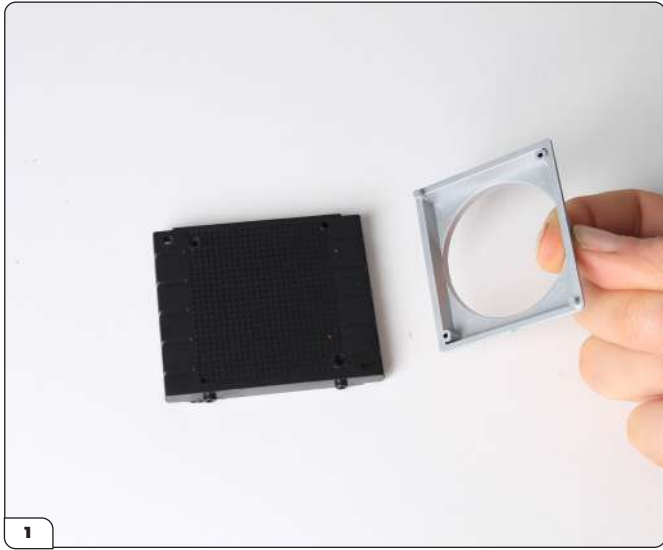

Align the two pins on the cowl with the corresponding holes on the radiator front section.

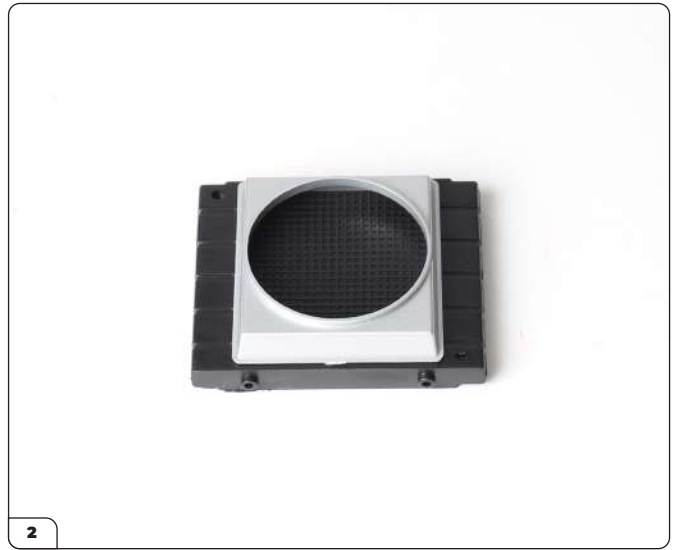

Press the two parts firmly together.

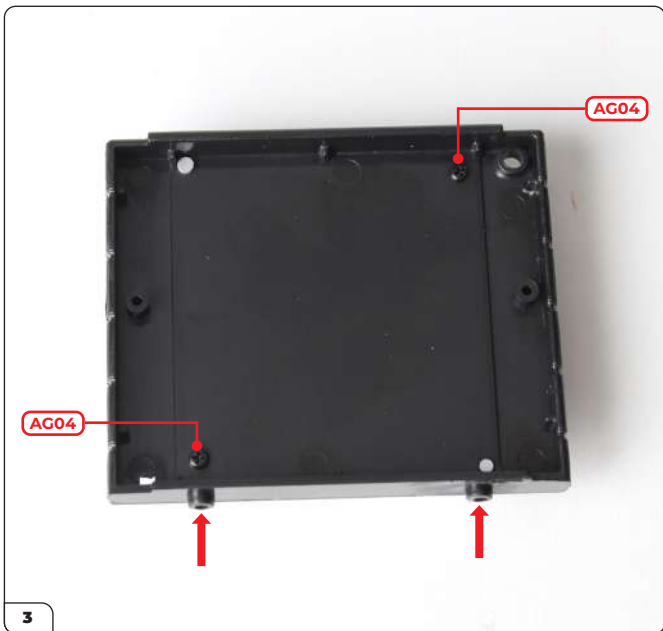

Turn the radiator/cowl assembly over so the reverse side is facing you and note that there are two lugs along one edge (arrows). Secure the cowl to the radiator with 2 x AG04 screws.



Align the two holes on the radiator back section with the raised screw holes on the radiator/cowl assembly (circled). There is only one way to fit these parts. If they don't fit, rotate the radiator 180° and try again.

Stage 33: Cooling System Components

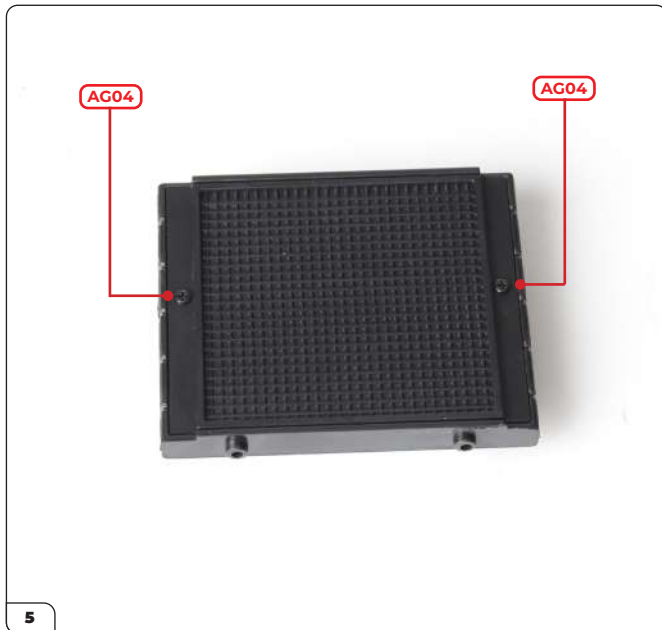

Secure the two parts together using 2 x AG04 screws.



With the cowl facing up, take the hose and push the end with the pin into the hole in the radiator.



The hose should face this direction.

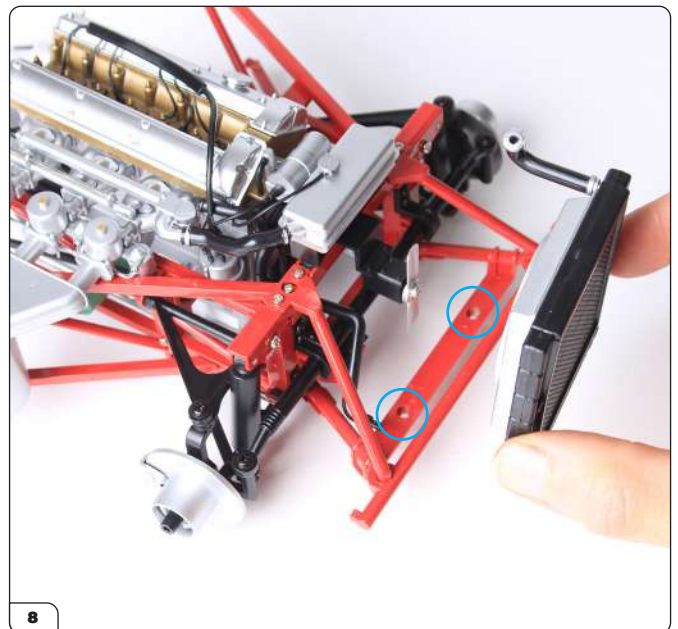

Align the two lugs on the bottom of the radiator (see step 3) with the two holes in the bottom bar of the front subframe (circled).

Stage 33: Cooling System Components

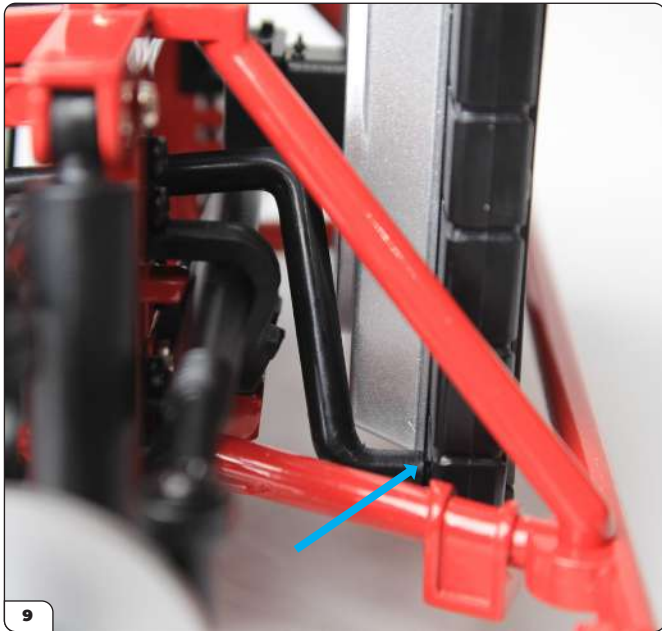

Fit the bottom hose from the water pump into the hole in the back of the radiator (arrow).

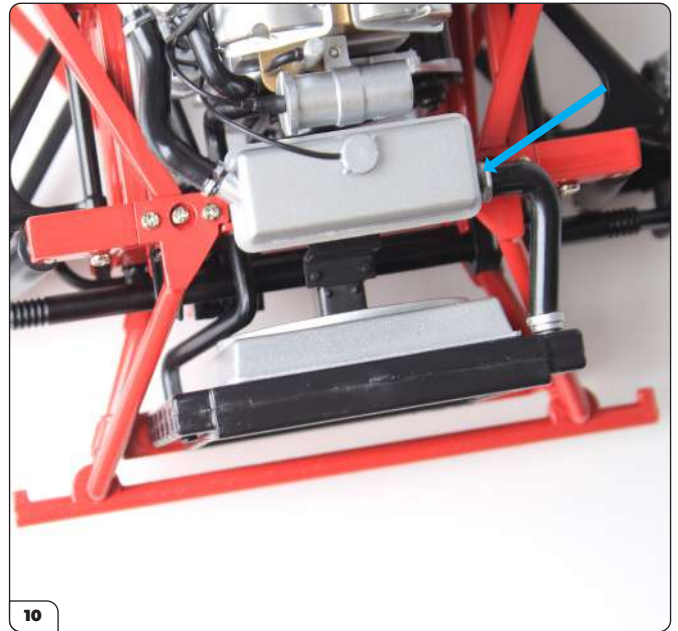

Fit the top hose installed on the radiator into the side of the expansion tank (arrow).

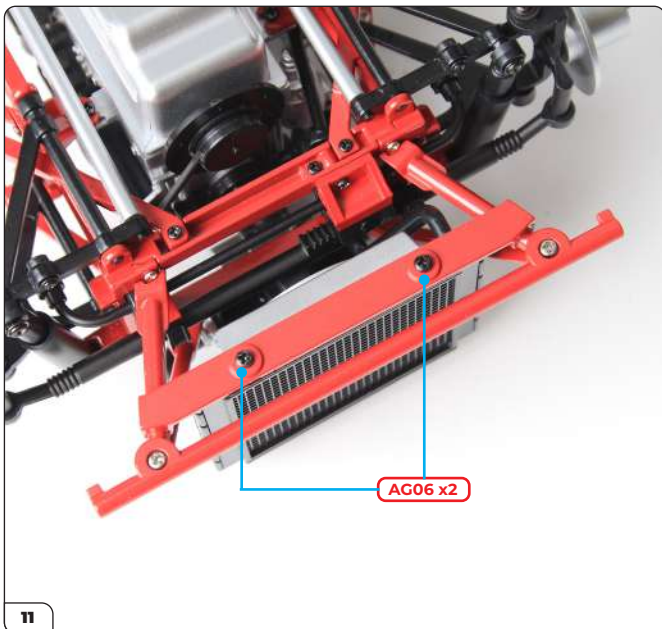

Secure the radiator in place from the underside using 2 x AG06 screws.

Stage 33: Cooling System Components

STAGE COMPLETE

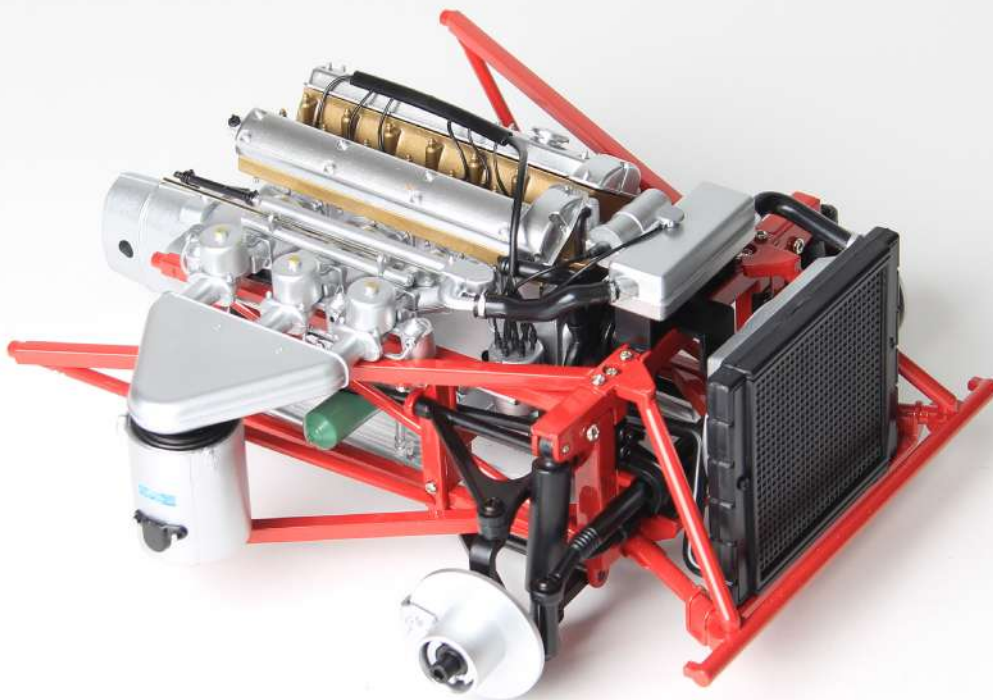

Stage 34 : The Front Bulkhead

Unpack the bulkhead. Check that the subframe fits into the bulkhead before adding any of the detail parts. Refer to stage 35, step 1 (photos 3, 5 and 7). Remove paint from the pins on the subframe if necessary. Once you're happy with the fit, remove the bulkhead and continue with stage 35 to start adding components to it.



STAGE 34 PARTS LIST

Name
Front bulkhead

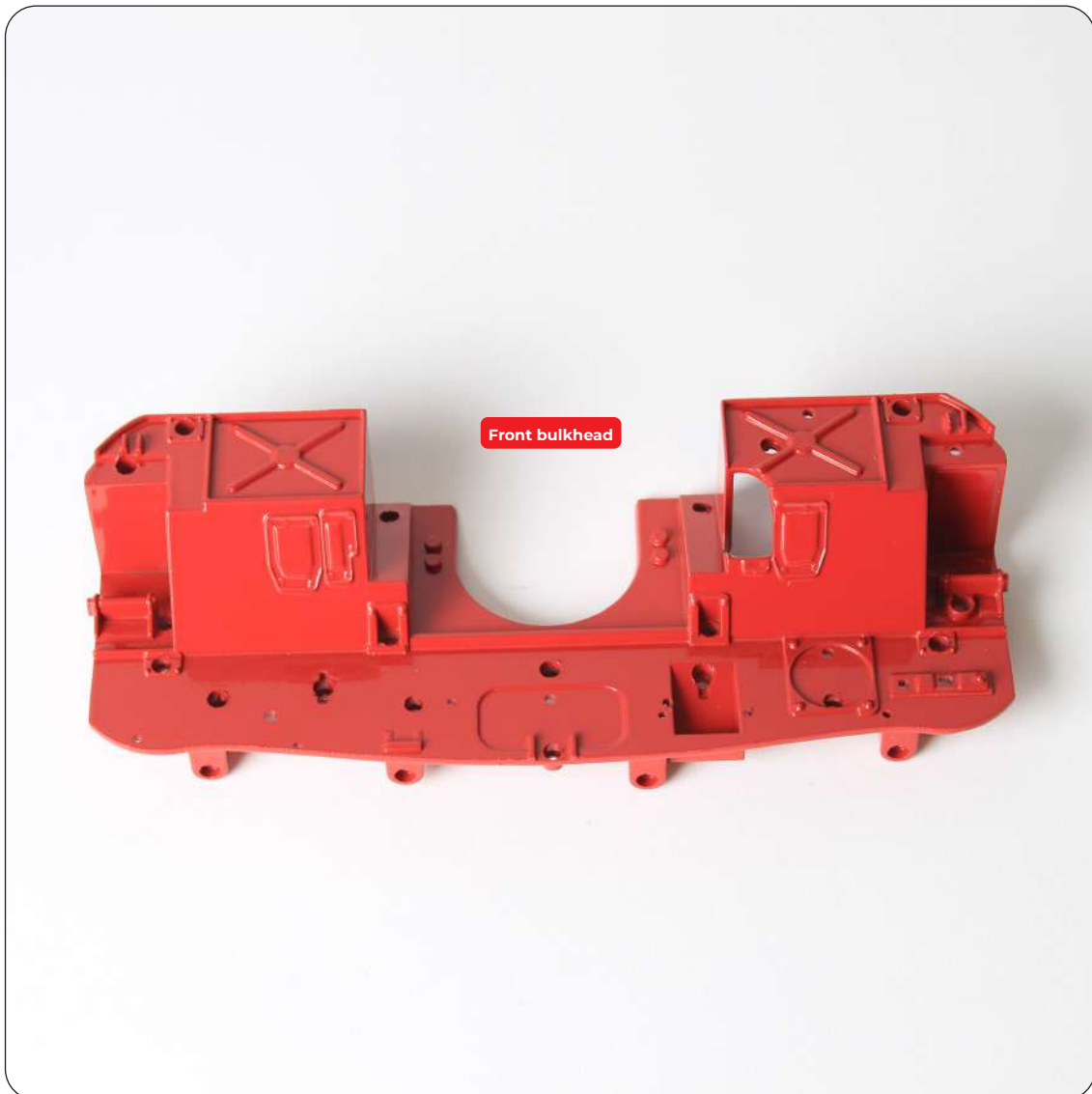

Stage 35: Bulkhead Fittings and Pipework

In stage 35, you'll start fitting components to the bulkhead.



STAGE 35 PARTS LIST

Name
Reservac tank (half)
Brake vacuum hoses
Fuel filter
Reservac tank (half)
Hydraulic and fuel pipes
Fluid reservoirs
Brake servo unit
Clip
Screws type AG02 x2
Screws type AG03 x4



Stage 35: Bulkhead Fittings and Pipework

STEP 1



Take the fuel filter and note the two small holes (arrows). Hook the curved ends of the clip into the holes.



Check that the middle section of the clip fits on the fuel filter as shown (inset arrow). If necessary, secure the clip with a tiny drop of superglue.

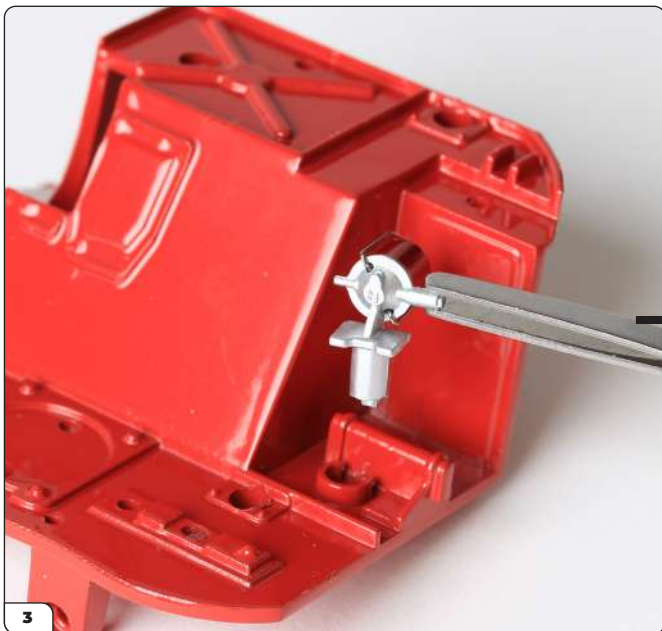

Push the pin on the fuel filter into the keyhole shaped mounting on the bulkhead.

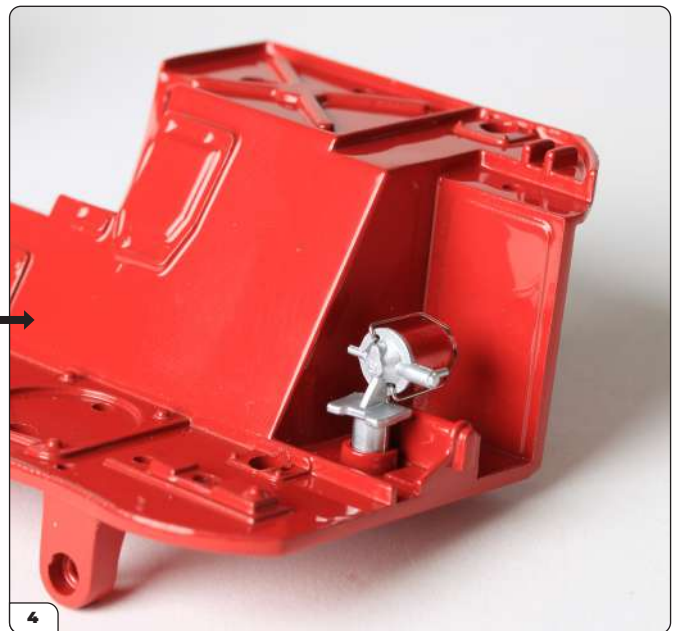

Stage 35: Bulkhead Fittings and Pipework

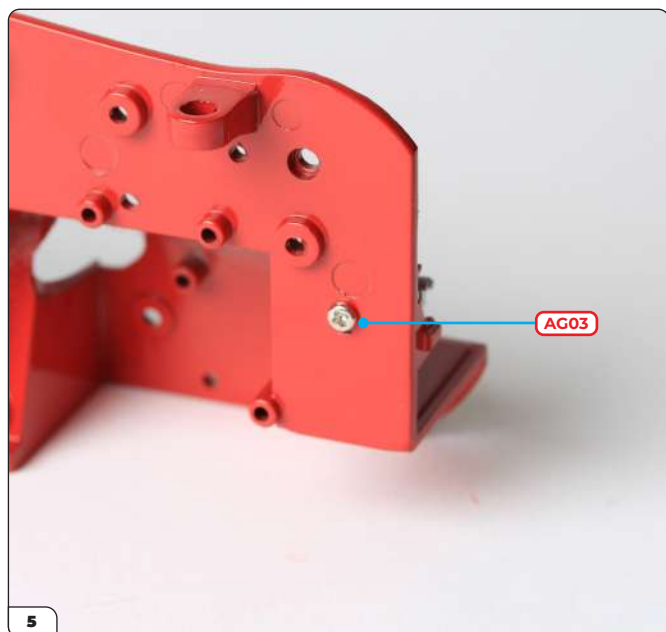

Secure the filter from the reverse side with an AG03 screw.



Align the two halves of the reservac tank, matching up the locating pins and holes.



Press firmly together.



Align the two pins on the reservac tank with the corresponding holes on the bulkhead.

Stage 35: Bulkhead Fittings and Pipework



Press firmly into position.

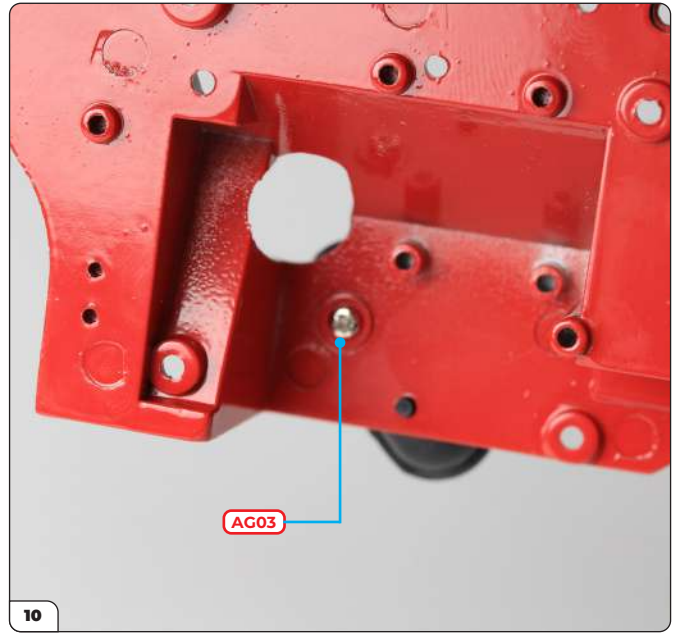

Secure from the reverse side with an AG03 screw.



Align the fluid reservoirs with the mounting holes on the bulkhead.

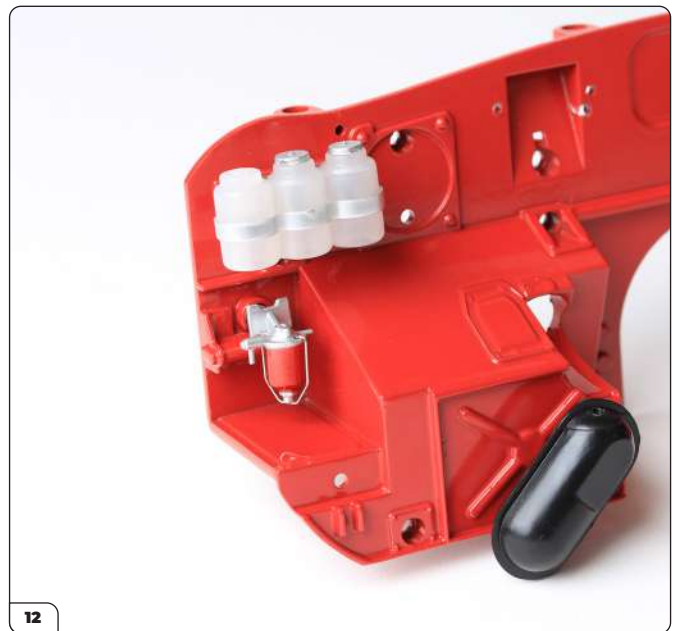

Press firmly into position.

Stage 35: Bulkhead Fittings and Pipework

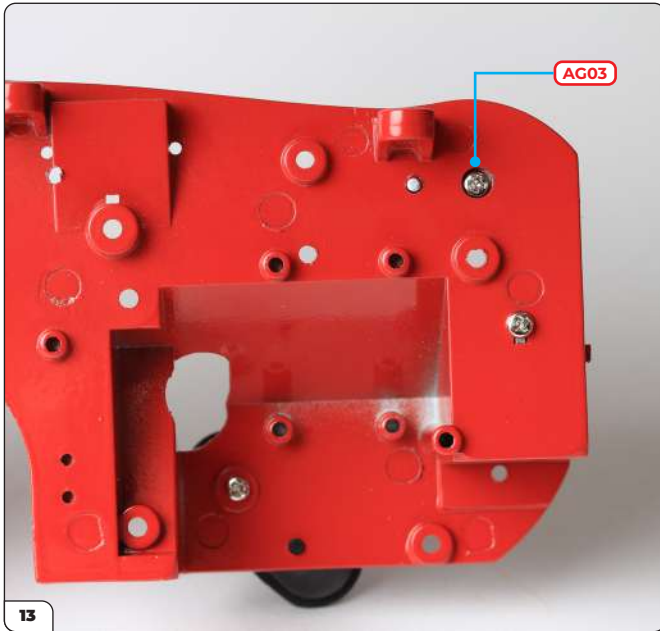

Secure from the reverse side with an AG03 screw.

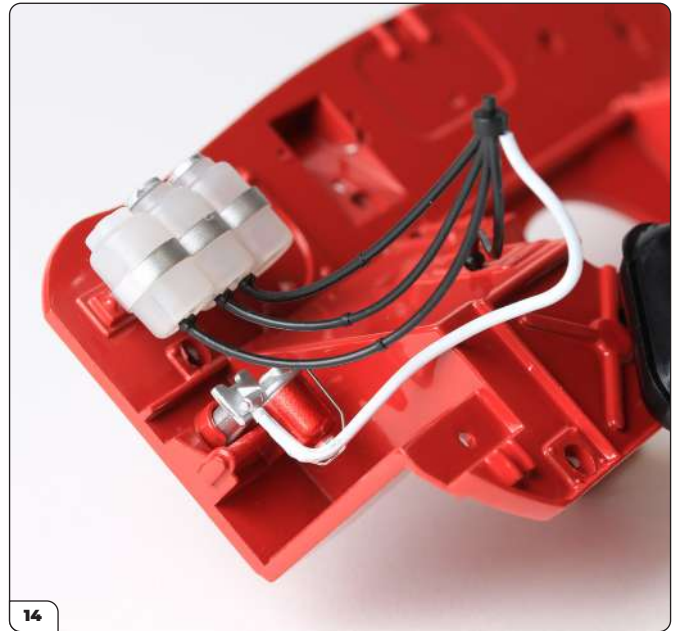

Take the bunch of pipes and hold the outermost, longest black pipe with tweezers. Plug the tip into the outermost fluid reservoir. Plug the next black pipe into the middle fluid reservoir, and then plug the third black pipe into the innermost fluid reservoir. Finally, fit the end of the white pipe onto the pin projecting from the fuel filter.

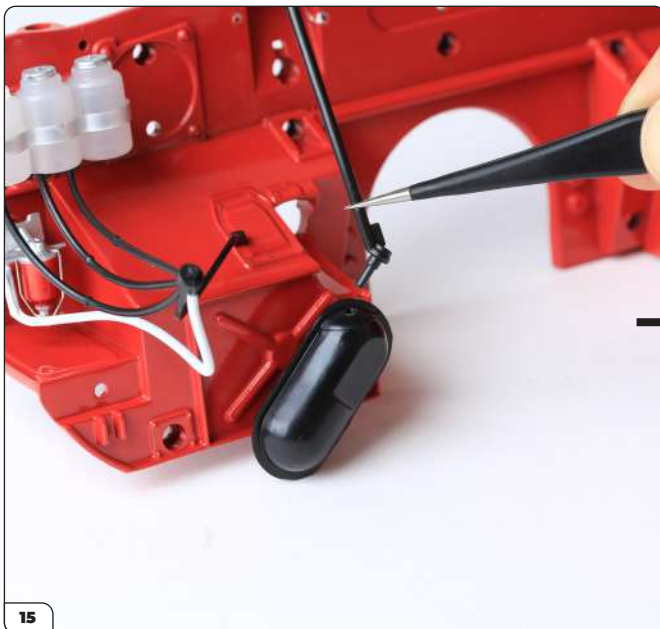

Grip the single end of the brake vacuum hoses with tweezers and plug it into the hole in the Reservac.

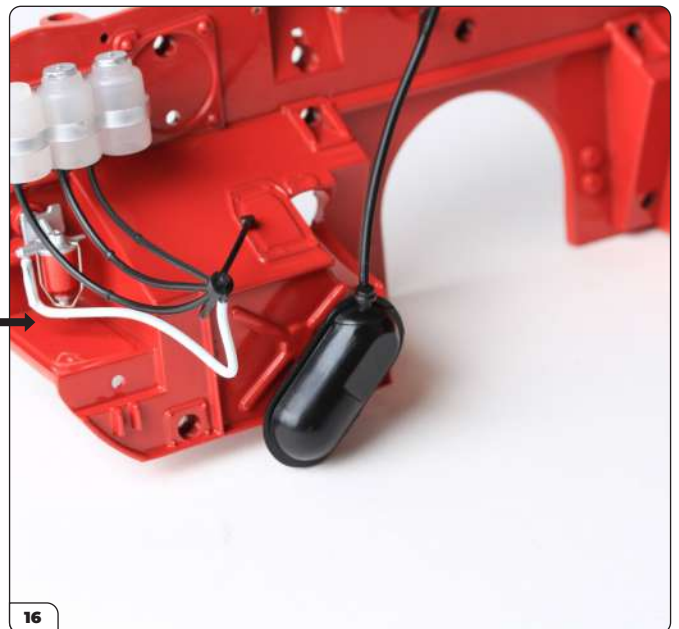

Stage 35: Bulkhead Fittings and Pipework

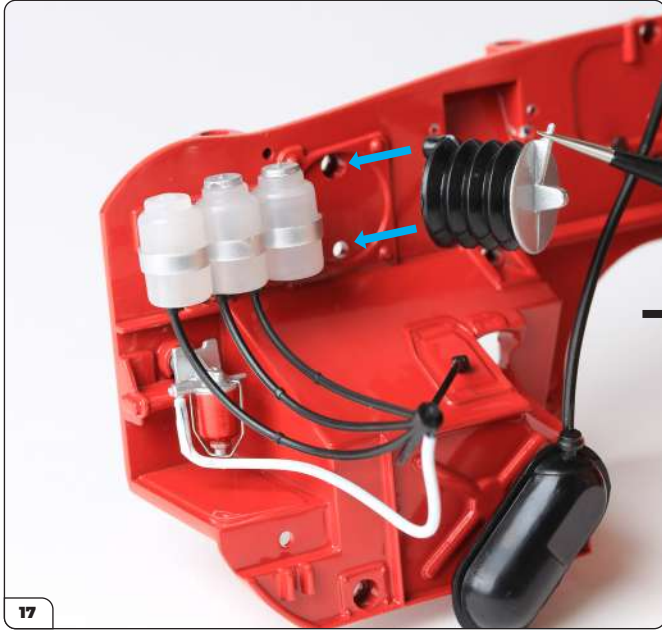

Push the lugs on the brake servo unit into the holes in the circular recess on the bulkhead.

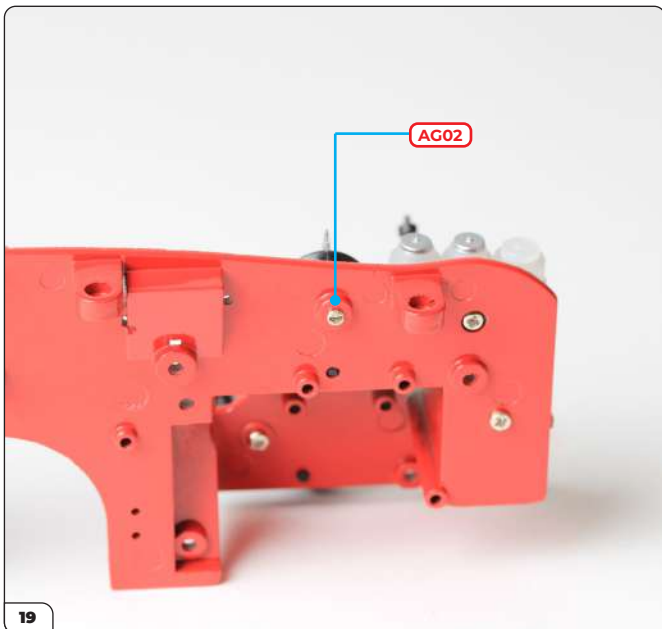
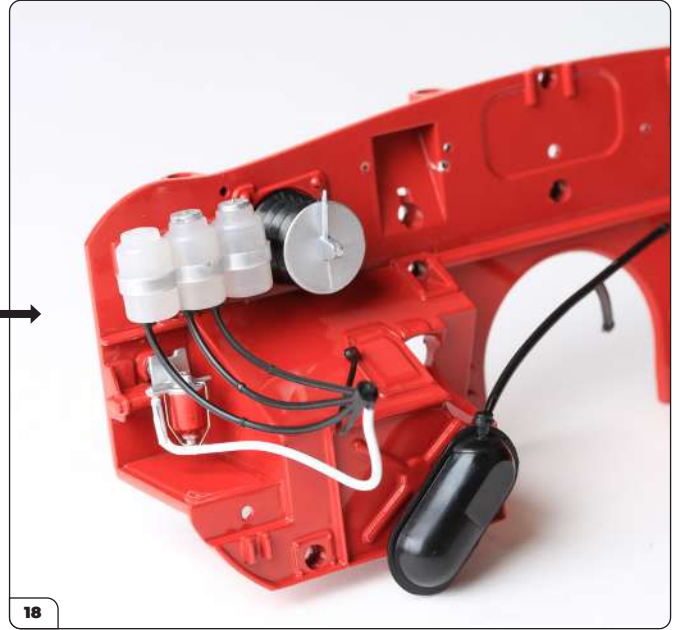

Secure the brake servo unit in place from the reverse side with an AG02 screw.

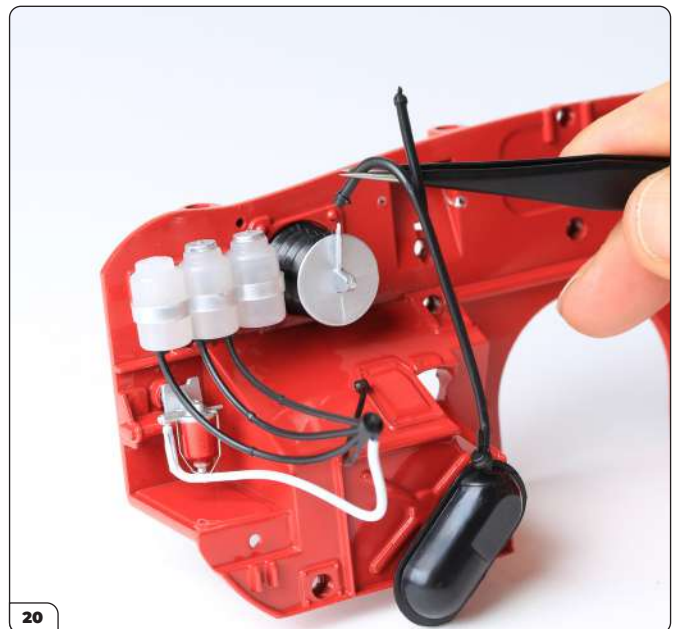

Grip one of the ends of the brake vacuum hoses and plug it onto the pin on the brake servo unit (see picture 21).

Stage 35: Bulkhead Fittings and Pipework



A brake vacuum hose has been connected to the brake servo, leaving one brake vacuum hose to be connected at a future stage.

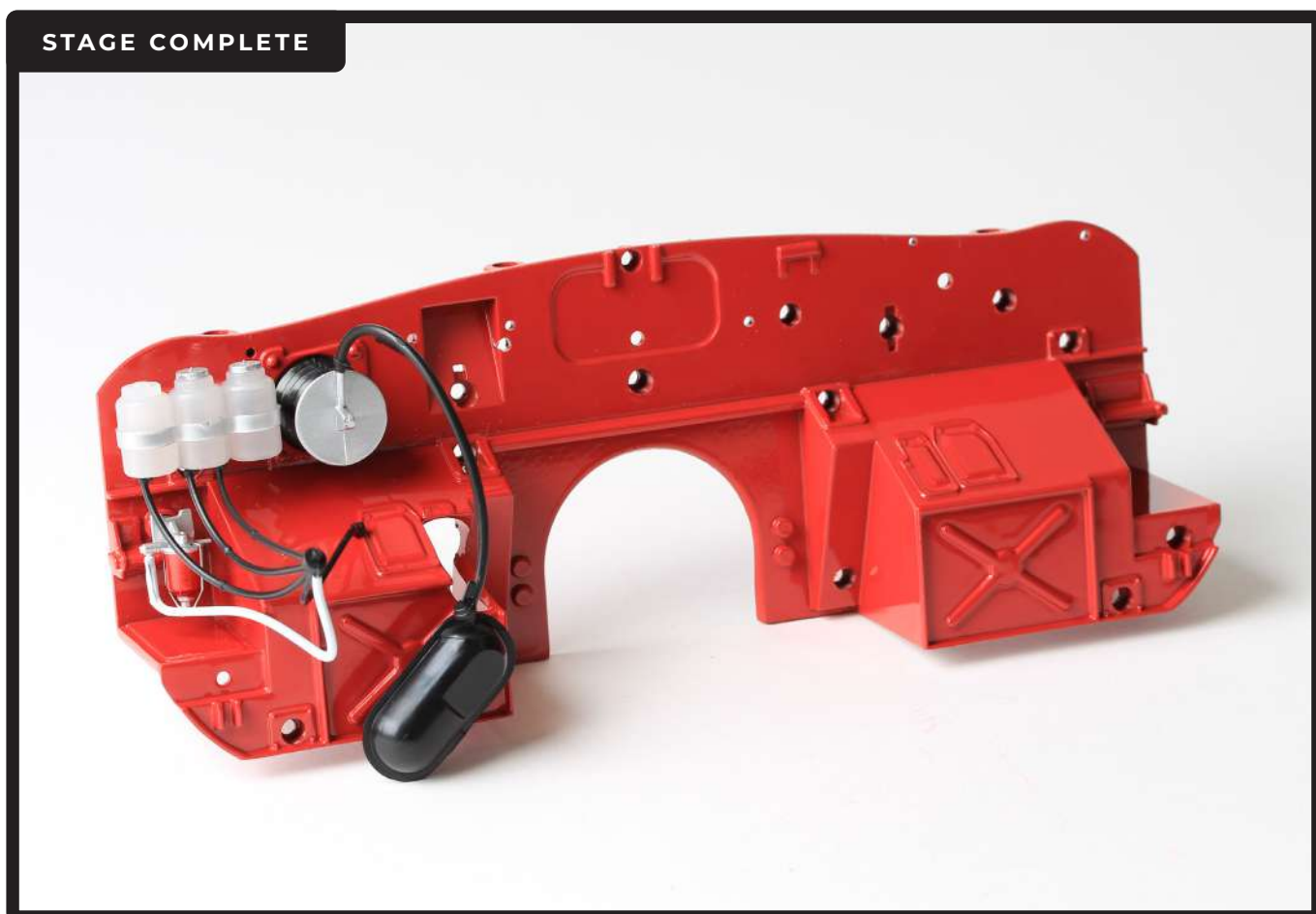

Stage 36: Bulkhead Fittings

Stage 36 continues with assembling and adding more components to the bulkhead.



STAGE 36 PARTS LIST

Name
Heater case
Heater motor
Reservoir bracket
Voltage control unit
Engine stabiliser mounting
Washer reservoir
Throttle linkage
Heater water control valve
Washer cap
Windscreen wiper motor
Washer tube
Screws type AG02 x3
Screws type AG03 x3

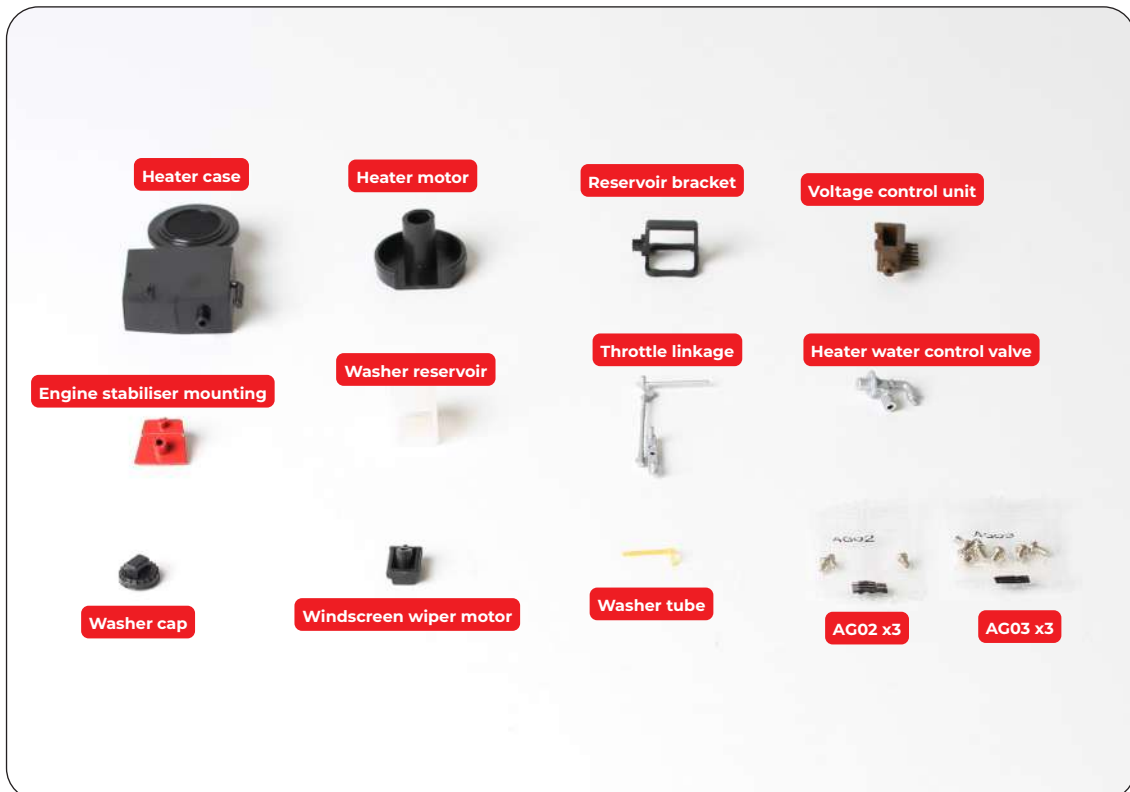

Stage 36: Bulkhead Fittings

STEP 1

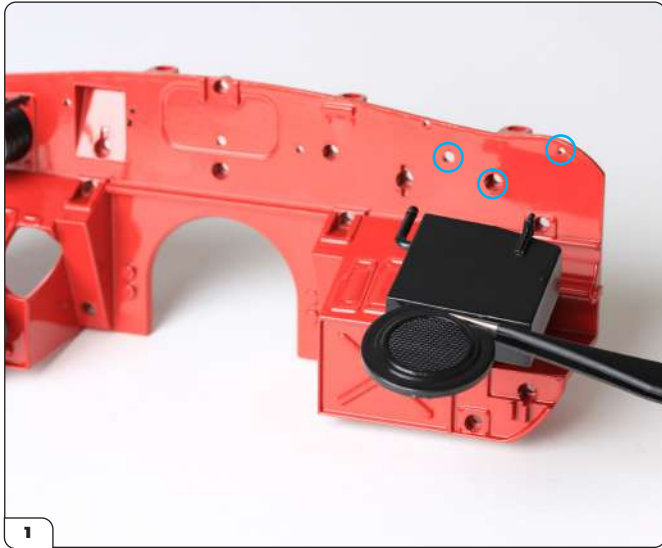

Align the three pins on the heater case with the three holes on the bulkhead (circled).

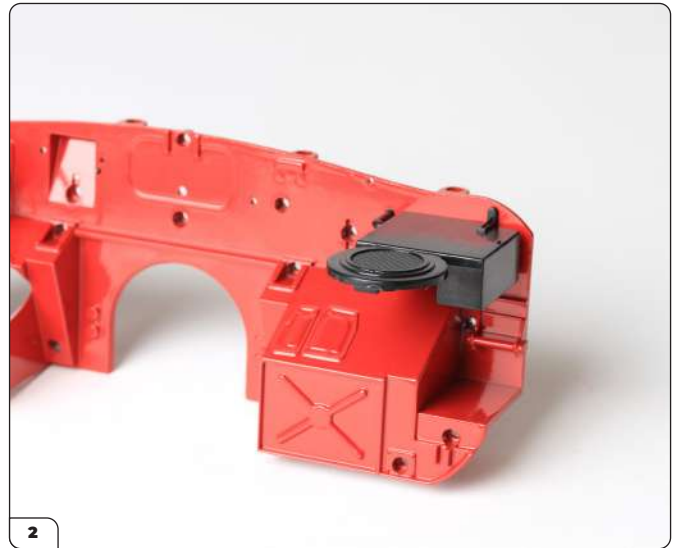

Press firmly into position.

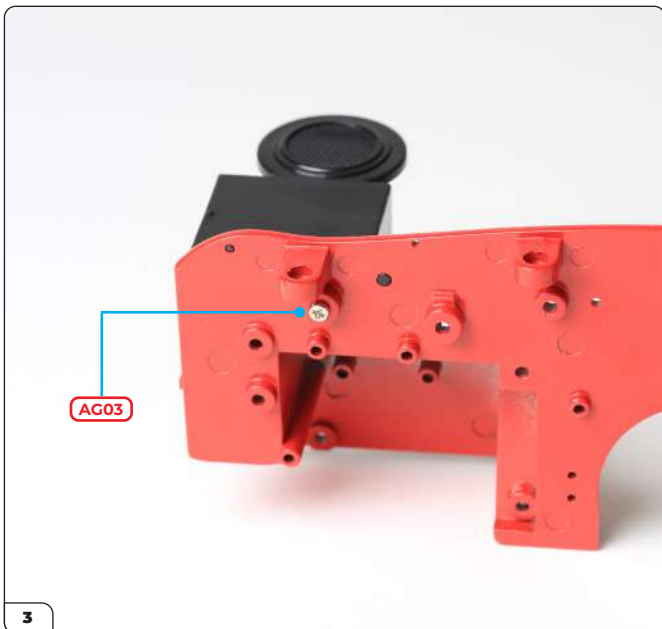

Secure the heater case in place from the reverse side with an AG03 screw.

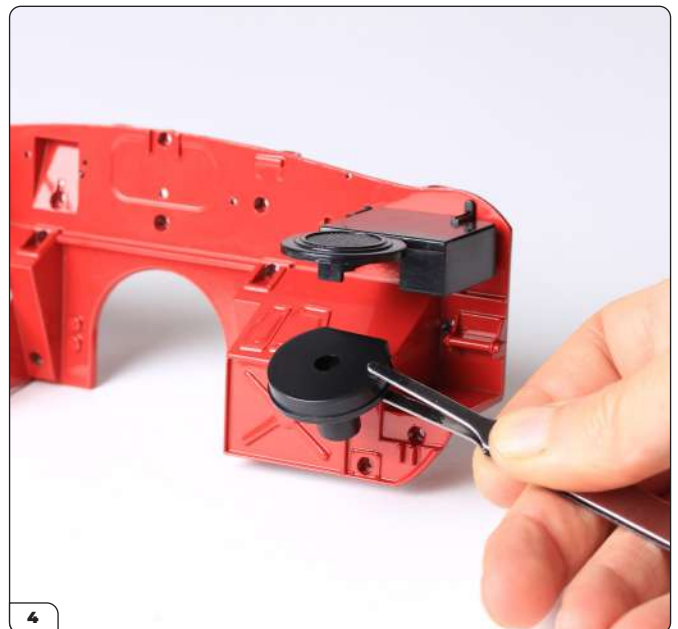

Line up the heater motor with the heater case, checking that the flat edge faces the bulkhead.

Stage 36: Bulkhead Fittings

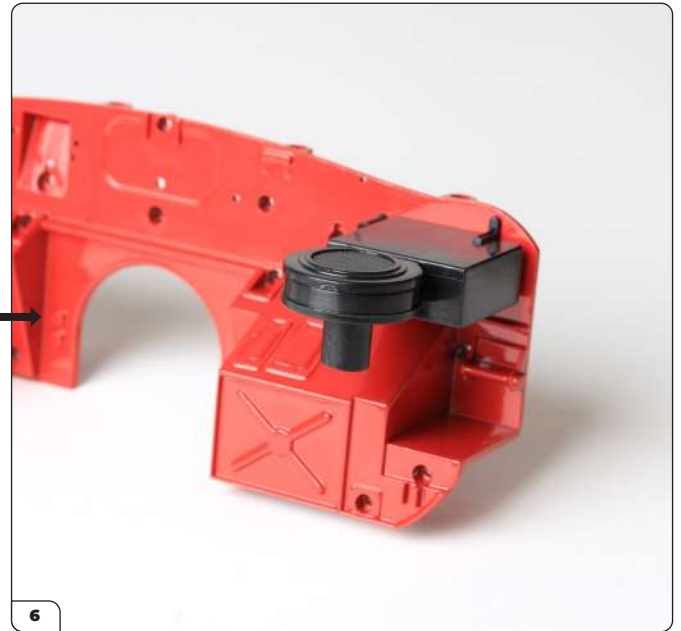
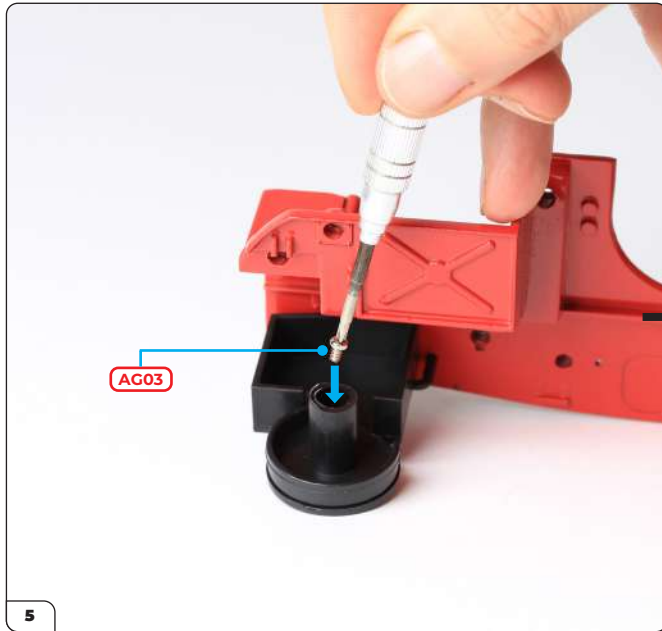

Push the heater motor in place and fit an AG03 screw through the centre of the motor to secure it in place.

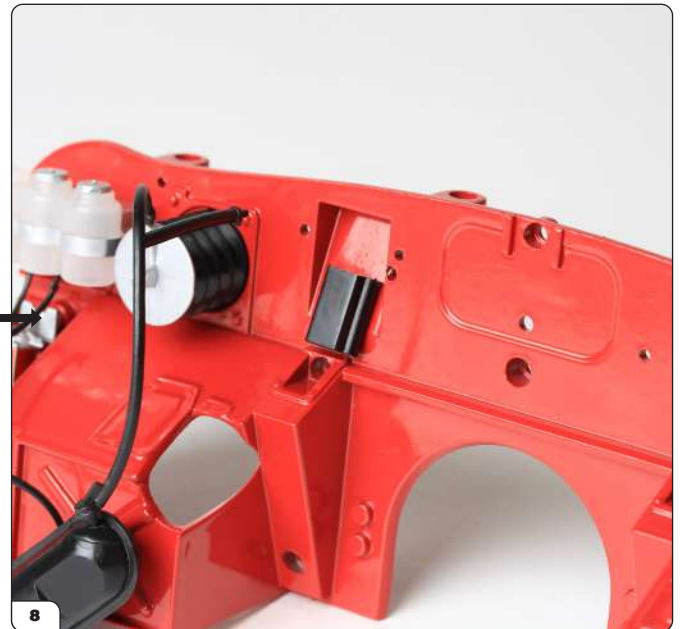
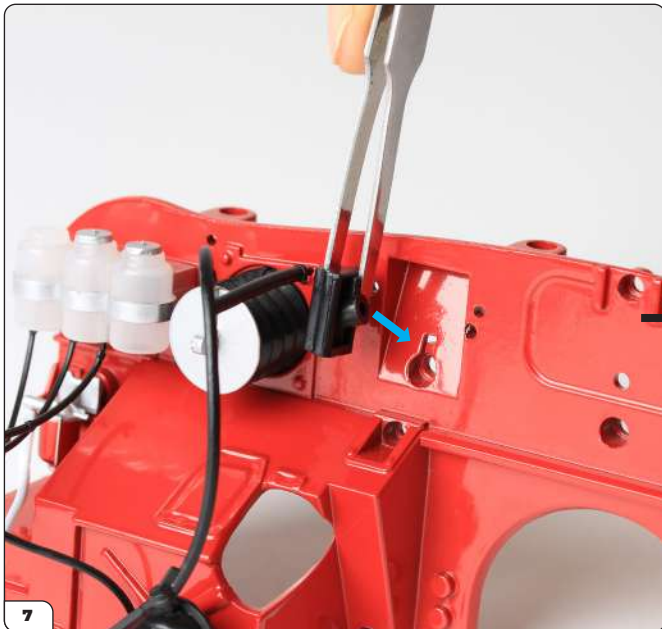

Align the keyhole-shaped lug on the wiper motor with the matching hole in the rectangular recess on the bulkhead.

Stage 36: Bulkhead Fittings

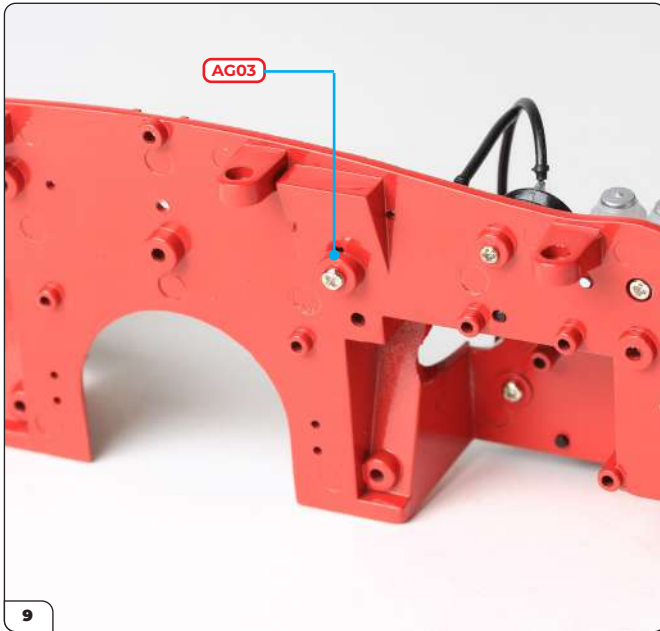

Secure the wiper motor in place from the reverse side with an AG03 screw.

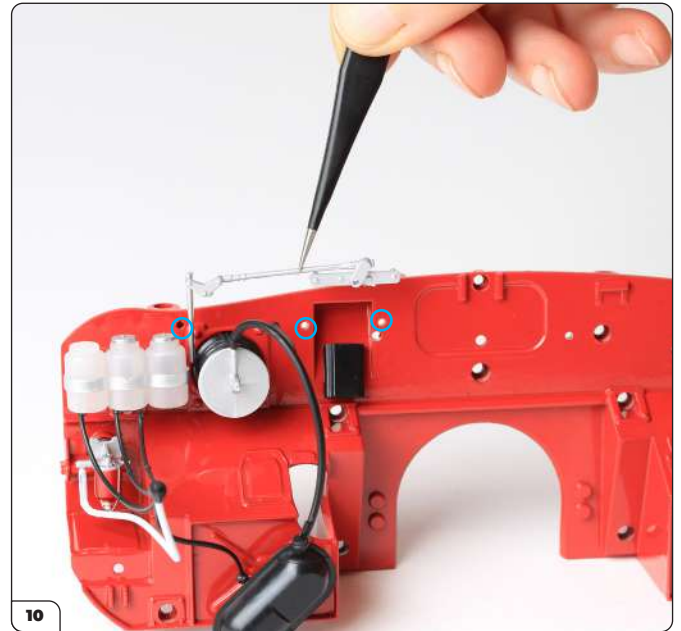

Line up the tiny pins on the throttle linkage with the corresponding holes on the bulkhead (circled).



Press the linkage into place.

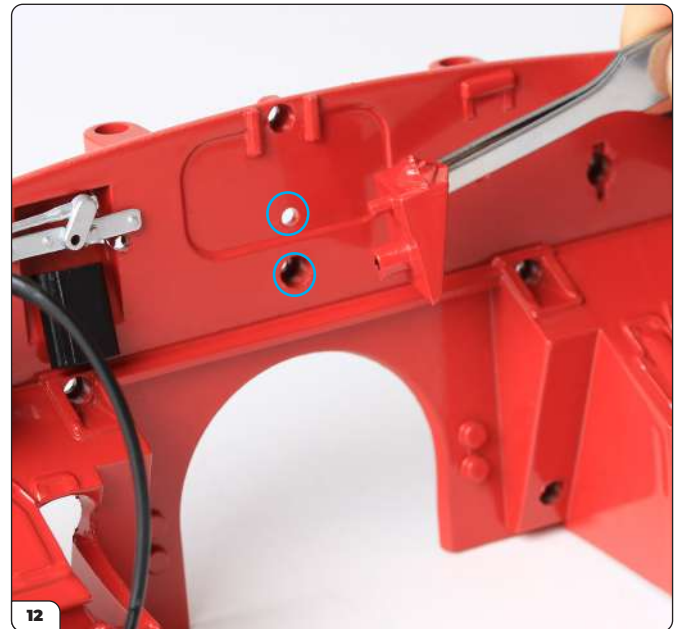

Align the two pins on the engine stabiliser mounting with the two holes on the bulkhead (circled).

Stage 36: Bulkhead Fittings



Press the mounting into place.

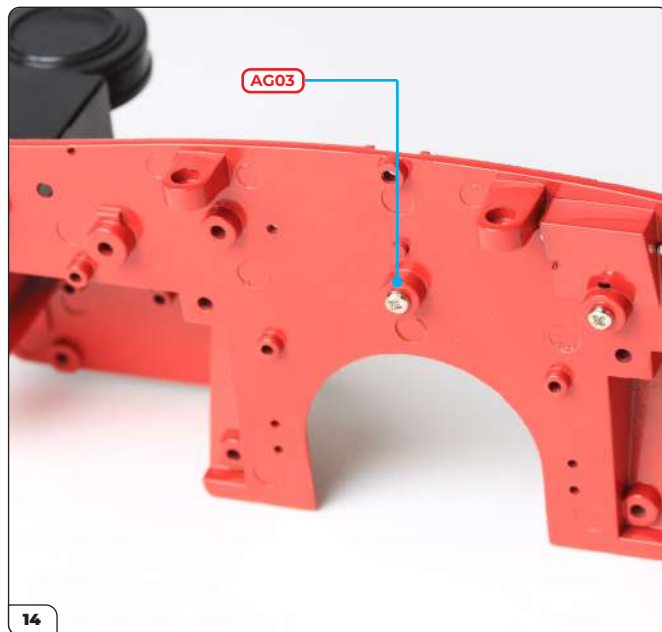

Secure from the reverse side with an AG03 screw.



To assemble the washer reservoir, align the keyhole-shaped lug on the cap with the top of the reservoir.



Press the cap into place.

Stage 36: Bulkhead Fittings

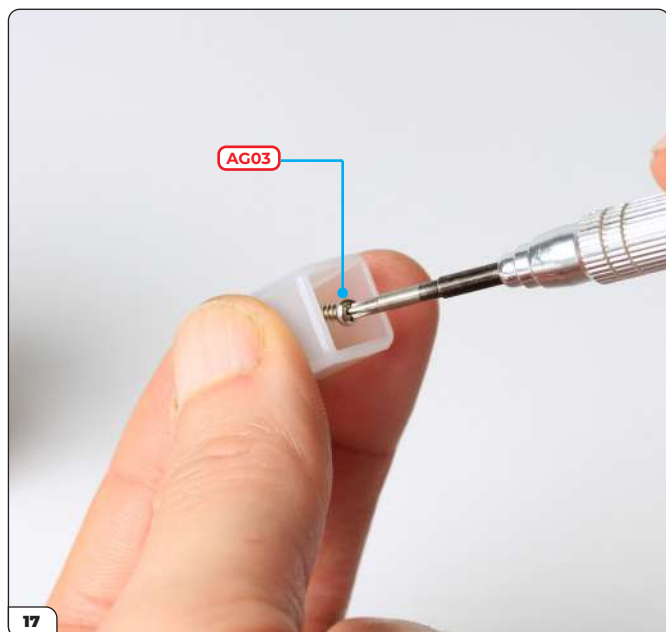

Secure the cap from the underside using an AG03 screw.

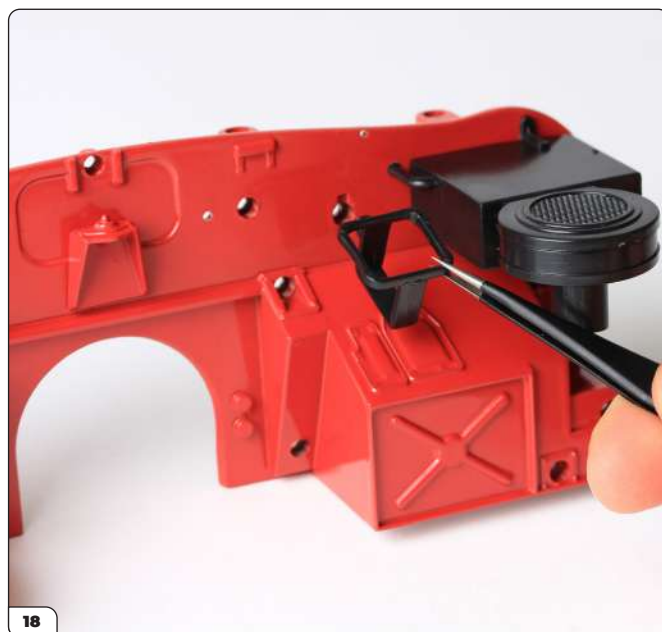

Take the reservoir bracket and line it up with the keyhole-shaped hole on the bulkhead.



Push into position...

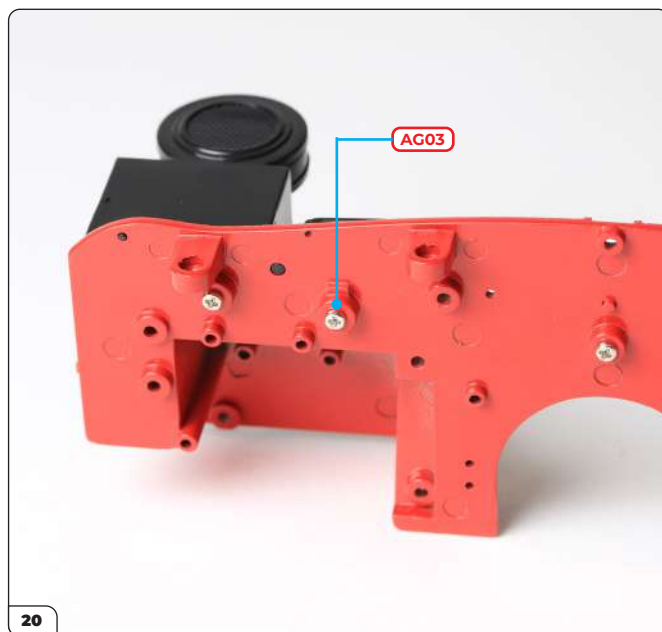

... and secure in place using an AG03 screw.

Stage 36: Bulkhead Fittings



Sit the reservoir in the bracket with the tiny hole in the cap facing outwards (inset).



Line up the heater water control valve next to the reservoir.

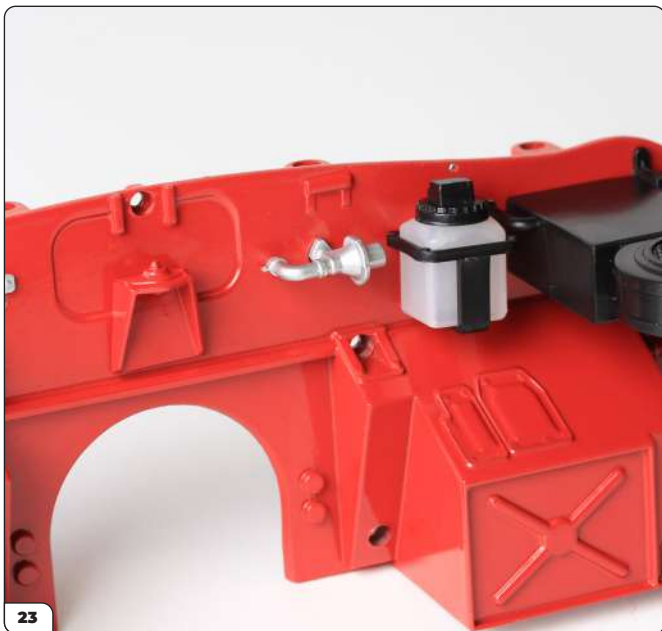

Press firmly into position.

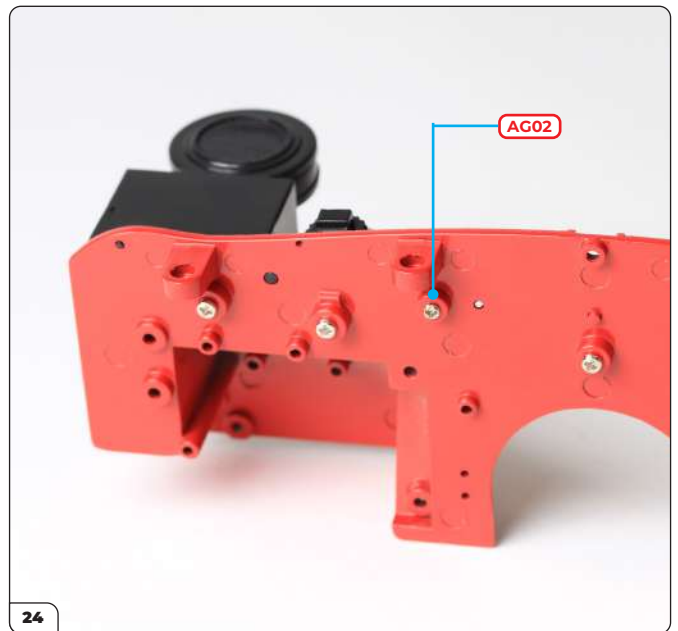

Secure from the reverse side using an AG02 screw.

Stage 36: Bulkhead Fittings

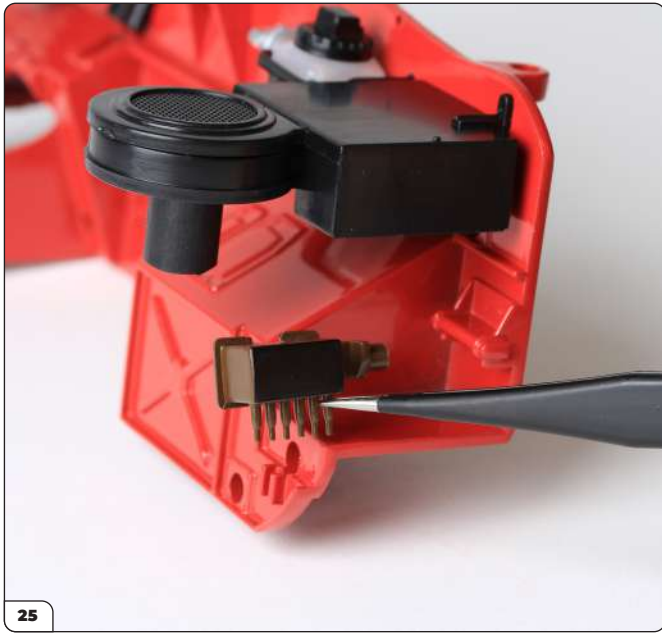

The voltage control unit is fitted below the heater case.



Push the lug into the bulkhead as shown.

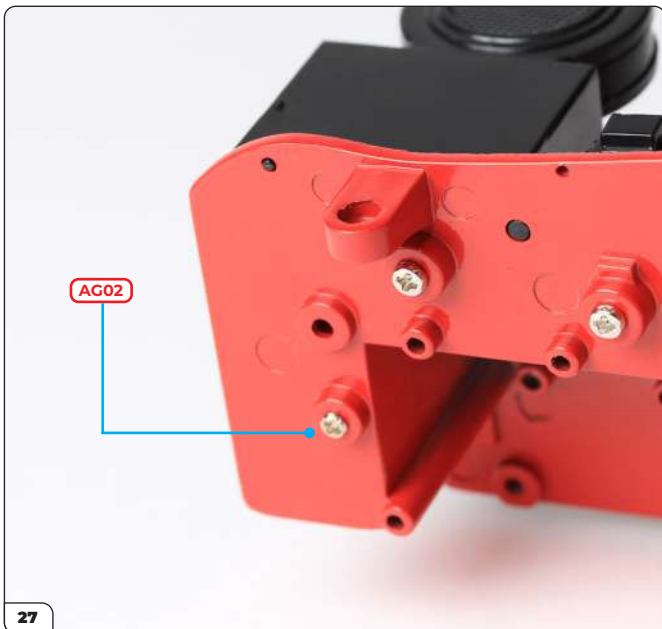

Secure from the reverse side with AG02 screw.

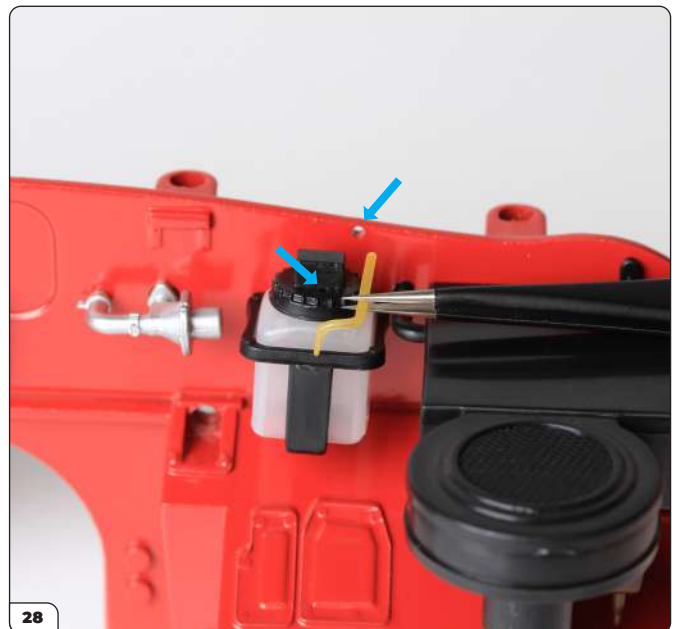

Fit one end of the washer tube into washer reservoir cap and the other end into the bulkhead as shown (see step 29).

Stage 36: Bulkhead Fittings

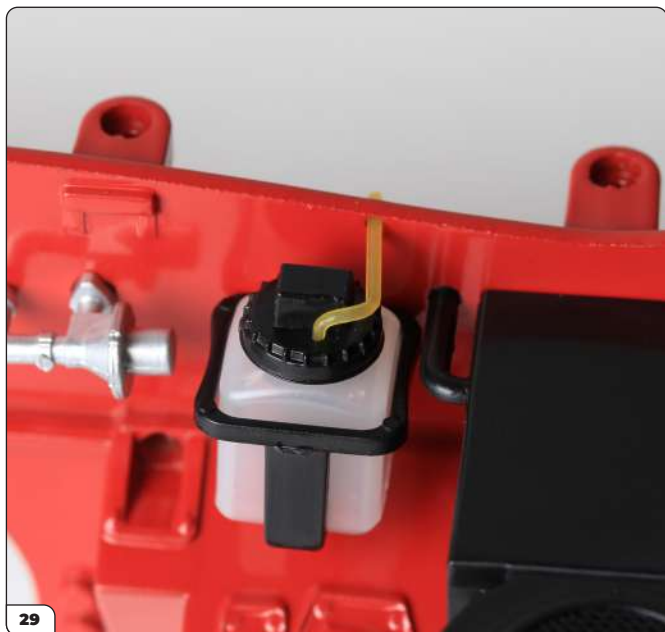

The washer tube is fitted into place.

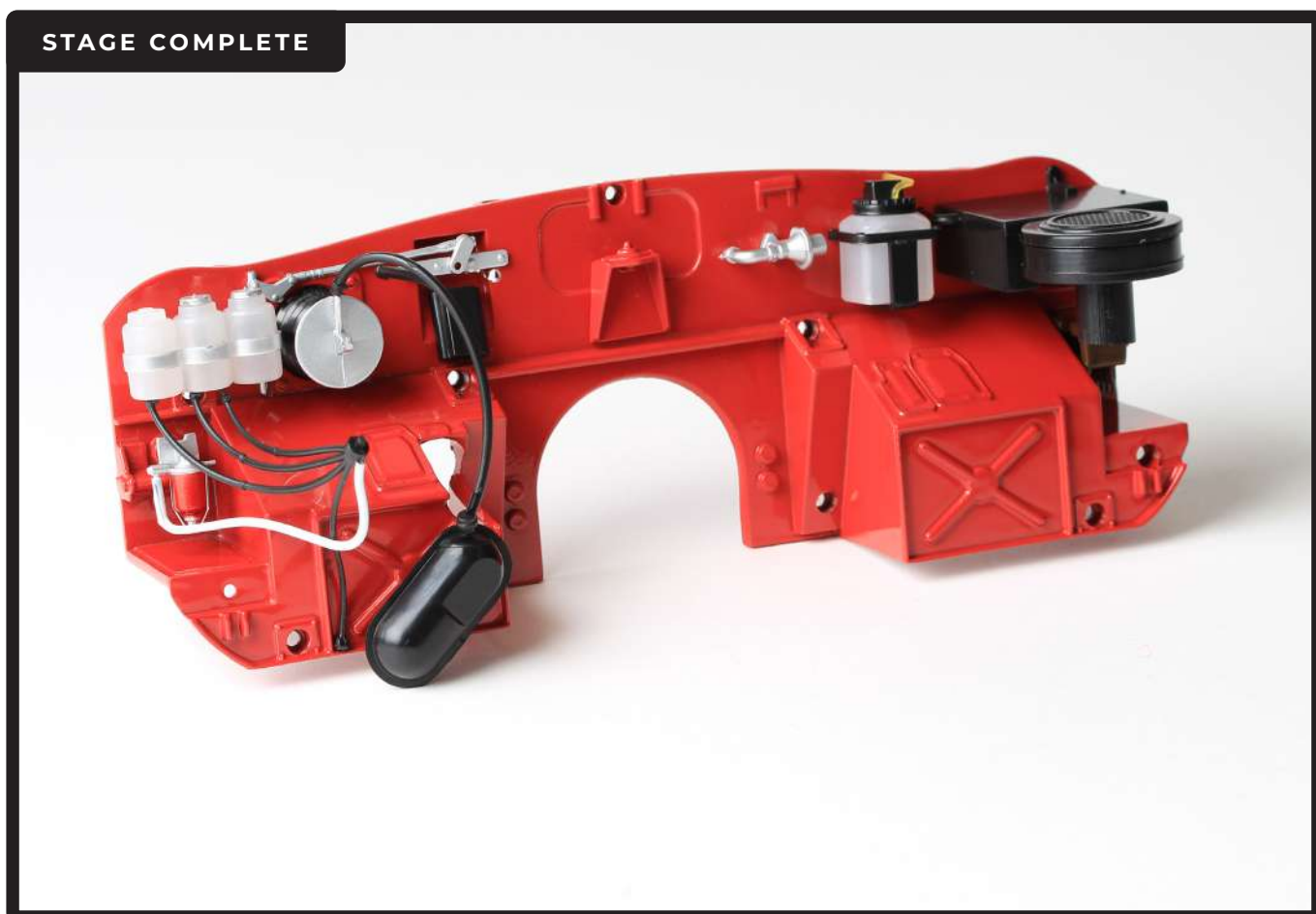

Stage 37: Engine Bay Fittings

In this next stage, you'll continue to connect the pipes and hoses, fix the engine and subframe to the bulkhead, install the battery, and add the mudshields.



STAGE 37 PARTS LIST

Name
Left-hand mudshield
Right-hand mudshield
Battery
Gearbox mountings x2
Battery leads
Screws type AG02 x2
Screws type AM18 x5
Screws type AM15 x9
Screws type AG03 x8



Stage 37: Engine Bay Fittings

STEP 1

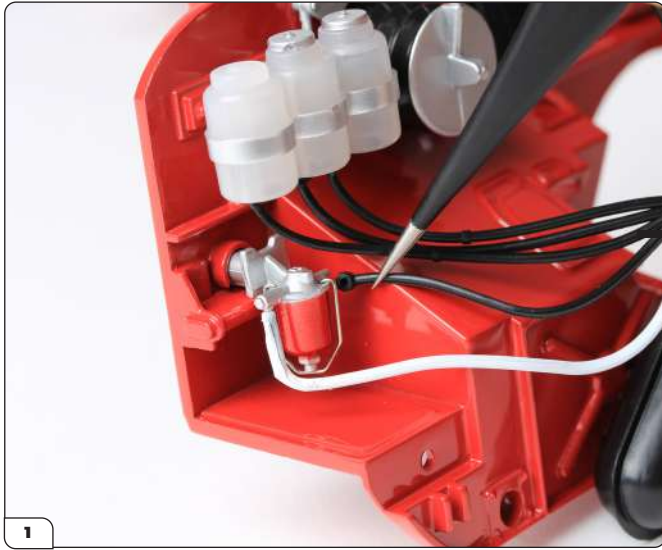

Plug the remaining black pipe from the bunch into the pin on the inner side of the fuel filter.

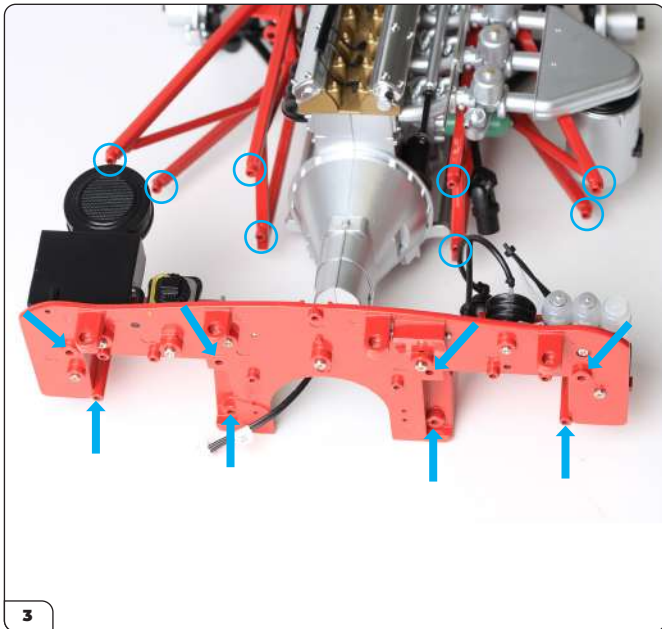

Now the bulkhead can be fitted to the subframe. Start by aligning the engine and subframe assembly with the bulkhead as shown. Note there are eight fixing points (circles and arrows). Bring the two assemblies together, matching up the fixing points.

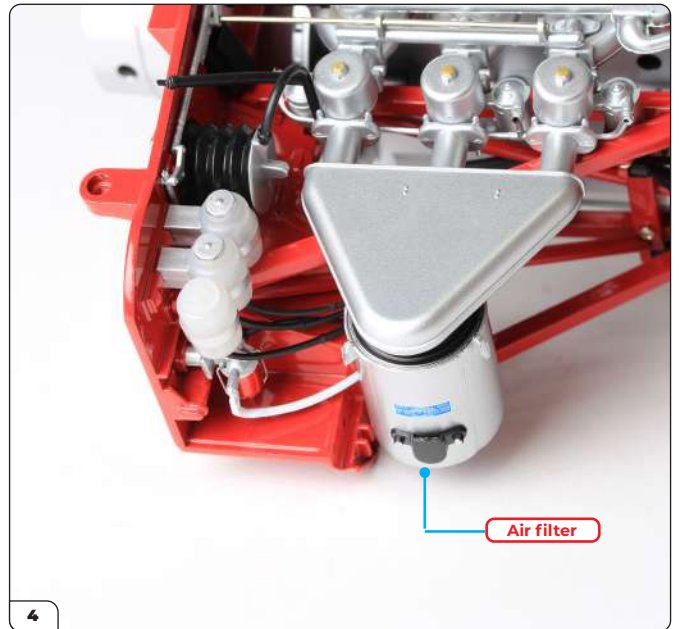

Before fixing anything, check that the bunch of black pipes are not trapped under the frame and that they are free to be moved behind the air filter. See step 16 for more guidance.

Stage 37: Engine Bay Fittings

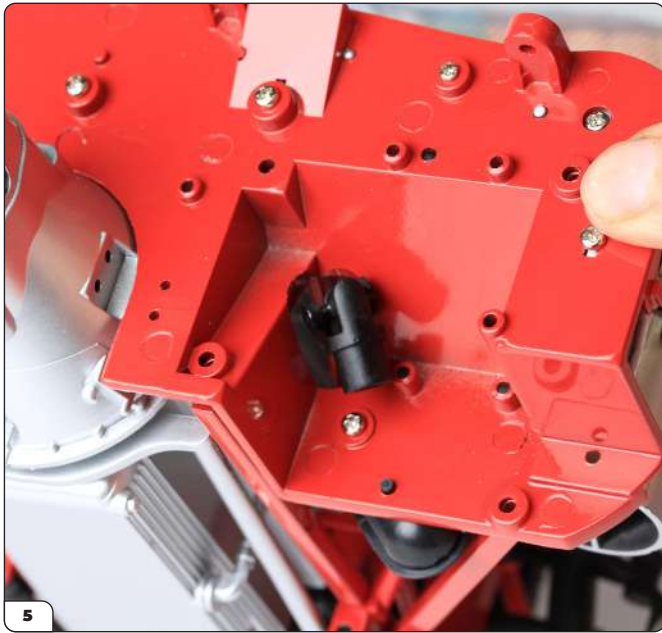

The steering column fits through the opening in the bulkhead.



Use tweezers to fit the end of the throttle rod into the hole in the throttle linkage, and fit the end of the water hose into the hole in the bulkhead.

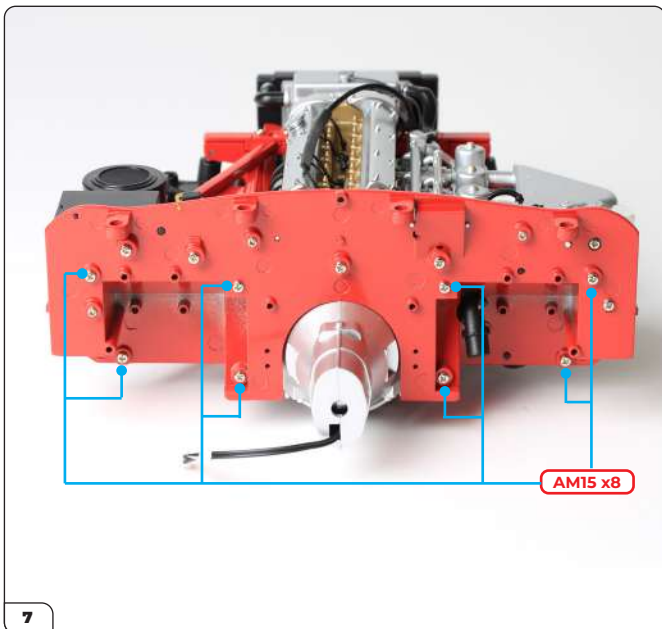

When you have checked that everything is in the correct place, fix the subframe to the bulkhead using 8 x AM15 screws.



Next, you'll install the battery. Start by plugging the battery leads into the battery by positioning them as shown.

Stage 37: Engine Bay Fittings



Push the two battery connections firmly into the holes in the top of the battery.



Align the battery with the left-hand mudshield as shown.



Push the lug on the bottom of the battery into the hole in the mudshield.

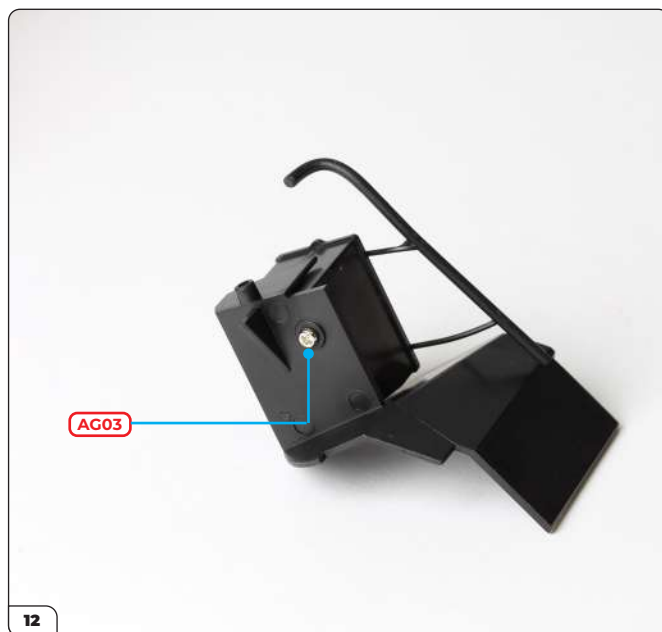

Fix the battery in place using an AG03 screw.

Stage 37: Engine Bay Fittings

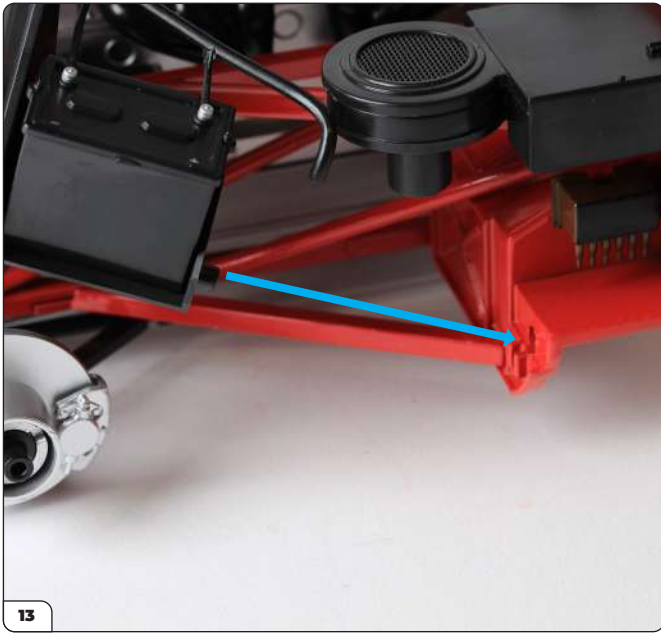

Position the assembly on the subframe, just below the heater motor.

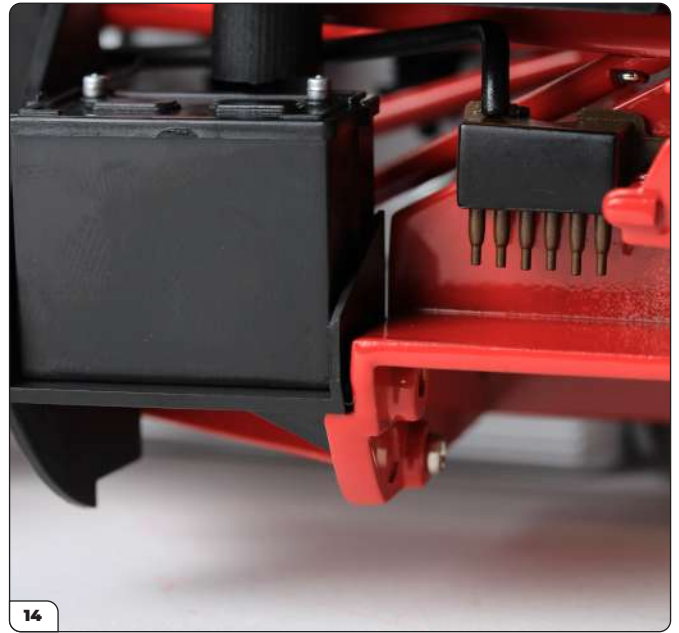

Fit the lug on the end of the mudshield into the hole on the subframe.

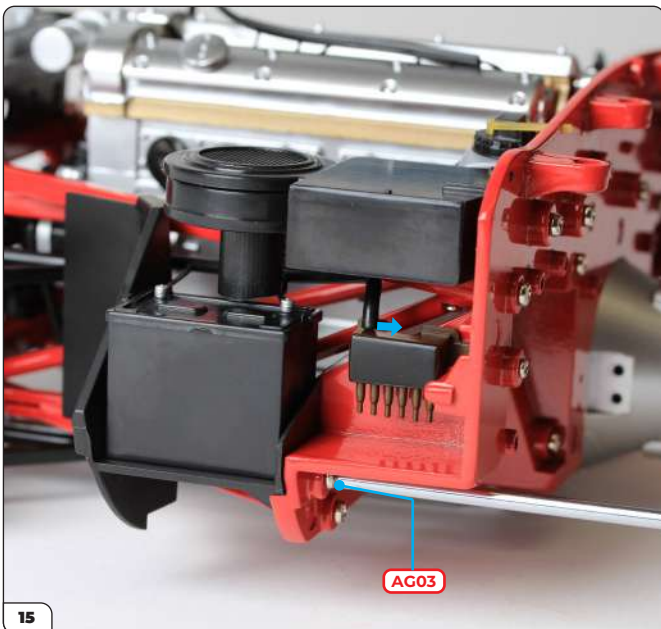

Fix the mudshield in place using an AG03 screw. Make sure the end of the battery cable sits in the hole in the voltage control unit (arrow).

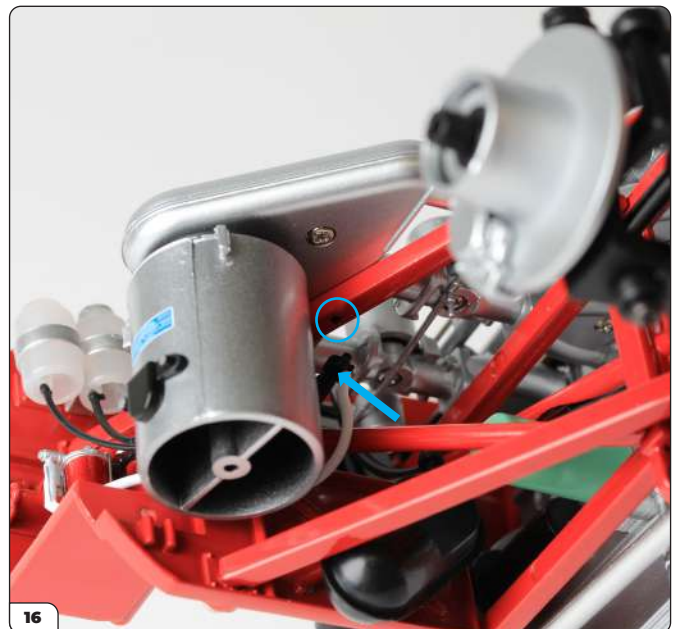

The end of the bunch of pipes, carefully positioned in step 4, can now be fixed in place. Using tweezers, grip the end of the bunch behind the pin (arrow) and push the pin into the hole in the subframe (circled).

Stage 37: Engine Bay Fittings

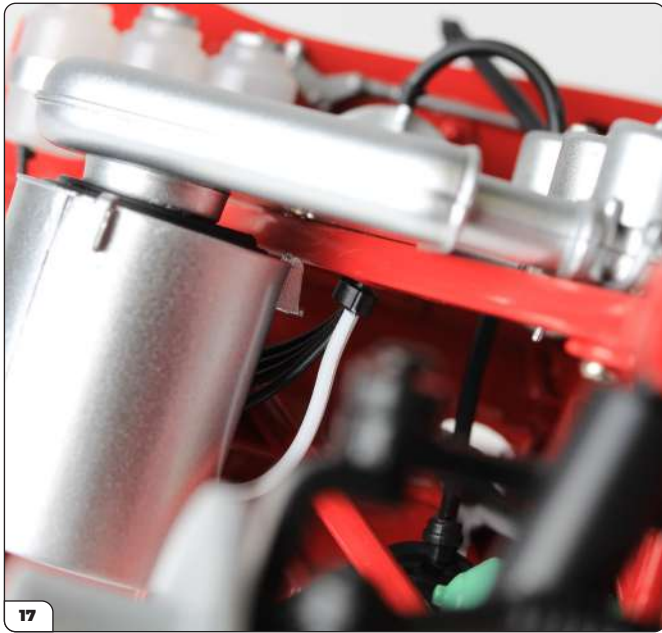

Push the pin firmly into the subframe.



Fit the remaining black pipe from the brake vacuum hoses (stage 35, step 21) by gripping it with tweezers and pushing the pin on its end into the hole in the end of the air balance pipe. All the pipes can be secured with a tiny drop of superglue if required.

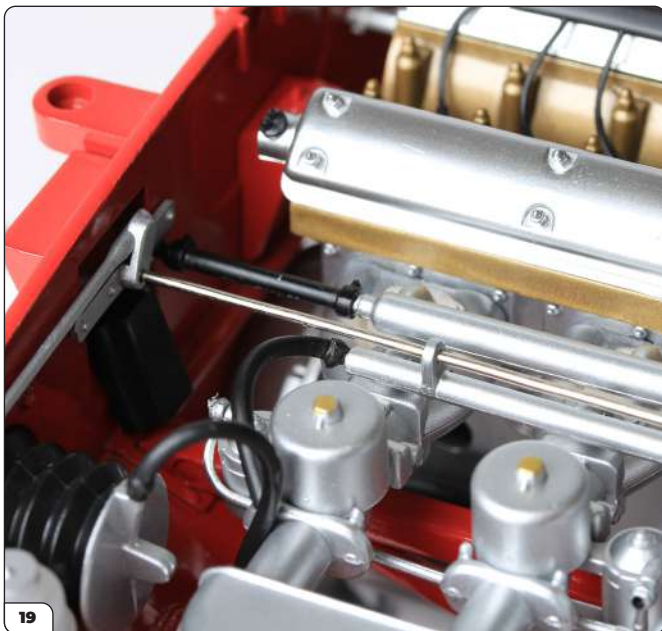

The brake vacuum hoses have now be fitted.



Take the right-hand mudshield and position it in front of the air filter.

Stage 37: Engine Bay Fittings



Slide the mudshield under the air filter...

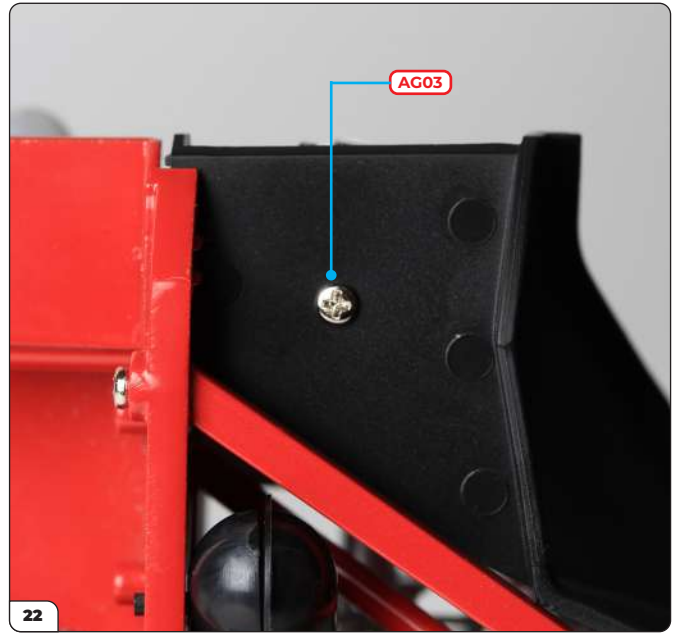

... and secure in place from the underside using an AG03 screw.

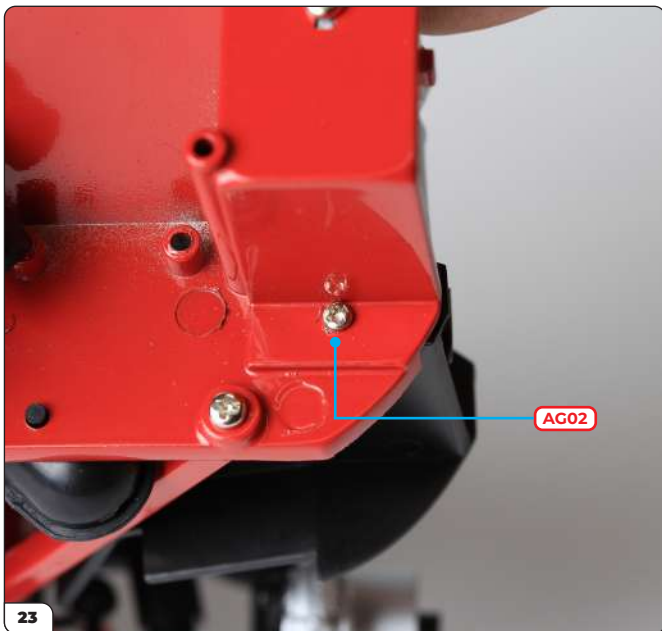

Then secure the mudshield to the bulkhead with an AG02 screw.

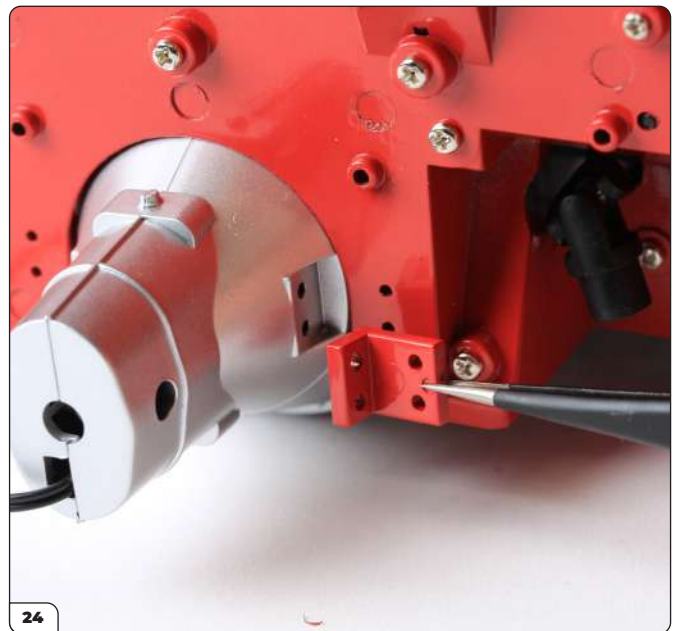

Take one of the gearbox mountings and fit it into the recess at the back of the gearbox.

Stage 37: Engine Bay Fittings

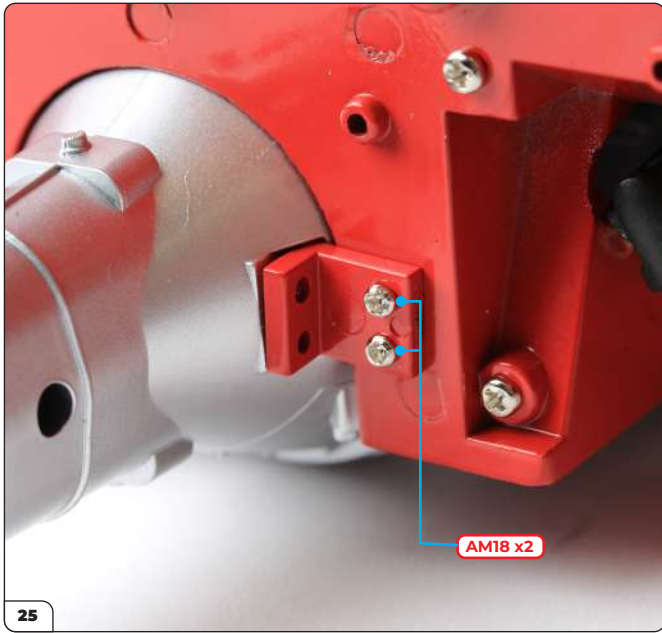

Screw the mounting to the bulkhead using 2 x AM18 screws.

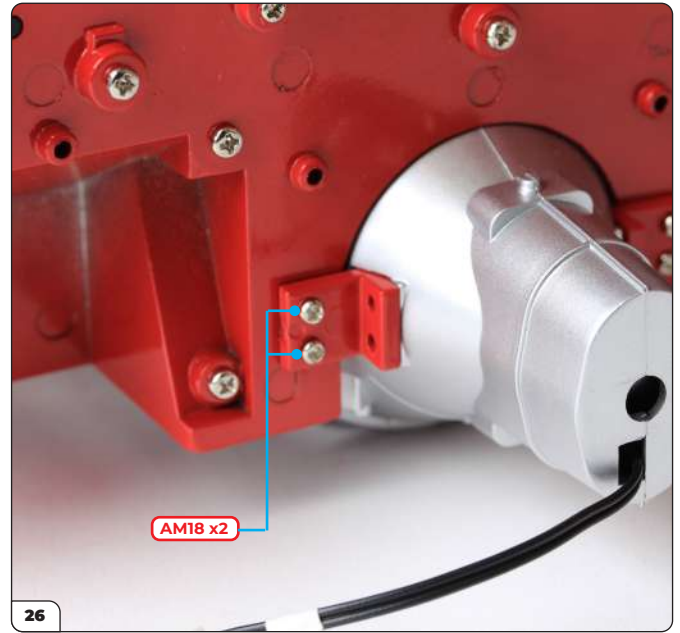

Repeat on the other side to fix a second mounting to the bulkhead.

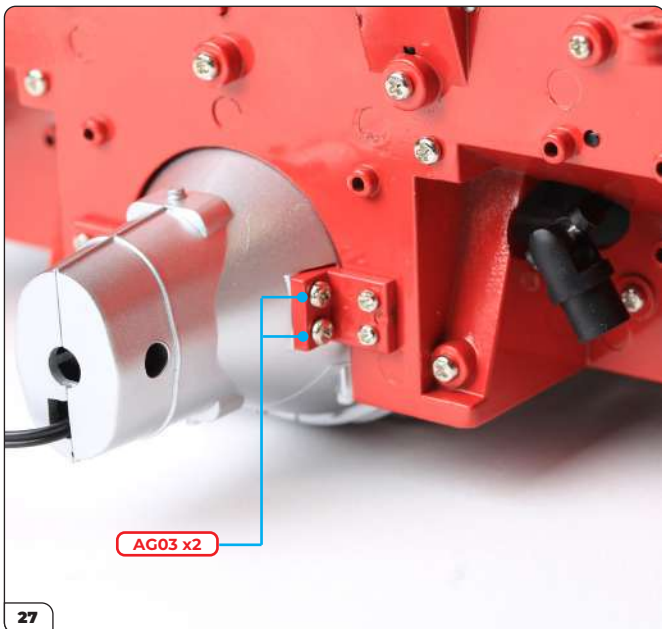

Using 2 x AG03 screws this time, fix the mounting to the gearbox on one side...

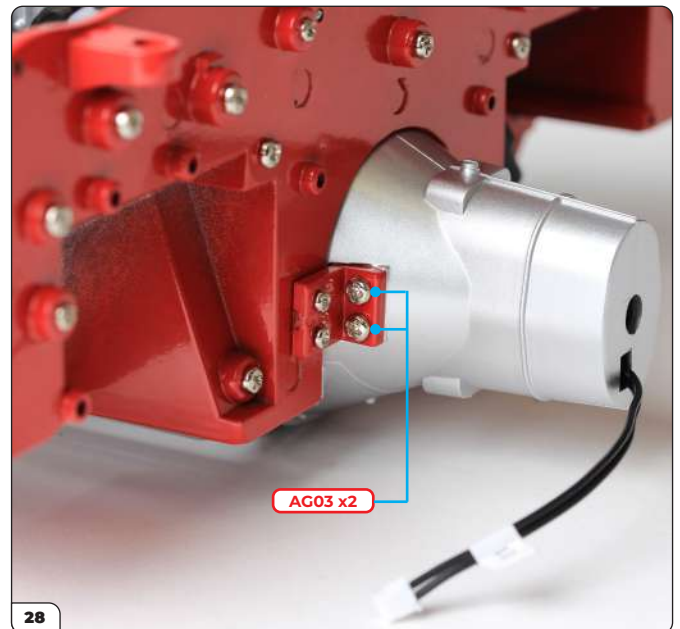

... and repeat on the other side.

Stage 37: Engine Bay Fittings

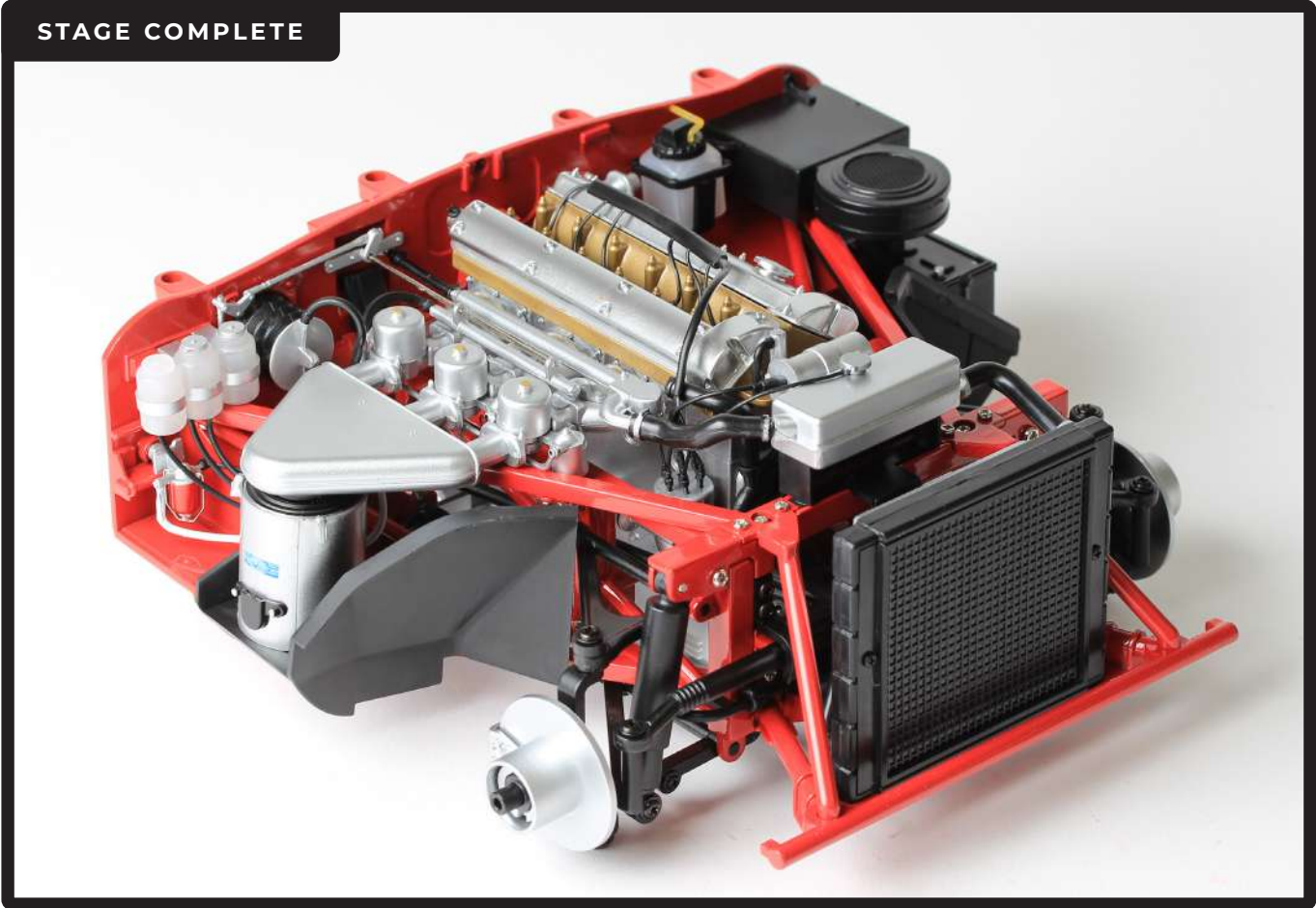

Stage 38: Right Front Wheel

Pack 5 is completed by building your second wheel. Unpack the parts in this stage and move on to stage 39 to start lacing the spokes.



STAGE 38 PARTS LIST

Name
Wheel rim (outer)
Inner spokes x24



Wheel rim (outer)



Inner spokes x24

Stage 39: Right Front Wheel

The process for assembling this second wheel is exactly the same as for your first wheel. Don't forget, the trick is to adjust the tension on the spokes by gently pressing and twisting the wheel centre. Also check you have the spokes hooked around the wide tooth on the spoke retainer when instructed.



STAGE 39 PARTS LIST

Name
Wheel centre
Spoke retainer ring
Inner spokes x24
Screws TYPE AG02 x5

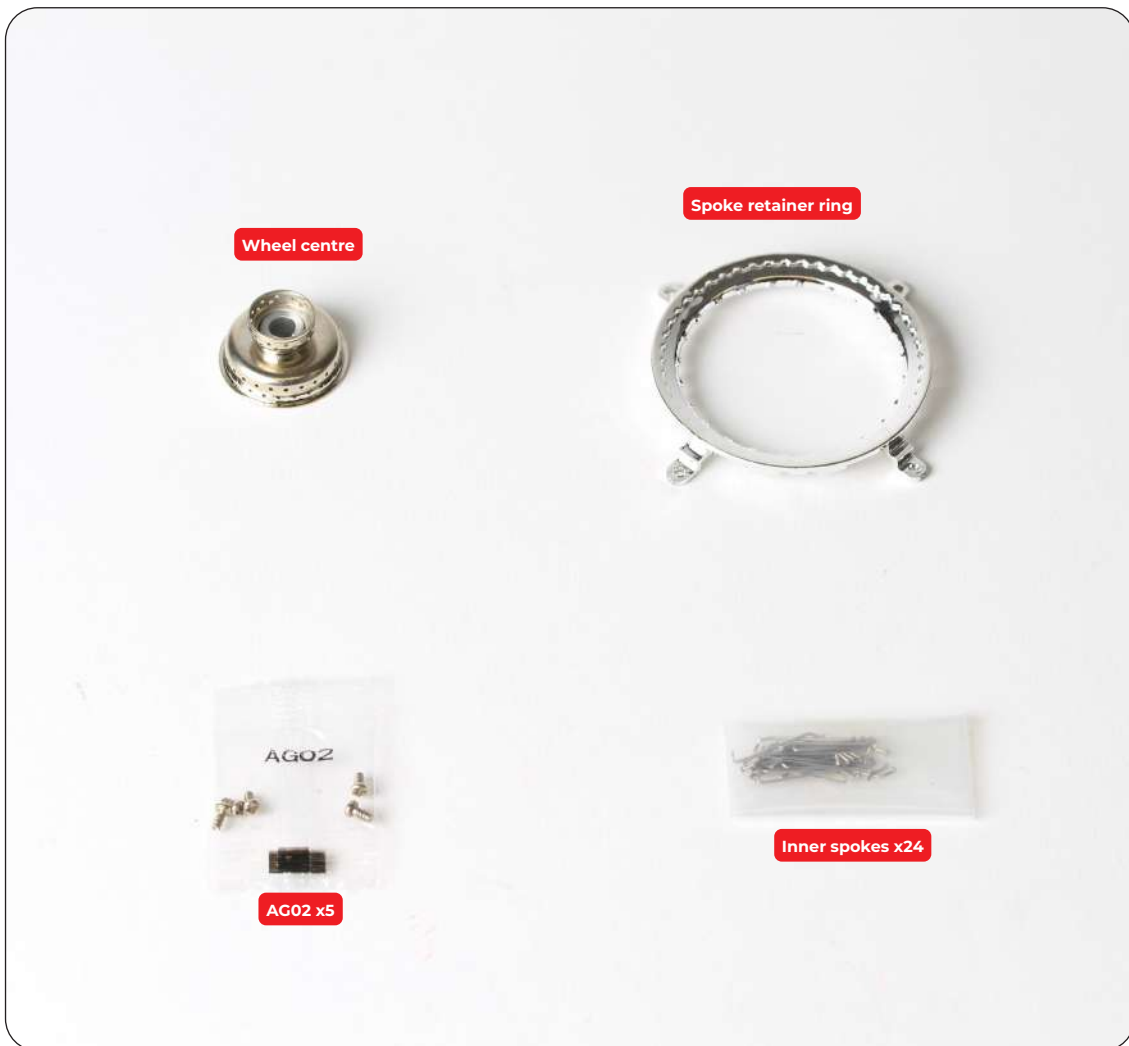

Stage 39: Right Front Wheel

STEP 1

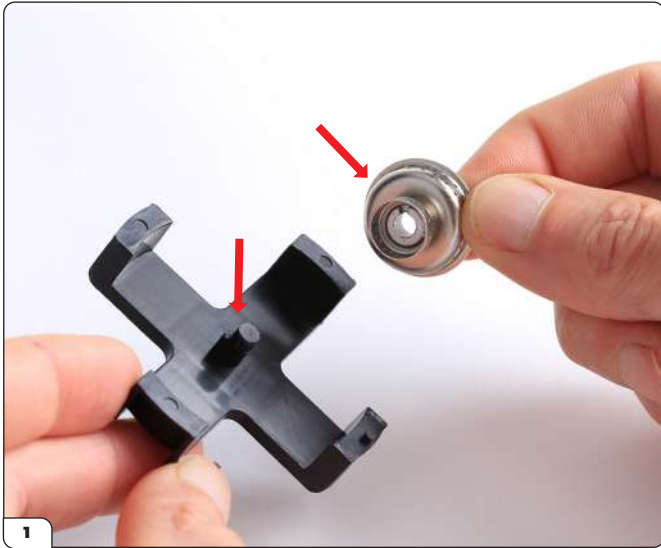

Take the wheel centre and note that there is a small notch that aligns with a corresponding tab on the jig (arrows). The jig is used here to assist with building the wheel and will be removed towards the end of the wheel-build.



Fit the wheel centre onto the jig.

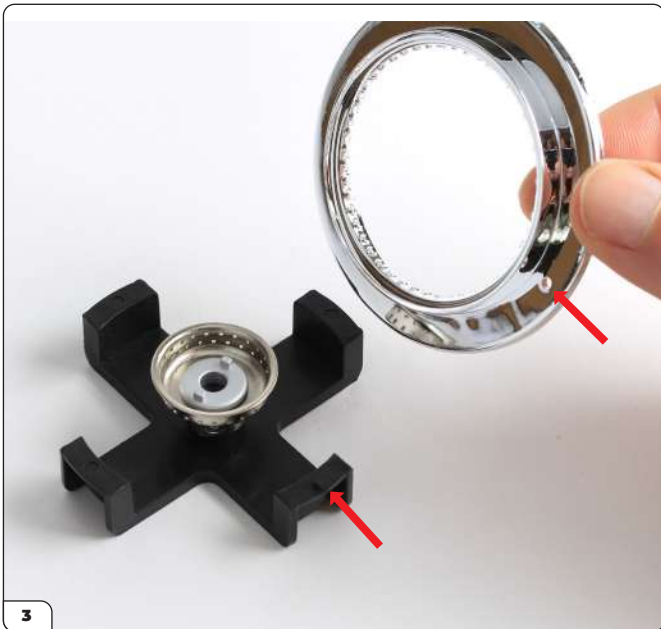

Take the wheel rim from stage 38 and align the hole on the outer edge with the pin on the jig (arrows).



Fit the wheel rim onto the jig, pressing firmly to lock the rim into position.

Stage 39: Right Front Wheel

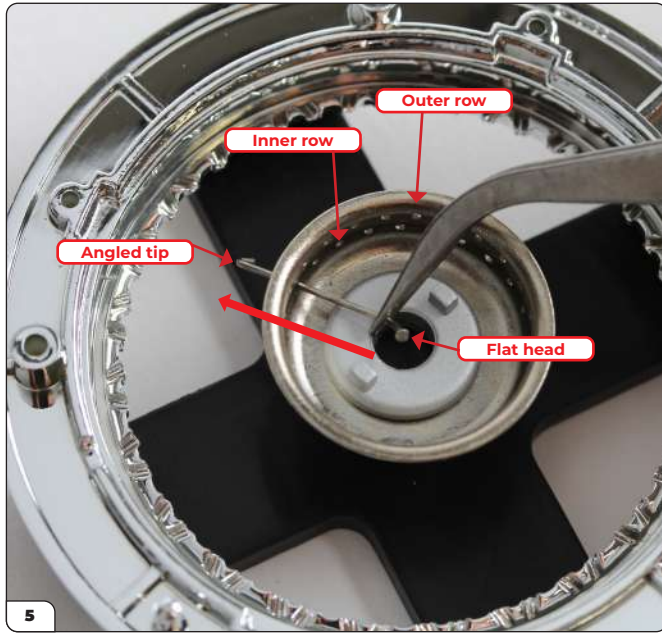

Before you begin, note that the inner edge of the spoke retainer ring has a series of 'teeth', alternating in size (see picture 6). Each spoke has a right-angled tip, and a flat head on the opposite end. Use your tweezers to thread the spokes and hook them into place. Start by threading a spoke, leading with the tip, through a hole in the innermost row of holes in the wheel centre. (Note: The spokes in stages 38 & 39 are the same.)

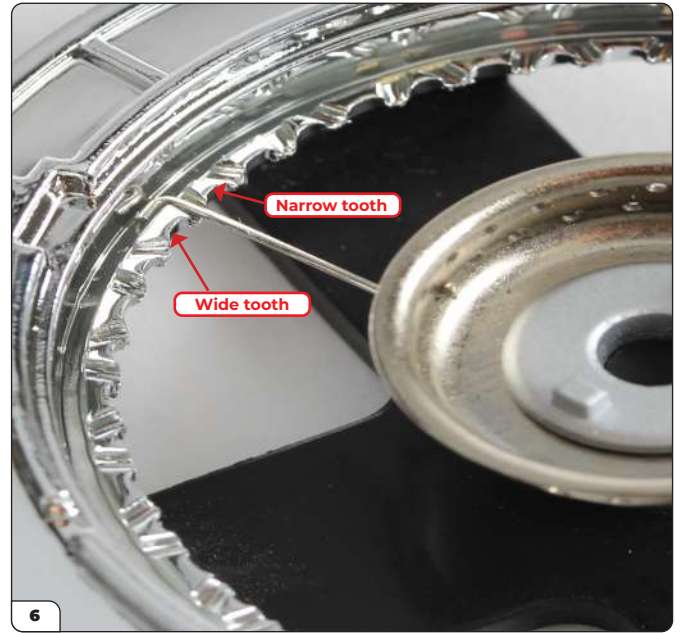

Pull the spoke through the hole and hook the tip around the nearest 'wide' tooth that gives the spoke a comfortable fit.

NOTE: The key to fitting the spokes correctly is to adjust the tension on each spoke as you fit it by gently pushing and/or twisting the wheel centre with your thumb.



Then take another spoke and thread it through the next hole in the innermost row of the wheel centre. Pull the spoke through the hole and hook the tip around the next 'wide' tooth.



Fit the third spoke in the same way, and continue all the way around the wheel until you have filled all the holes on the inner row of the wheel centre. Check that they are hooked around the **wide teeth**. If they are not hooked around wide teeth, the spokes will not fit and the wheel parts will not fit together at the end of the build.

Stage 39: Right Front Wheel



This is how your wheel should look after fitting the first row of spokes.



Check that all the spokes have been fitted to the innermost row of the wheel centre. Next, you will fit spokes to the uppermost row.



Start in the same way, threading the tip of a spoke through a hole in the uppermost row.



The spoke tips will now face in the opposite direction to those fitted on the bottom row. Make sure that they are hooked around a 'wide' tooth otherwise they cannot be secured in place in a later step.

Stage 39: Right Front Wheel



Repeat steps 11 & 12 to fit the second spoke in a hole adjacent to the first spoke on the upper row.



Continue to fit all the spokes in the same way, all the way round the upper row, ensuring that they hook around a **wide tooth**.



The second row of spokes has been fitted.

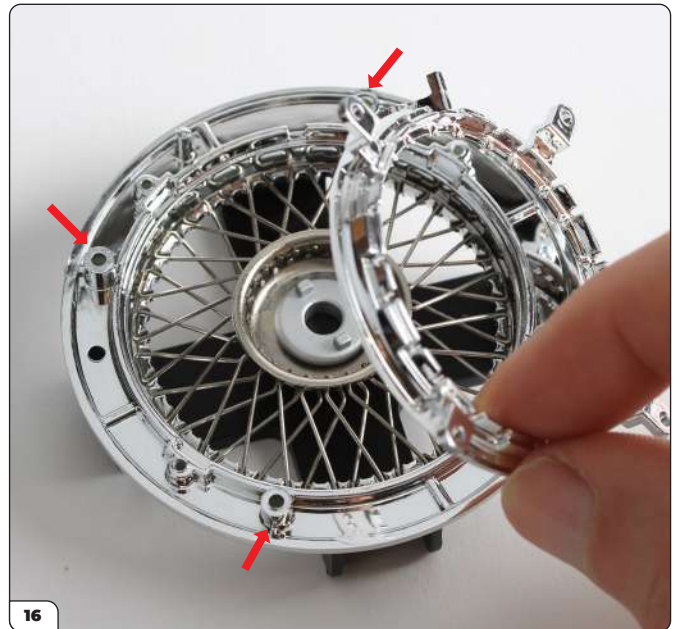

Prepare 4 x AG02 screws and have your screwdriver ready. Carefully align the spoke retainer ring over the wheel. The projecting screw holes on the ring will fit onto the raised screw holes as indicated. Lower the ring into position.
Note: the projecting pin on the spoke retina locates in the notching wheel rim.

Stage 39: Right Front Wheel



Hold the retainer in position so that the spokes are secured as you fit an AG02 screw.



Keep holding everything together as you fit the remaining 3 x AG02 screws.



All four screws have been fitted and the spokes are now held securely in place.

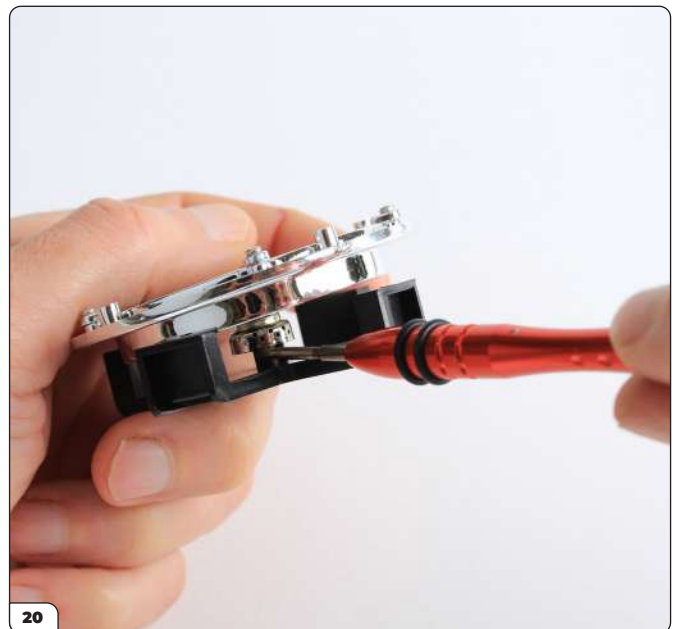

Gently prise the wheel off the jig. Do not pull the wheel – try to carefully release it using a screwdriver or similar tool that will act as a lever.

Keep the jig as you'll need it to assemble the remaining wheels.

Stage 39: Right Front Wheel

STAGE COMPLETE



Stage 40: Right Front Wheel

Continue to lace the spokes to create a beautiful work of art. The tyre will be supplied in stage 41 in your next pack.



STAGE 40 PARTS LIST

Name
Spacer ring
Wheel rim
Spokes type B x12
Spokes type A x12
Screws TYPE AG03 x5

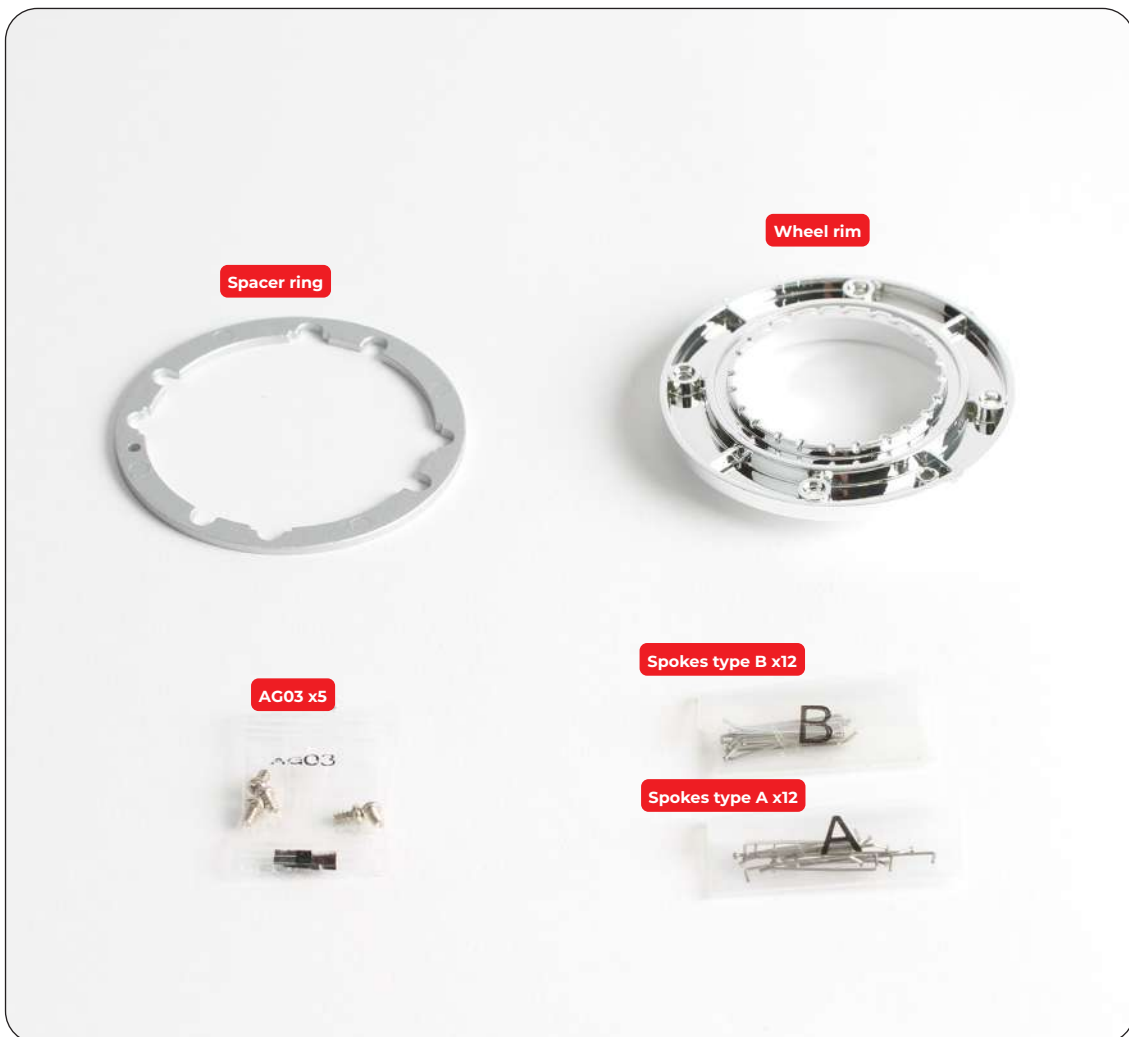

Stage 40: Right Front Wheel

STEP 1

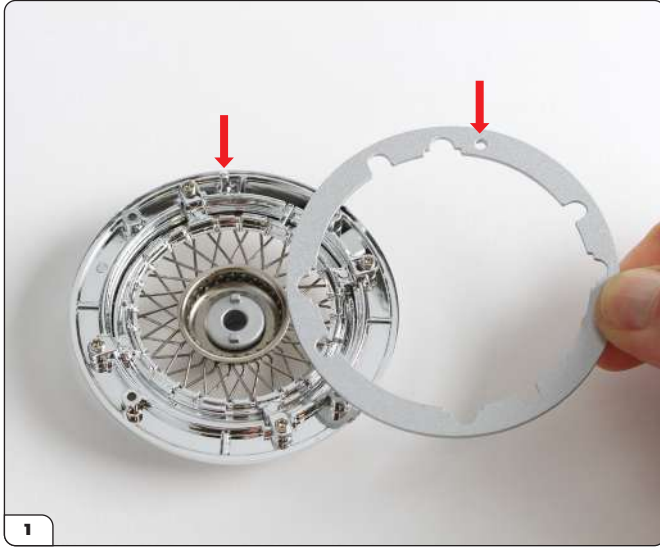

Take the spacer ring and align it over the wheel from Stage 37. There is a hole on the ring with a corresponding peg on the wheel (arrows) to ensure the correct fit.



Lower the ring onto the wheel and press firmly until it clicks into place.



Turn the wheel over so that the smaller side of the wheel centre is facing you. Note that there are two rows for threading the spokes – an inner row and an outer row. You're going to start on the inner row.



Using tweezers, thread a type A spoke through a hole on the **inner row**. Direct the tip of the spoke through the diamond-shaped opening slightly clockwise (coloured red above) so that the tip pokes through to the opposite side.

Stage 40: Right Front Wheel

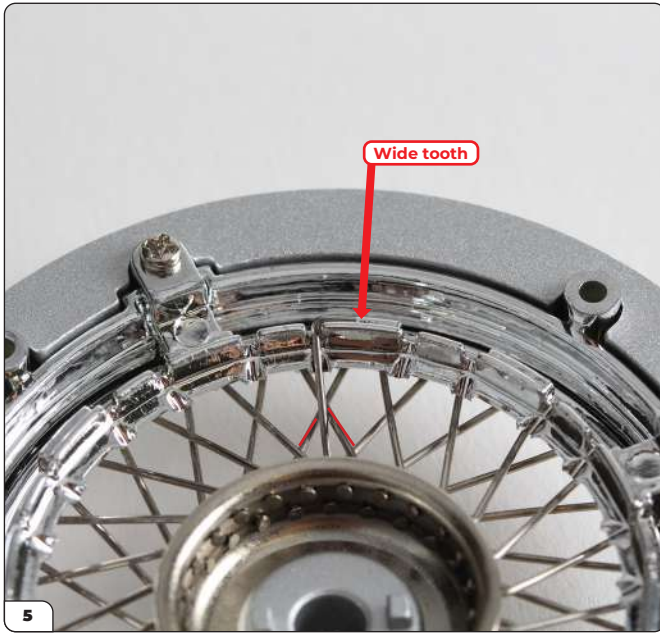

Turn the wheel over and check that the tip will hook onto a **wide** tooth on the opposite side. If it doesn't fit a wide tooth, start again, threading the spoke through the next diamond-shaped hole along.



Once you are happy that the first spoke is fitted correctly, thread the next spoke through an adjacent hole in the lower row, but this time, poke it through the diamond-shaped hole that is two-along.



Continue to thread the type A spokes all the way around the inner row, pushing the tip through alternate diamond-shaped openings as indicated.



All 12 x type A spokes have been fitted to the inner row.

Stage 40: Right Front Wheel

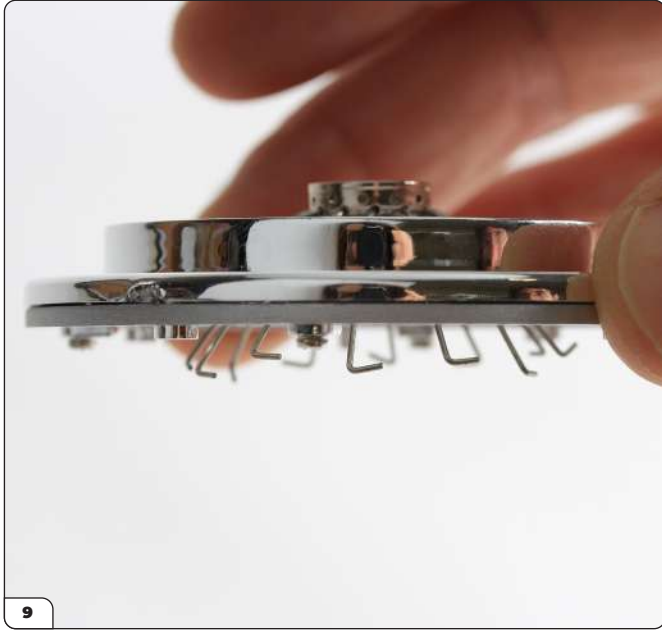

The 12 spokes should poke out on the opposite side of the wheel like this. Leave them all loose for now.



Fit the type B spokes to the outer row of the wheel centre, just above the type A spokes.

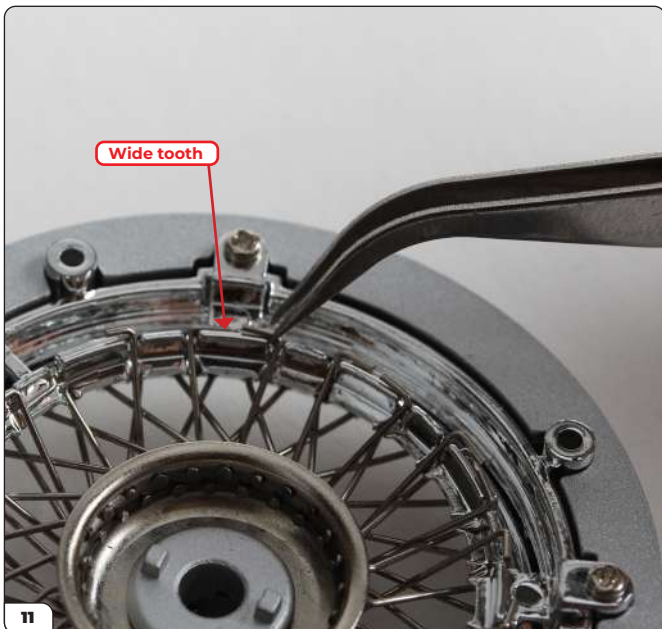

When you fit the first type B spoke, thread it through an empty diamond-shaped opening (see step 12) and check that it will hook around a **wide** tooth on the opposite side as shown here.

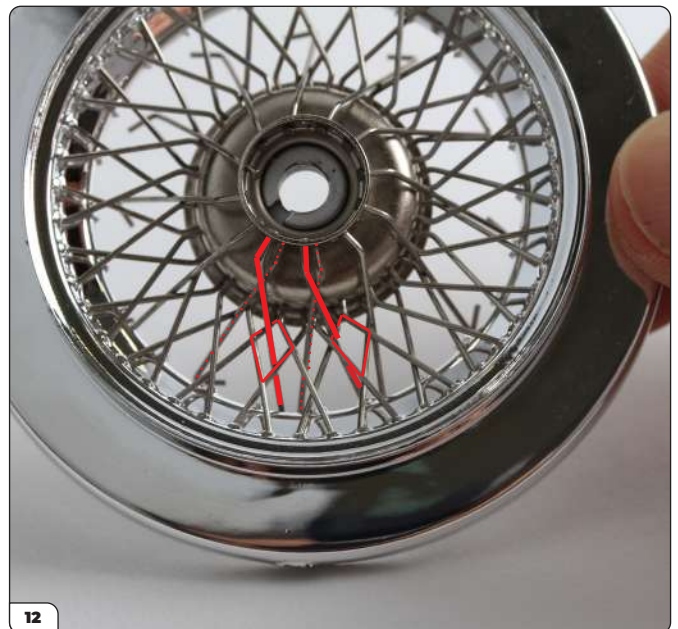

When you thread the type B spoke through to the opposite side, it should cross a type A spoke and fit through an empty diamond-shaped opening. It should lead slightly anti-clockwise. Check that it will hook a wide tooth, but do not hook it just yet, leave the spokes loose.

Stage 40: Right Front Wheel



All 12 x type B spokes have been fitted to the outer row of the wheel centre and are left loose on the underside.



Use a piece of cotton wool or kitchen paper to hold the pin ends of the spokes in place in the inner and outer rows of the wheel centre.

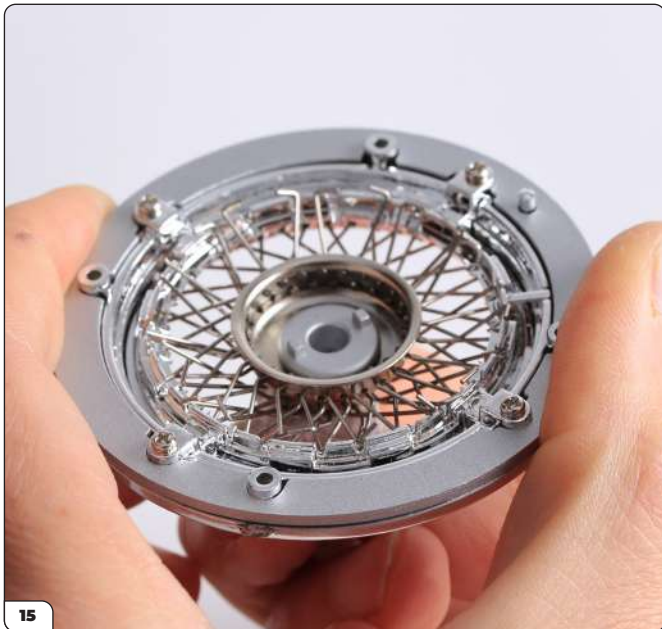

Keep holding the cotton wool firmly as you turn the wheel over.

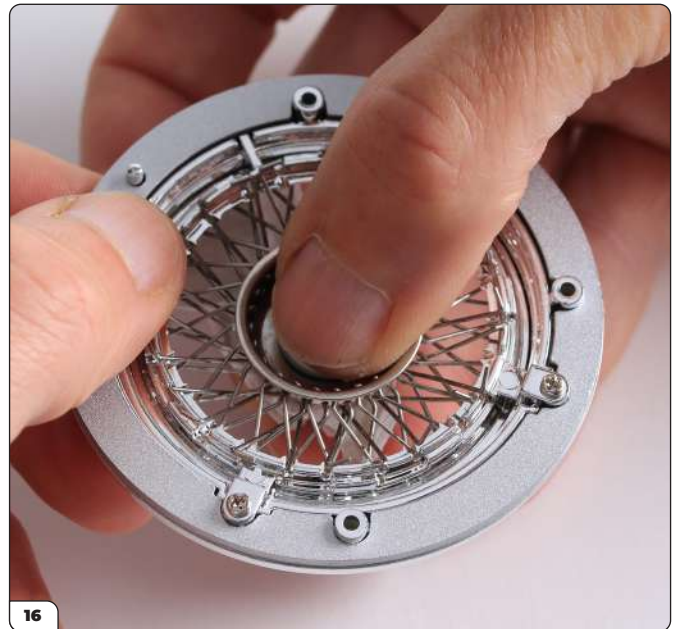

Keep holding the wheel centre firmly, as you gently hook the ends of spokes A and B around the teeth. Use your thumb in a stroking motion, or tweezers here. The fit of the spokes can be lightly adjusted by gently pressing and/or twisting the wheel centre with your thumb.

Stage 40: Right Front Wheel



Spokes A and B are correctly hooked in place around the teeth.



Take the inner wheel rim and align the four screw holes and the pin (arrowed). Prepare 4 x AG03 screws and a screwdriver.



Press the inner wheel rim into place. Check that the gap between the spoke retainer ring and the inner rim has closed up. If not, remove the inner rim and recheck the position of the spokes, Step 17.



Fix the inner wheel rim in place with 4 x AG03 screws.

Stage 40: Right Front Wheel

STAGE COMPLETE

