



# FERRARI

# 312 T4

THE LEGENDARY 1970s F1 FERRARI

PACK **06**

STAGES 43-52



SCALE  
**1:8**

**AGORA**  
MODELS®



# FERRARI

# 312 T4

SCALE  
1:8

## Contents

<b>STAGE 43</b>	
BRAKE AIR INTAKE.....	1
<b>STAGE 44</b>	
WISHBONE ARMS .....	5
<b>STAGE 45</b>	
PARTS TO SECURE SUSPENSION TO CHASSIS.....	9
<b>STAGE 46</b>	
LEFT SUSPENSION JOINTS AND WISHBONE ARMS .....	13
<b>STAGE 47</b>	
BRAKE LINE FITTINGS AND FIRST STEERING PARTS .....	17
<b>STAGE 48</b>	
LEFT AND RIGHT SIDES OF BODYWORK....	21
<b>STAGE 49</b>	
CROSS WRENCH AND DRAG LINK PLATES.....	25
<b>STAGE 50</b>	
LEFT HAND RADIATOR PARTS .....	29
<b>STAGE 51</b>	
RIGHT HAND RADIATOR PARTS .....	33
<b>STAGE 52</b>	
COOLANT FLUID TANK.....	37

© Agora Models

**AGORA**  
MODELS.

WARNING: NOT SUITABLE FOR CHILDREN UNDER THE AGE OF 14. THIS PRODUCT IS NOT A TOY AND IS NOT DESIGNED OR INTENDED FOR USE IN PLAY. ITEMS MAY VARY FROM THOSE SHOWN.

Produced under license of Ferrari S.p.A. The name FERRARI, the PRANCING HORSE device, all associated logos and distinctive designs are property of FERRARI S.p.A. The body designs of the Ferrari cars are protected as Ferrari S.p.A. property under design, trademark and trade dress regulations.

# BRAKE AIR INTAKE

WITH THE PARTS INCLUDED IN THIS STAGE, YOU CAN CONTINUE BUILDING THE SECOND FRONT WHEEL BRAKE.



## LIST OF PARTS

- 1 Air intake (outer)
- 2 Hubcap
- 3 Air duct (inner)
- 4 Brake disc support





01

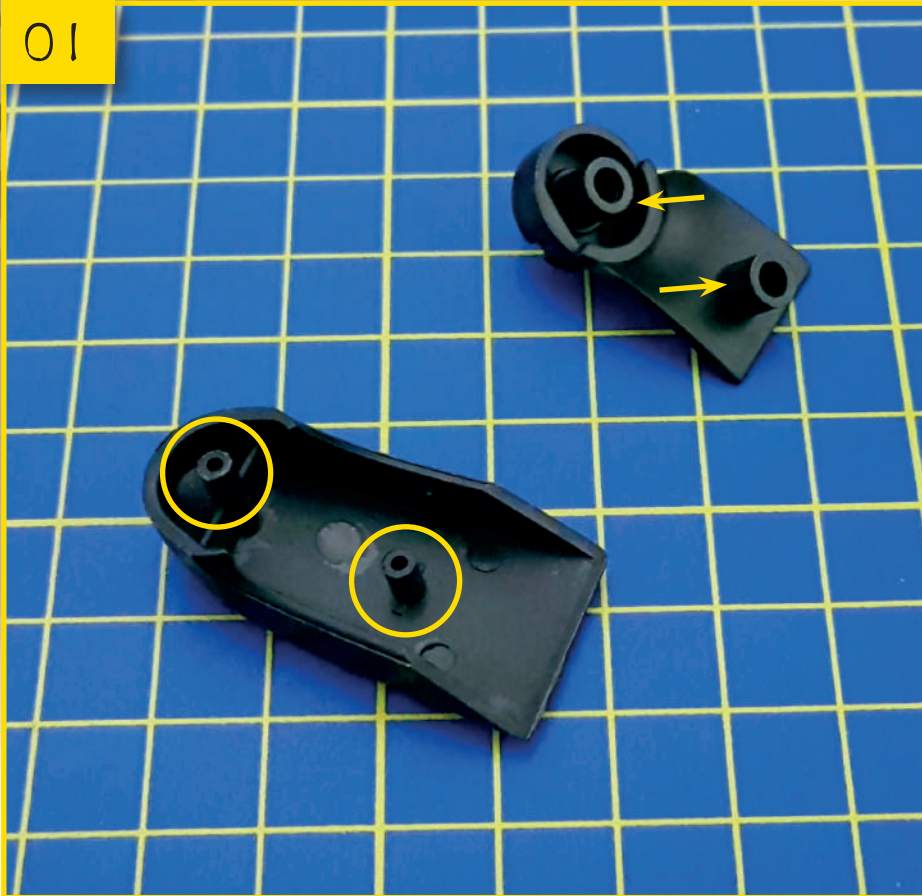

**43-01** Place the two parts of the brake air intake together on your work surface, so they are facing the direction shown in the image. You can see the interlocking structures that allow you to press the two parts together.

02



**43-02**

Join the two parts by pressing them together so that the interlocking structures can bond perfectly together.



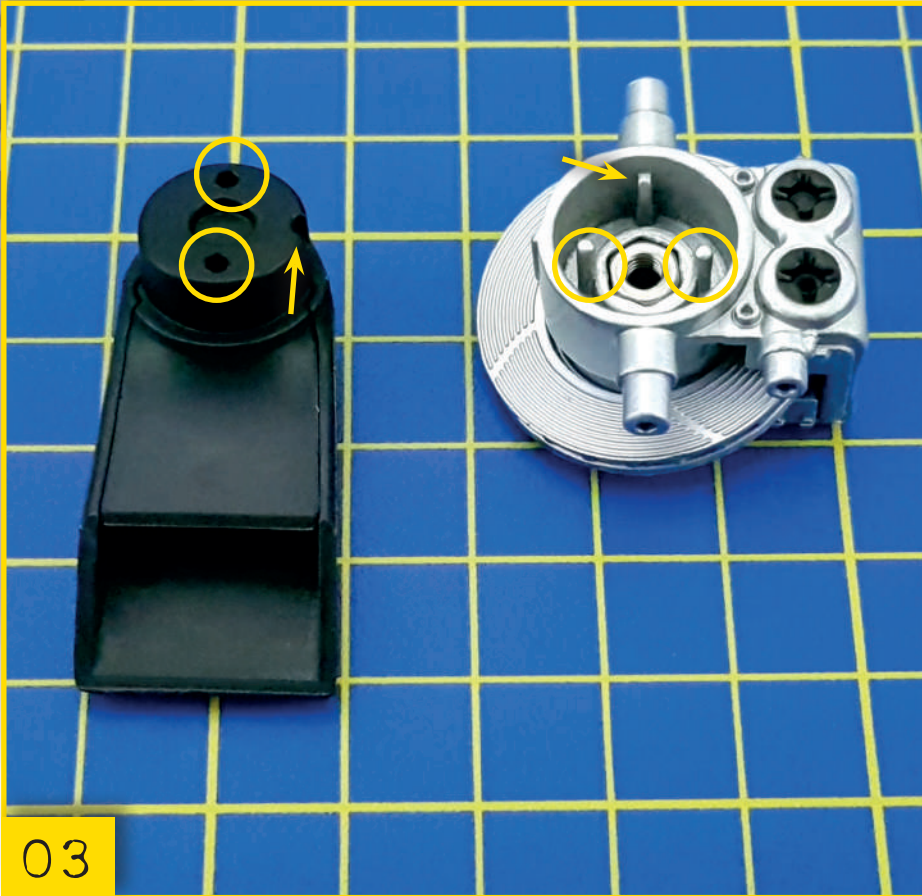

03

**43-03** Take the brake assembly that you built in the previous stage and place it alongside the air intake, as shown in the photo. The brake assembly has two pins (yellow circles) and a reference mark (yellow arrow); the air intake has two holes and a small recess.

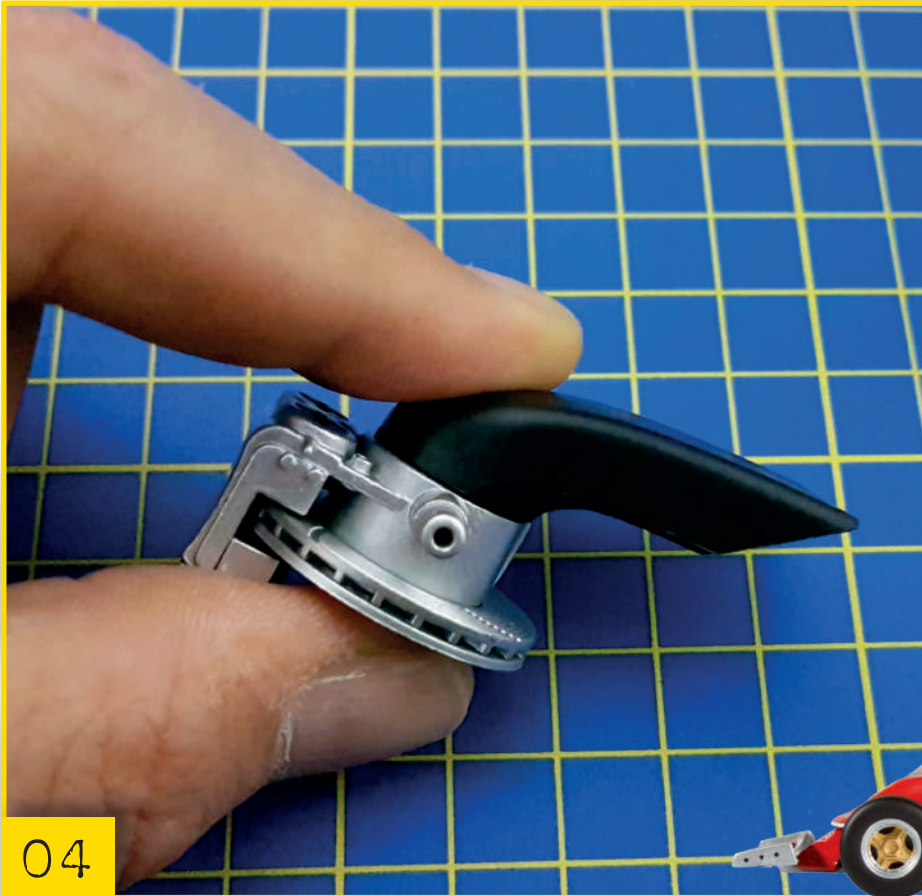

04

**43-04** Using the parts highlighted in the previous step, join the air intake to the front brake assembly.



**43-05** Now take the brake disc support. Join it to the brake disc. The pins and fixing holes mean they can simply snap together.

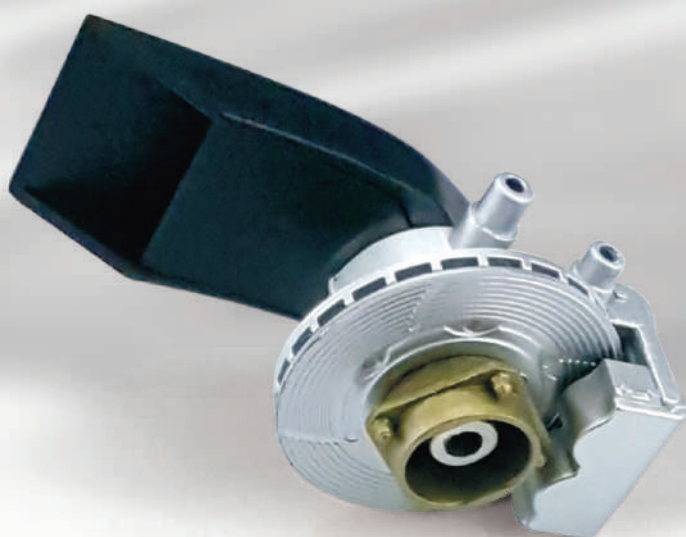
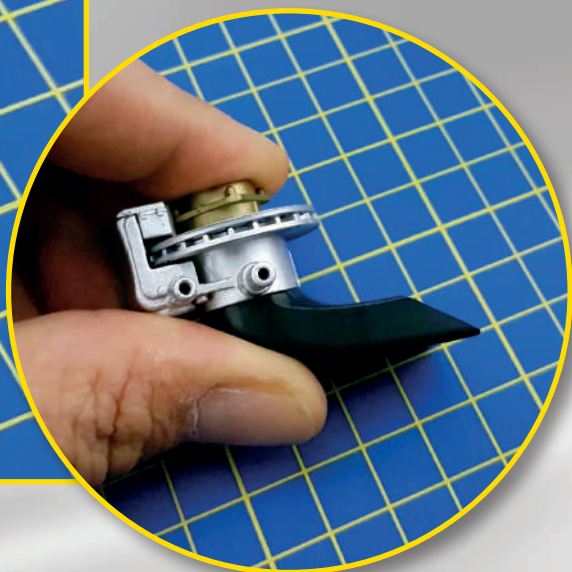
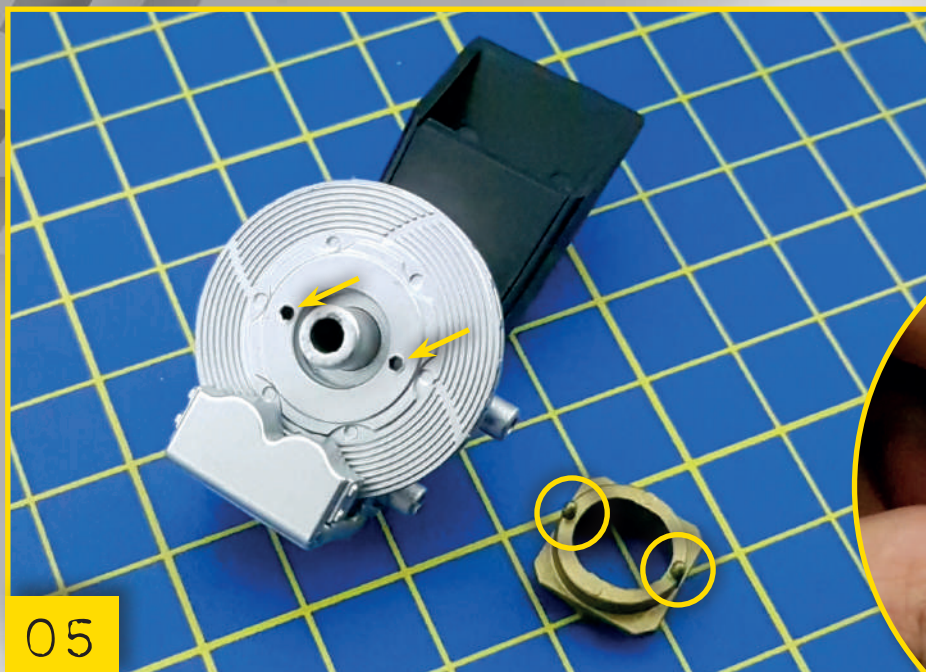

**FINAL RESULT**

You have just completed another important step in building the brake assembly on the second front wheel.



**In the next stage**

Parts for the front right suspension and the necessary screws for their assembly.





# WISHBONE ARMS

STAGE 44 INCLUDES THE PARTS THAT SERVE TO BUILD THE RIGHT FRONT SUSPENSION OF YOUR 1:8 SCALE FERRARI 312 T4. USING THESE INSTRUCTIONS, YOU CAN START TO BUILD THIS MECHANICAL ASSEMBLY.



## LIST OF PARTS

- 1 Lower arm
- 2 Steering slider
- 3 Shock absorber
- 4 Upper arm

## SCREWS

- Four type C screws
- Two type D screws





01

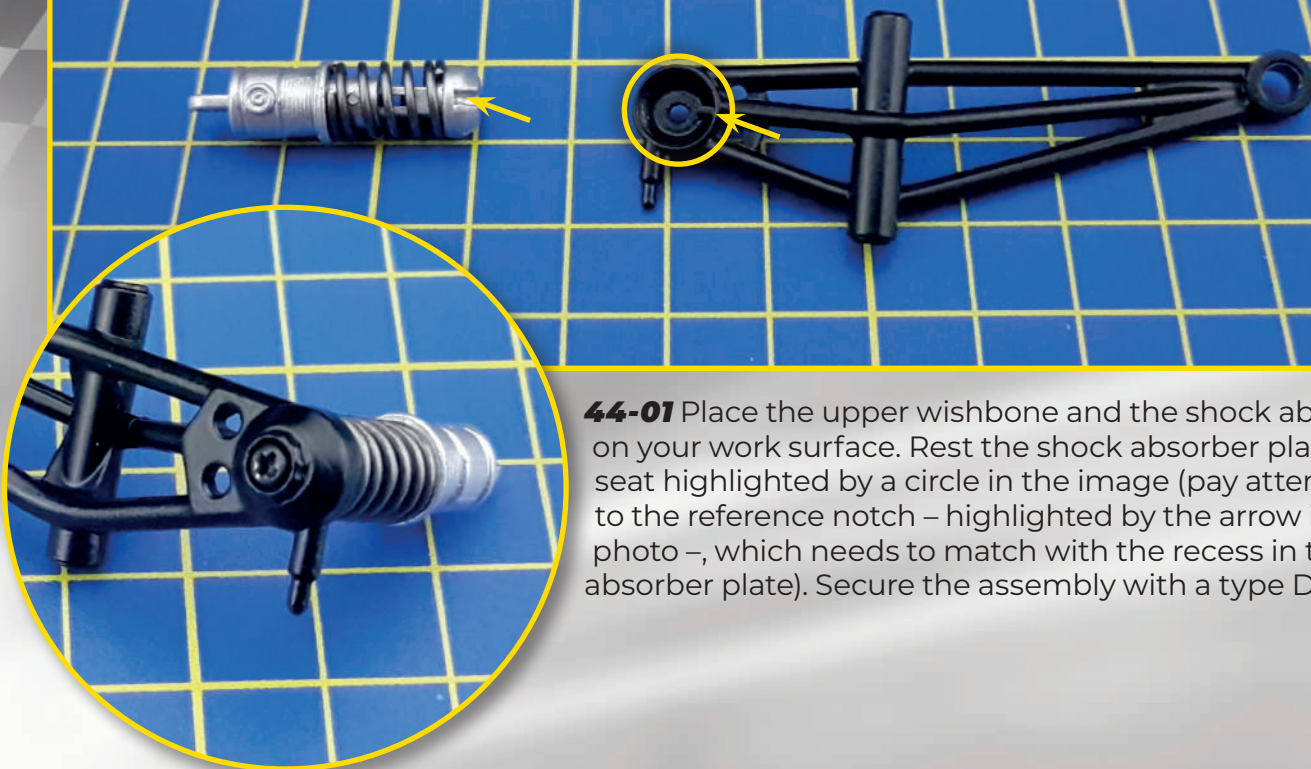

**44-01** Place the upper wishbone and the shock absorber on your work surface. Rest the shock absorber plate in the seat highlighted by a circle in the image (pay attention to the reference notch – highlighted by the arrow in the photo –, which needs to match with the recess in the shock absorber plate). Secure the assembly with a type D screw.

02

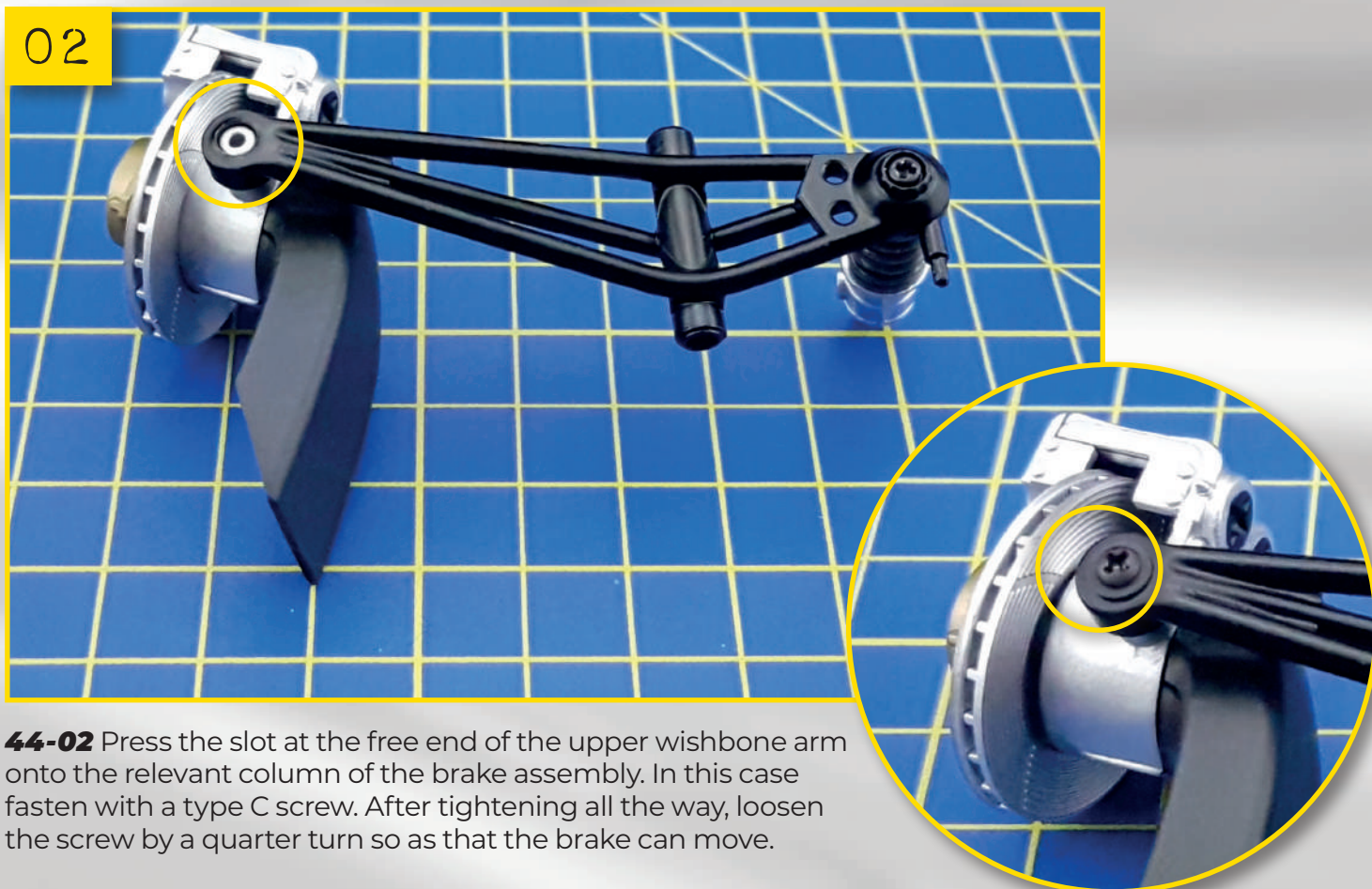

**44-02** Press the slot at the free end of the upper wishbone arm onto the relevant column of the brake assembly. In this case fasten with a type C screw. After tightening all the way, loosen the screw by a quarter turn so as that the brake can move.





03

**44-03** Take the lower wishbone arm and the steering slider. There are two columns to secure the brake assembly, shown by the circle in the image.



04

**44-04** Now it is the turn of the lower wishbone arm. In this case too, you should look at the images to ensure the parts are facing the right way. Use a type C screw for the lower arm.





**44-05** Lastly, place the steering slider and secure it with another type C screw.

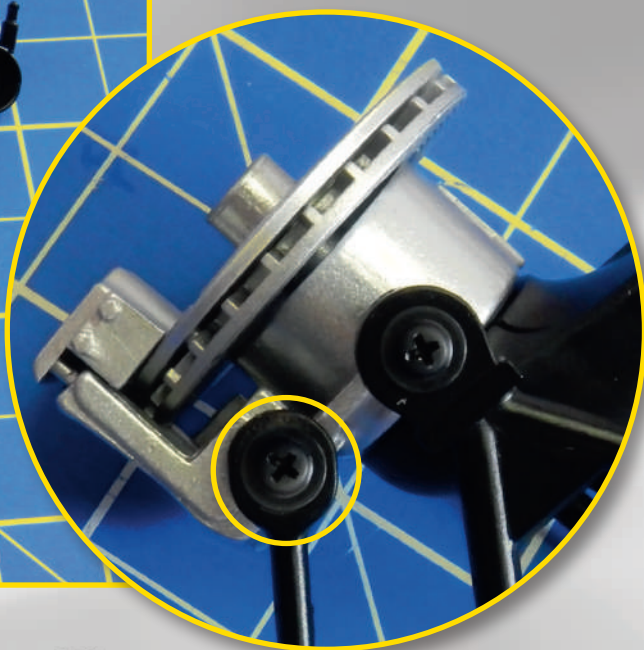
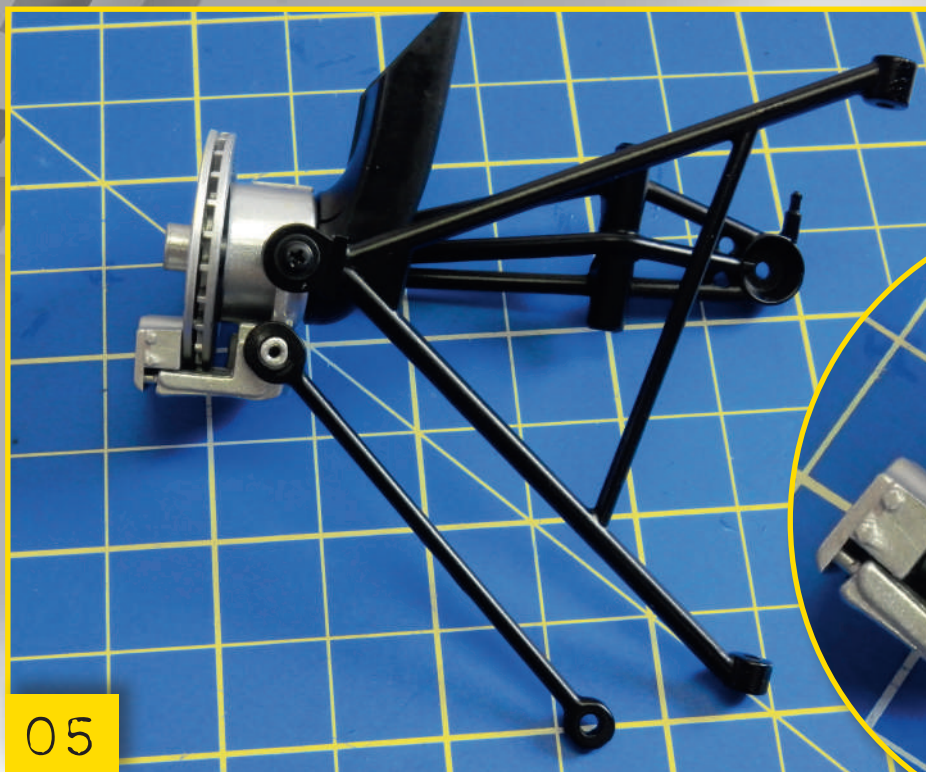

**FINAL RESULT**

Now you have started to build the right front suspension of your 1:8 scale Ferrari 312 T4.

**In the next stage**

New parts for the right front suspension and the screws needed to assemble the parts.





# PARTS TO SECURE SUSPENSION TO CHASSIS

NOW YOU HAVE THE PARTS YOU NEED TO COMPLETE THE RIGHT FRONT SUSPENSION AND SECURE IT TO THE CHASSIS OF YOUR FERRARI 312 T4.



## LIST OF PARTS

- 1 Front link
- 2 Rear link
- 3 Shock absorber
- 4 Hex-head screw
- 5 Rear suspension joint

## SCREWS

- Four type D screws
- Two type E screws
- Six type G screws
- Two type L screws

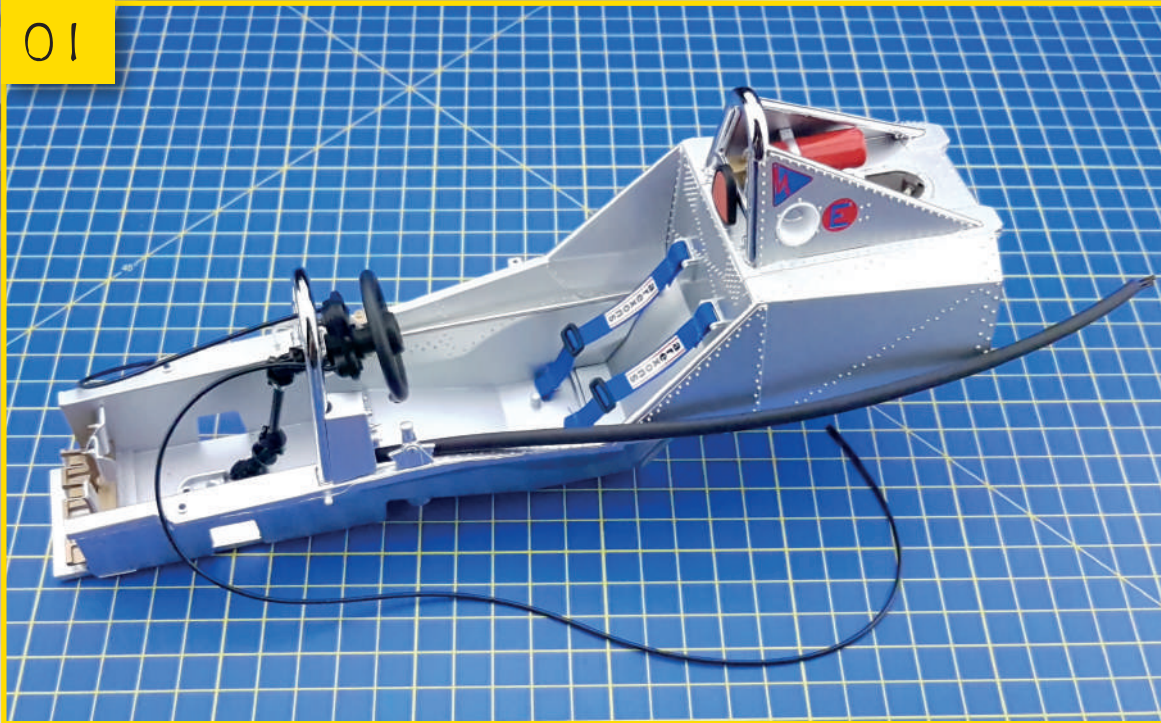

01

**45-01**

Take the cockpit cradle and the sheath provided with stage 30. Insert the three tubes from the console on the left of the steering wheel into the sheath.

02

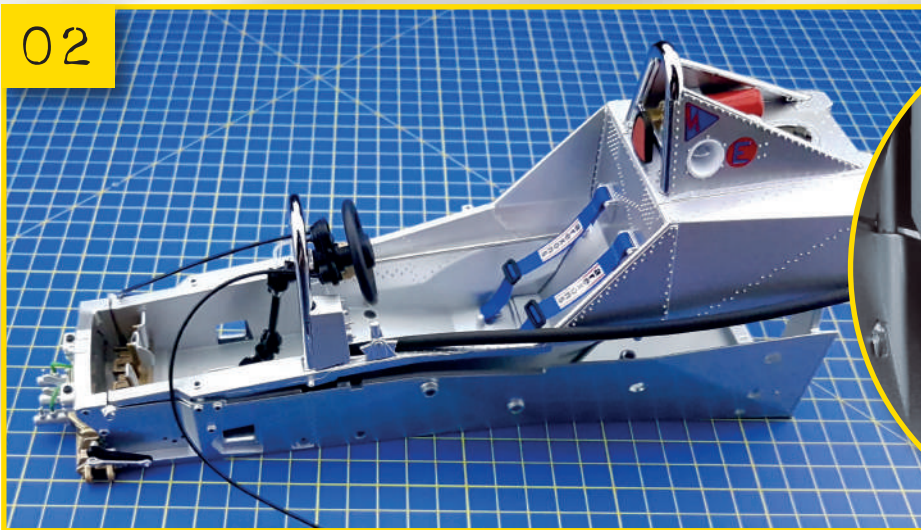

**45-02** Now place the cockpit cradle on the underbody, starting from the front. Press the rear section until the two pins (shown inside the inset photo) have slotted perfectly into the relevant columns.

**45-03** Place the front and back joints of the suspension in their correct position and fix them to the underbody using two type D screws. Important: the wider slots need to be facing the front of the car.

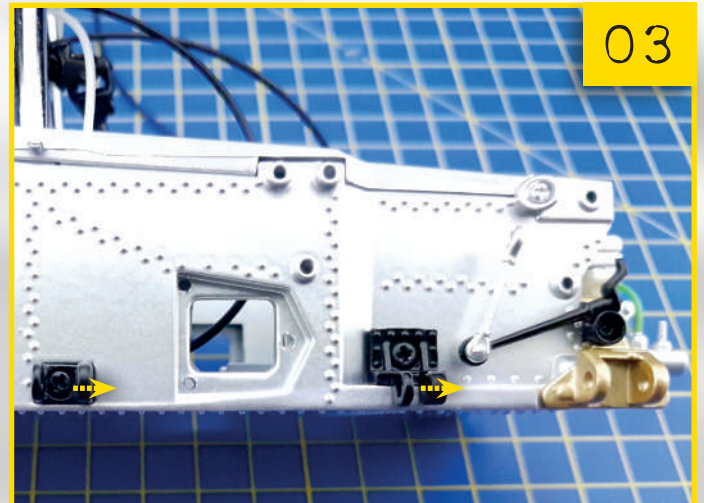



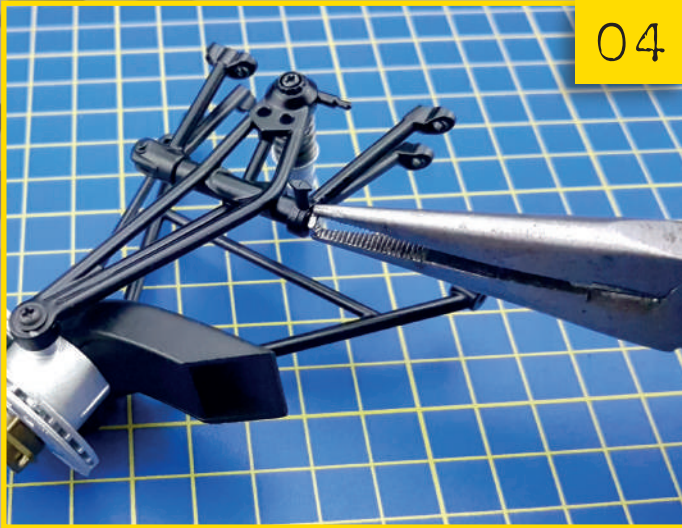

04

**45-04** Use the hex-head screw to join the upper wishbone arm to the front and rear links. Make sure the parts are facing the right way, as shown in the image.

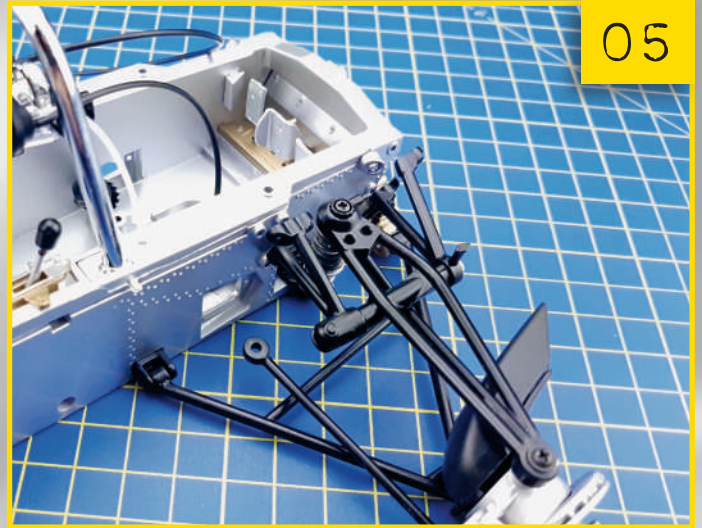

05

**45-05** Join the ends of the lower wishbone arm to the rear joint of the suspension and the master cylinder support. The bottom slot of the shock absorber must be inserted into the shock absorber joint.

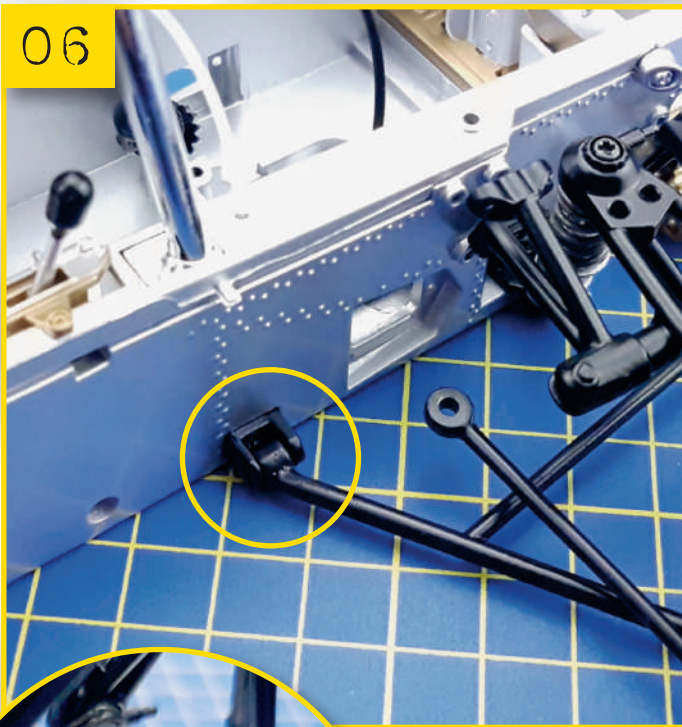

06

**45-06** Secure the lower wishbone arm in the rear joint using a type E screw. Use another type E screw to secure the shock absorber.

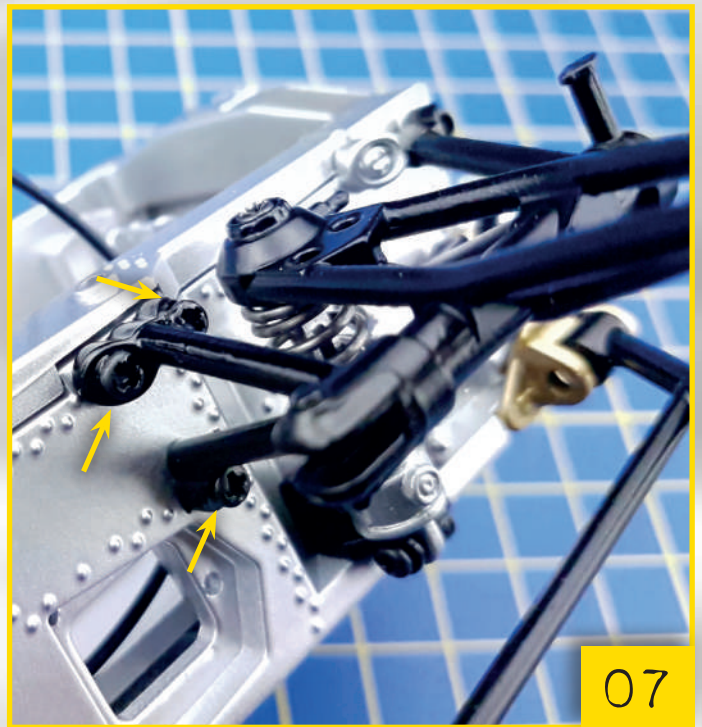

07

**45-07** Using three type G screws, fasten the rear track rod of the suspension under the underbody.



#### 45-08

Now it is time for the front track rod. Bring the two assembly holes into line with those of the bottom plate, then secure with two type G screws.

08

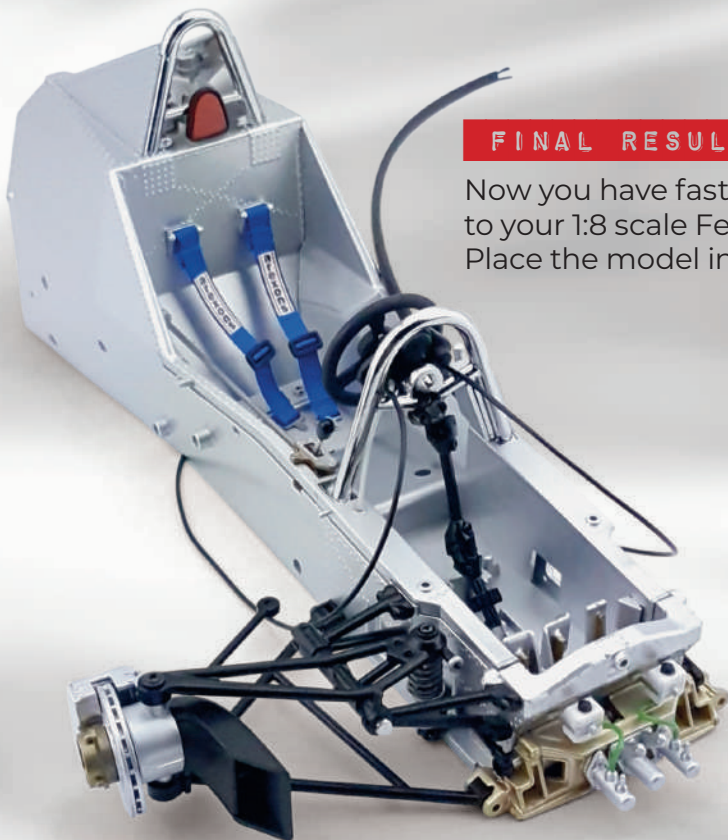
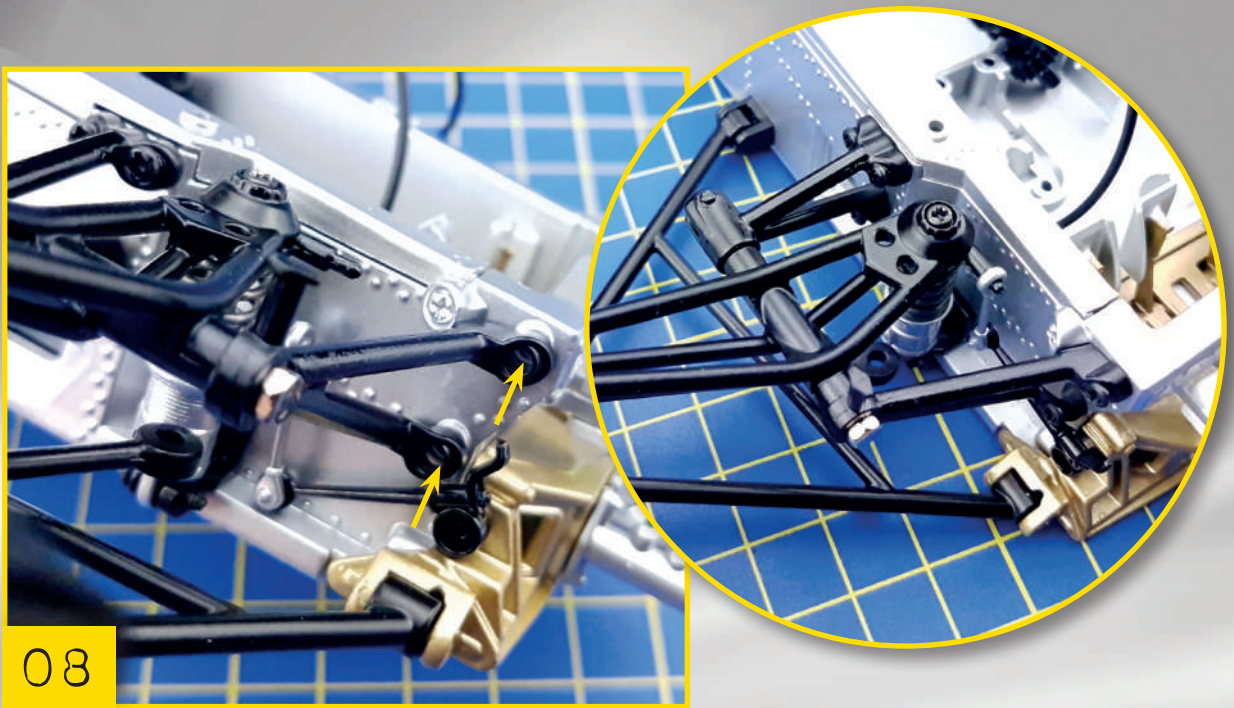

#### FINAL RESULT

Now you have fastened the front right suspension to your 1:8 scale Ferrari 312 T4. Place the model in a safe place.

#### In the next stage

The suspension mounting brackets and joints, together with the screws needed for assembly.



# LEFT SUSPENSION JOINTS AND WISHBONE ARMS

WITH THE CONTENTS OF THIS STAGE YOU CAN SECURE THE FRONT LEFT SUSPENSION TO THE CHASSIS, COMPLETING THE FRONT OF YOUR 1:8 SCALE FERRARI 312 T4.



4 type D screws



3 type E screws



3 type F screws



6 type G screws



5 type N screws



## LIST OF PARTS

- 1 Left wishbone arm
- 2 Right wishbone arm
- 3 Rear suspension joint
- 4 Shock absorber

## SCREWS

- Four type D screws
- Three type E screws
- Three type F screws
- Six type G screws
- Five type N screws





**46-01**

Place the two joints on the left side of the chassis and secure them with two type D screws.

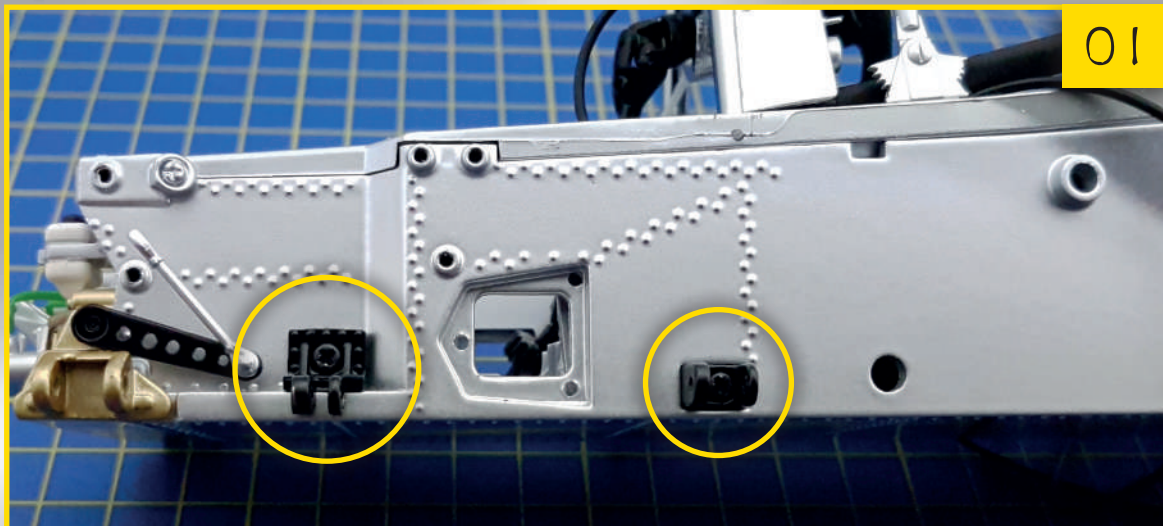

## 02

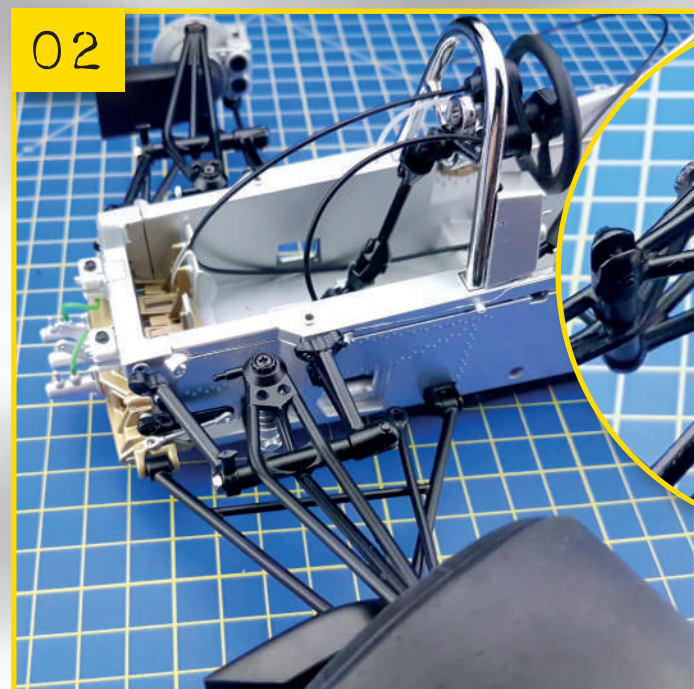

**46-02** Join the ends of the lower left suspension arm (which you built in the assembly stage for stage 6) to the rear suspension joint and the master cylinders support. The bottom slot of the shock absorber must be inserted into the shock absorber joint. Insert two type E screws into the brackets in question.

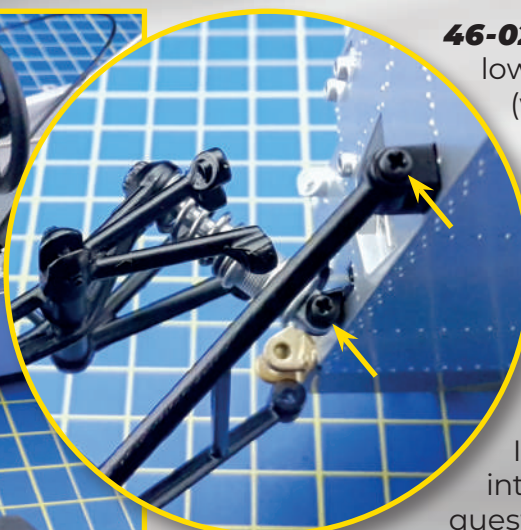

## 03

**46-03** With three type G screws, fasten the rear track rod of the left wishbone to the chassis. Then pass on to the front track rod. Bring the two assembly holes into line with those of the chassis then secure with two type G screws. You may find this easier if you remove the wheel first.

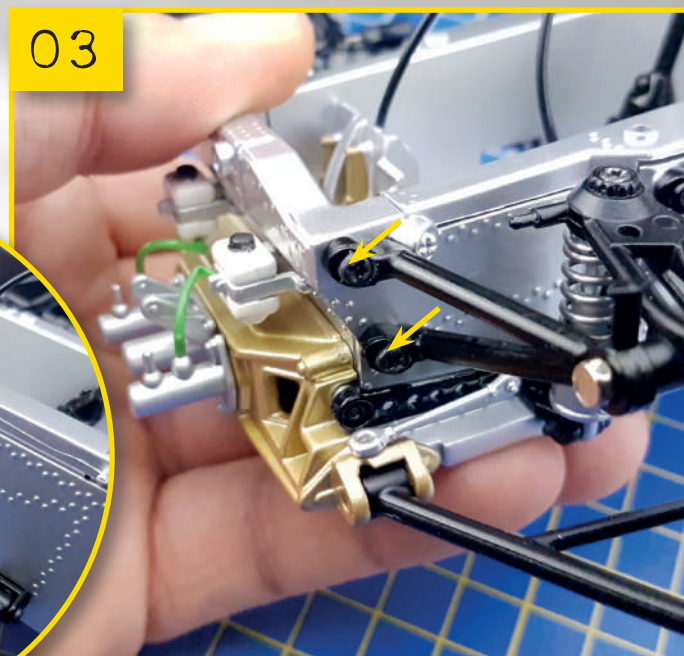



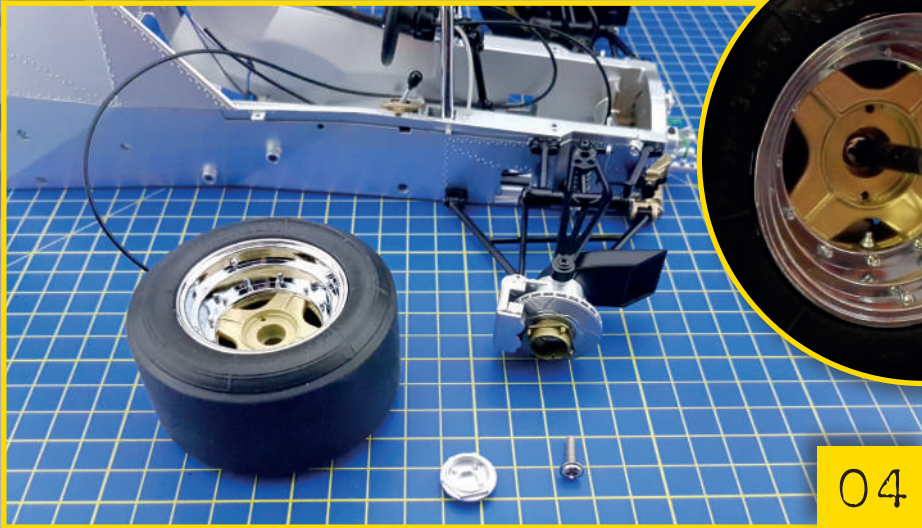

04

**46-04** Take the front wheel, a type L screw and the hubcap, included in previous stages. Fix the wheel to the left front suspension assembly using the type L screw.

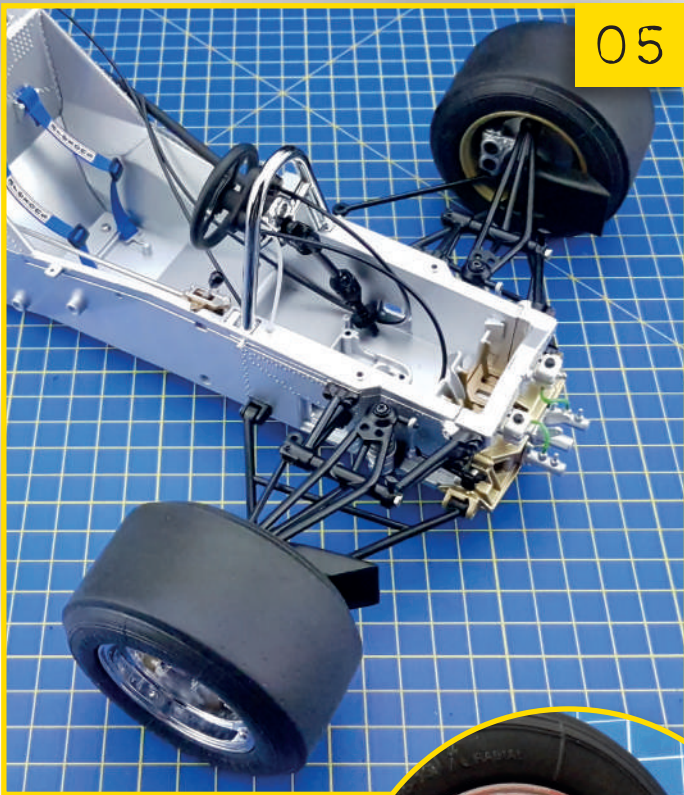

05

**46-05** All that is left is to position the hubcap, using the two assembly pins. Now the two front wheels are joined to the model being constructed.



06

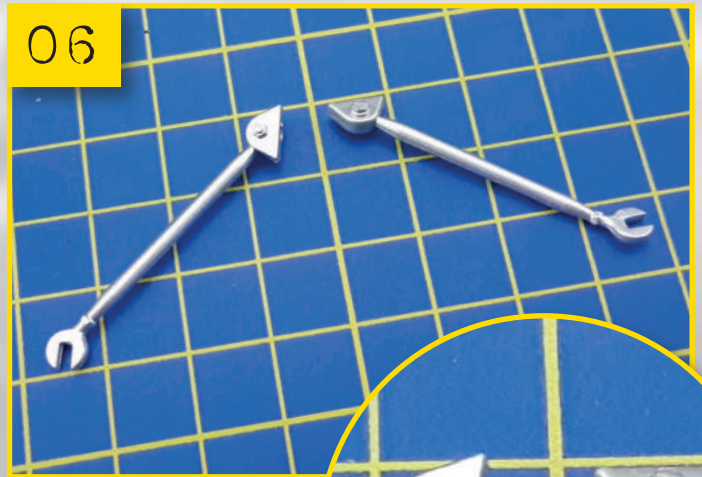

**46-06** Take a close look at the image of the wishbone arms. Their almost triangular end has a reproduction of a flanged hex-head screw on one side, and on the other, the copy of a nut and the end of a screw. The first, which is the face with the bolt head (on the right in the photo) is the side that needs to be facing upwards.

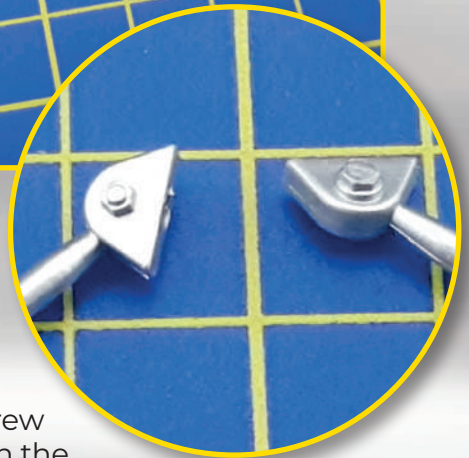



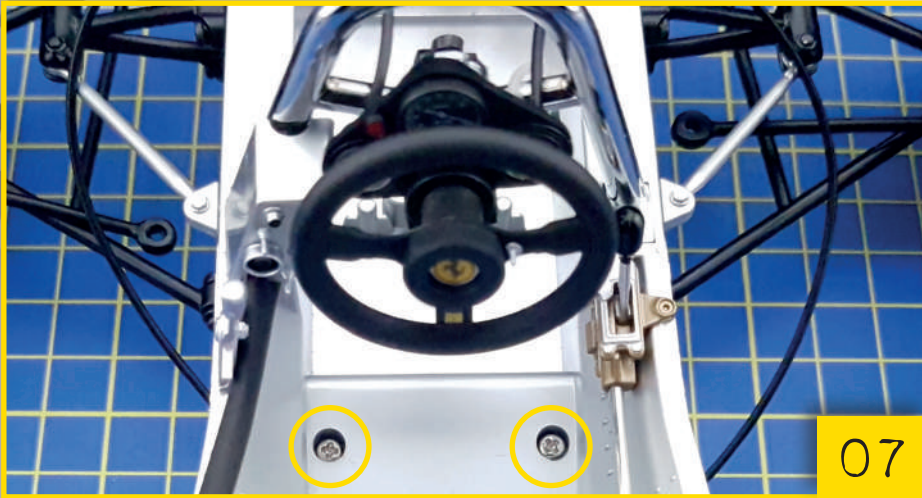

#### 46-07

Fit the wishbones in question. For each arm, couple the fork-shaped end into the suspension support, and the triangular shape in the relevant peg in the chassis. Then drive two type N screws into the positions indicated in the image.

#### 46-08

Take two more type N screws and insert them in the positions circled in the image.

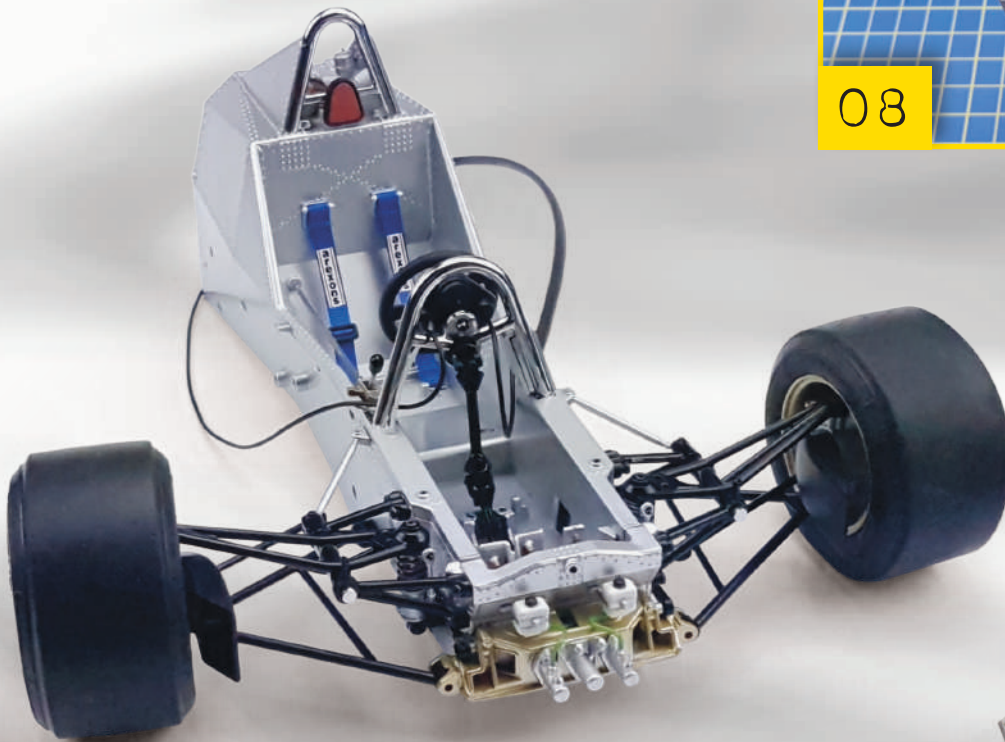
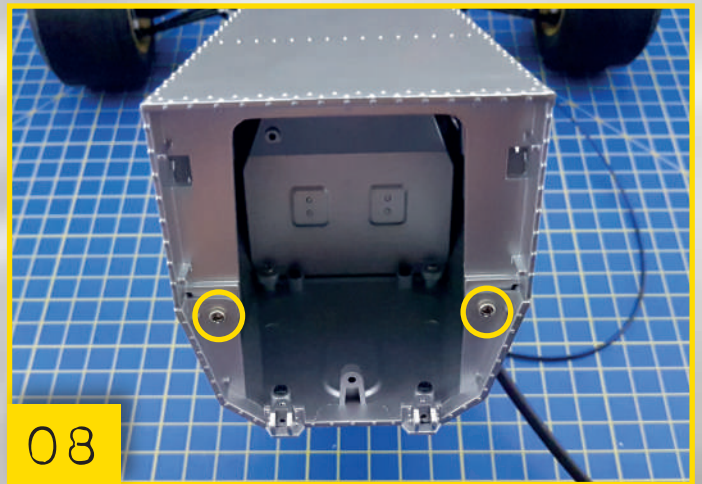

#### FINAL RESULT

You have completed the assembly of the mechanical parts in the front section of your 1:8 scale Ferrari 312 T4. Place the model in a safe place.

#### In the next stage

Brake line connections, the first parts for the steering system, and the assembly screws.





# BRAKE LINE FITTINGS AND FIRST STEERING PARTS

NEXT YOU'LL BE ASSEMBLING THE BRAKE LINES. THESE CAN BE BUILT WITHOUT ADDING THE METAL LINER, BUT INCLUDING IT GIVES A MORE REALISTIC RESULT.



## LIST OF PARTS

- 1 Reinforcement plate for steering wheel support frame
- 2 Steering joint plate
- 3 Steering rack
- 4 Front brake line fittings

## SCREWS

Five type E screws  
Four type J screws



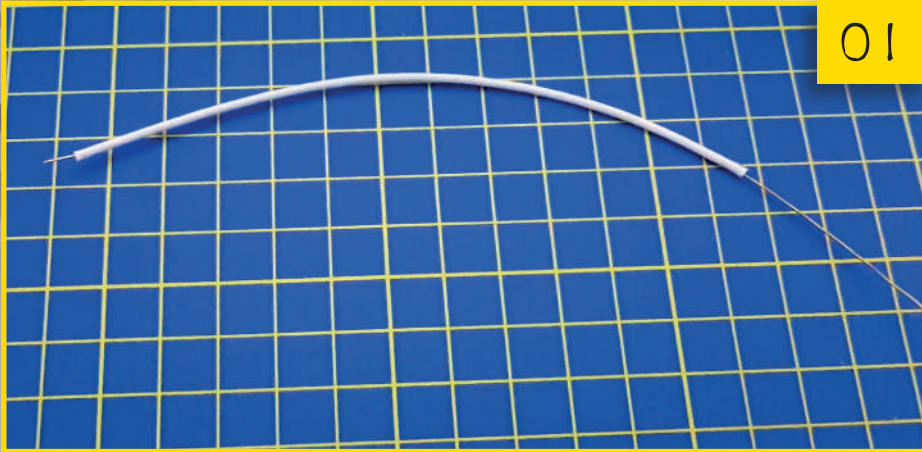

**47-01** Take a length of the same metal wire used to tie the spark plug cables (stage 18). Take the brake lines, installed on the master cylinders in the assembly steps in stage 39 and then removed in stage 41. Insert a piece of metal wire into one of the brake lines. The line is 130 mm long; the metal lining must be about 124 mm.

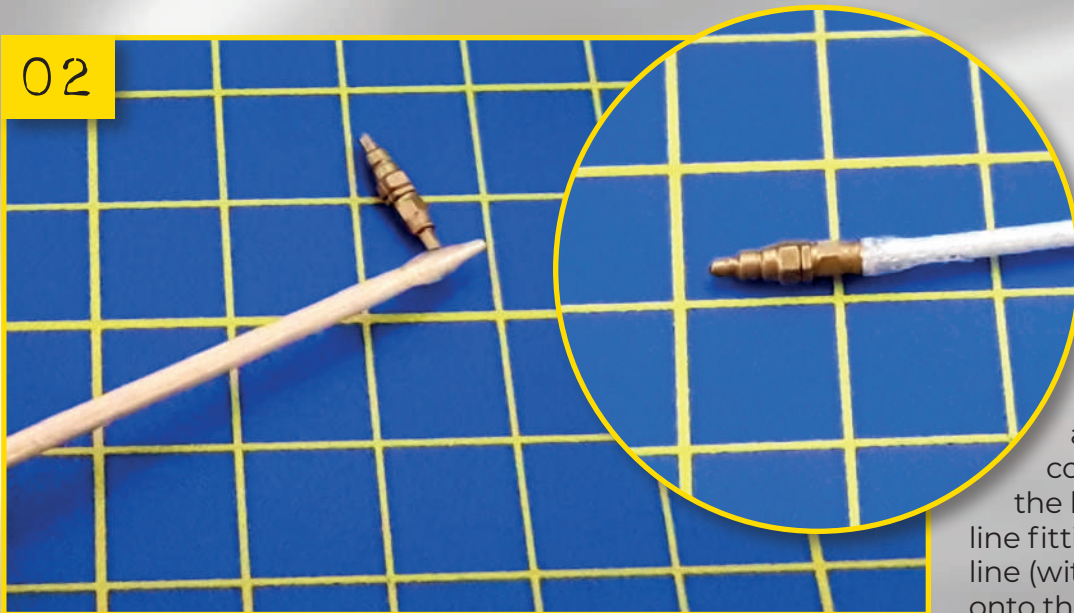

**47-02** Apply a small amount of two-component adhesive to the longer end of a brake line fitting. Then push a brake line (with metal wire lining) onto this end.

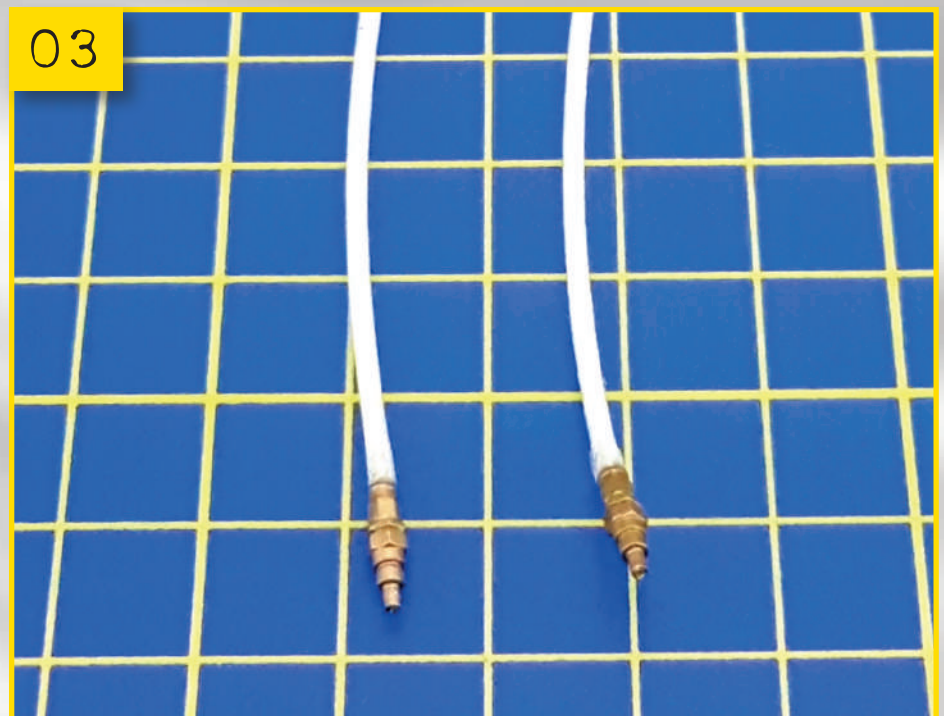

**47-03** Follow the same steps to complete the second brake line, adding the metal lining and fitting.



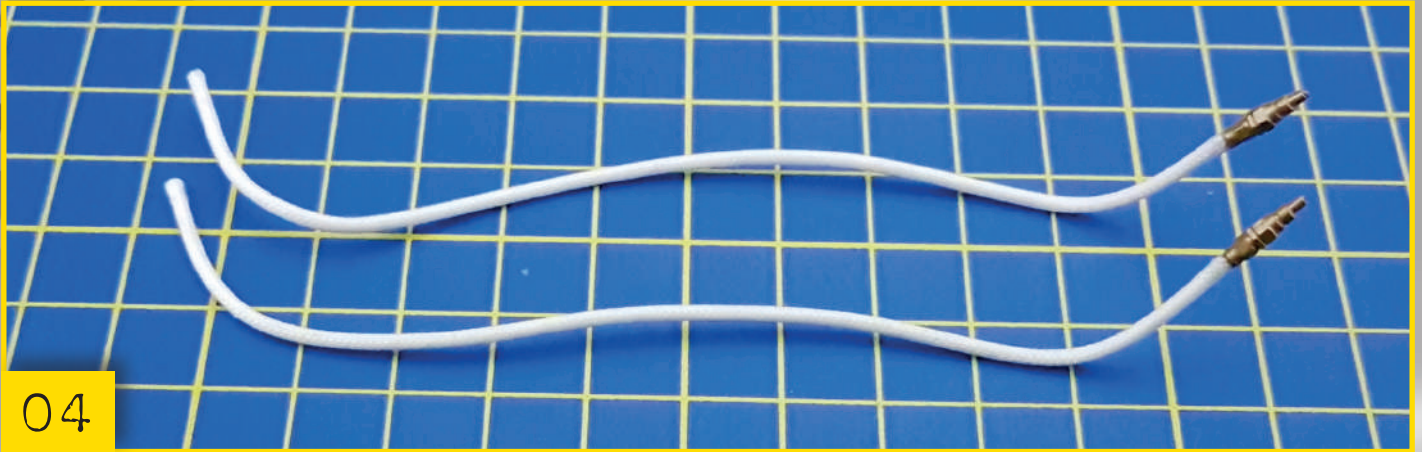

04

**47-04** Thanks to the metal wire inside the brake lines, these can be shaped as required. Bend the two lines so that they take on the approximate shape you can see in the image.

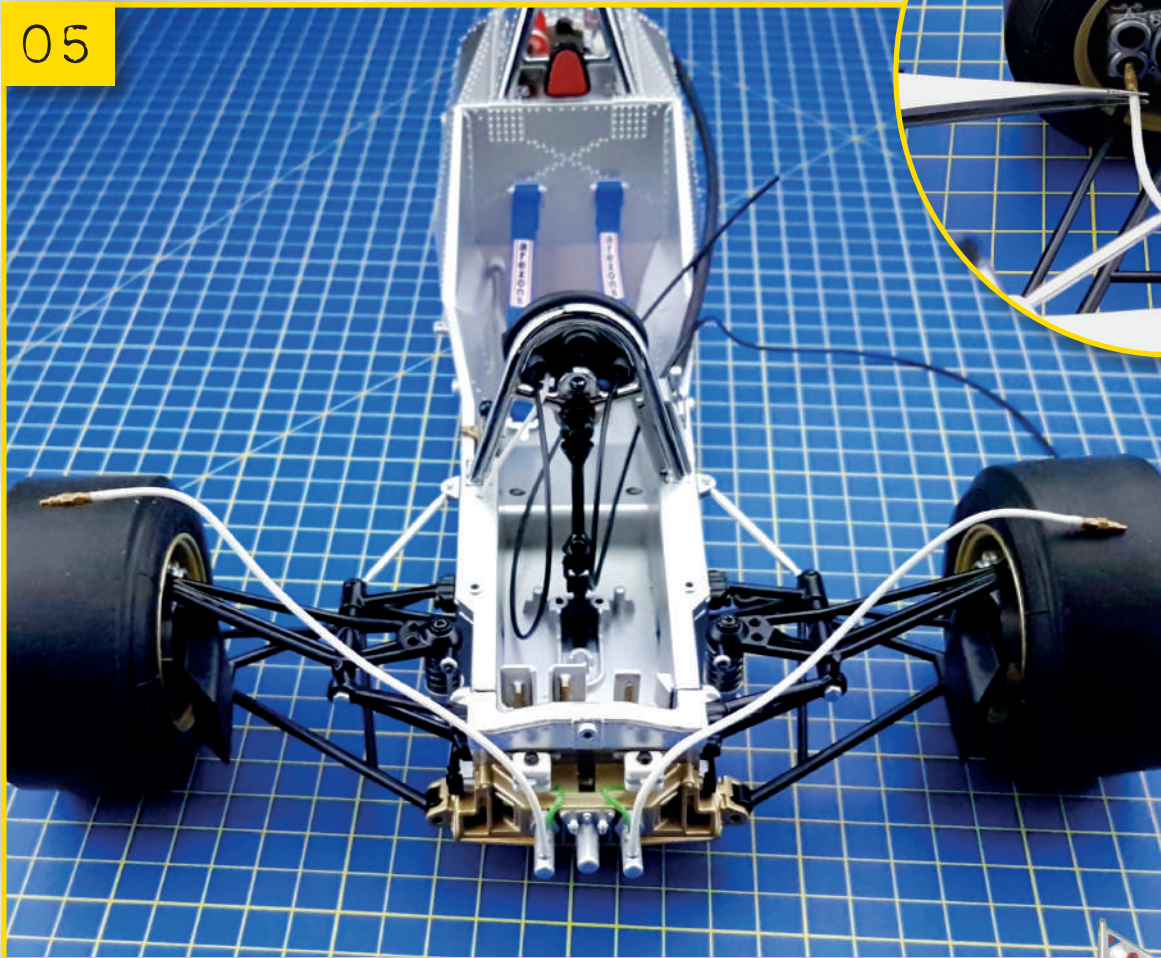

05

**47-05** Glue the finished lines to the master cylinders and bottom pistons of the callipers. Make sure the lines follow the same path as shown in the images.







**47-06** Using the same metal wire, tie the right front brake line to the lower wishbone on the suspension in two places.

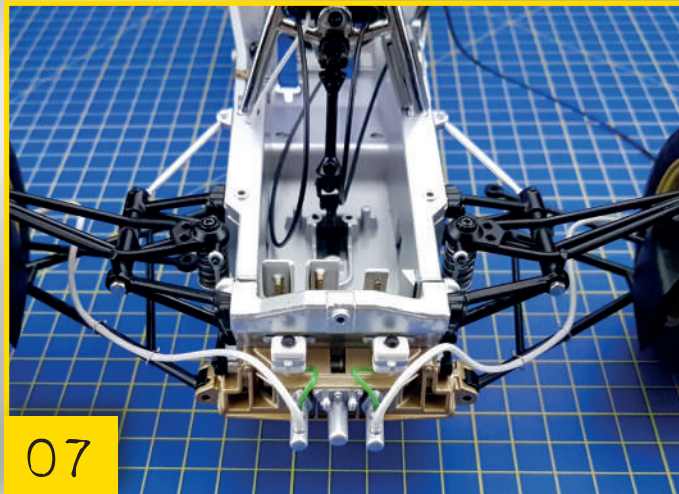

**47-07** Repeat this process for the left side.



### FINAL RESULT

Now you have fastened the front brake lines of your 1:8 scale Ferrari 312 T4.

### In the next stage

The left and right sides of the bodywork and some screws.

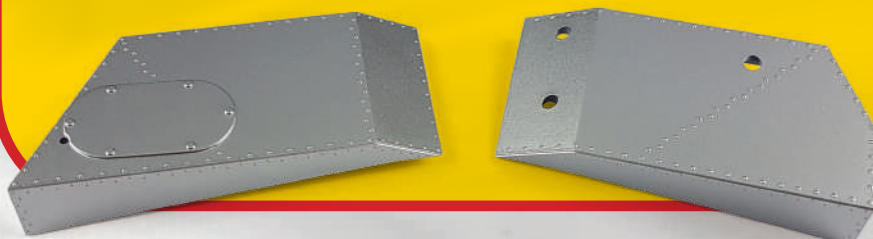



# LEFT AND RIGHT SIDES OF THE BODYWORK

FOLLOW THE INSTRUCTIONS TO FIT THE NOSE TO YOUR MODEL AND COMPLETE THE STEERING MECHANISM OF YOUR 1:8 SCALE FERRARI 312 T4.

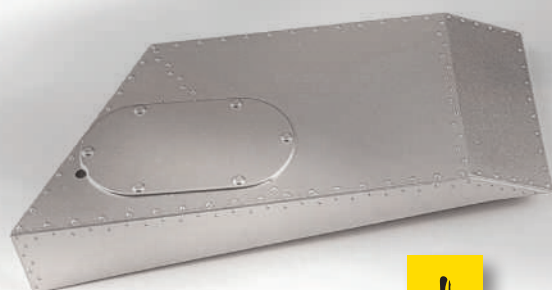

1



2

4 type P screws



## LIST OF PARTS

- 1 Left side of bodywork
- 2 Right side of bodywork

## SCREWS

Four type P screws



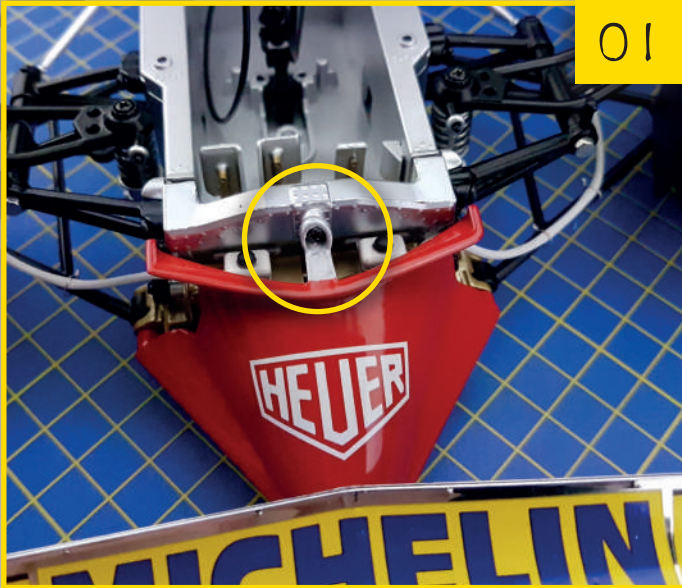

**48-01** Join the nose to the monocoque so that the upper hook of the nose is lined up with the top of the monocoque. Tighten in place with a type E screw.

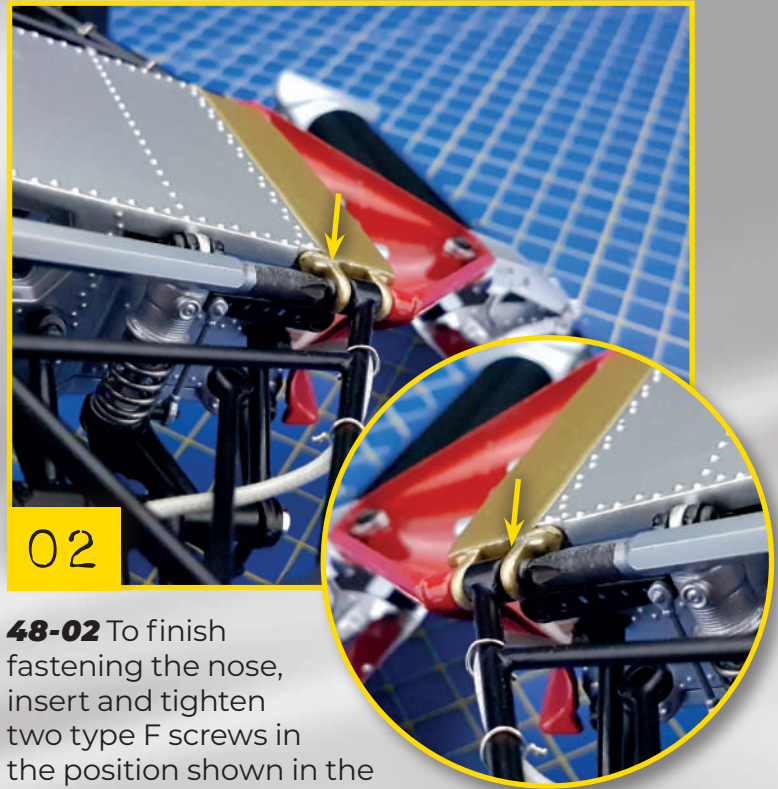

**48-02** To finish fastening the nose, insert and tighten two type F screws in the position shown in the images. Each screw crosses the wishbone arms and is then inserted into the relevant hole in the nose.

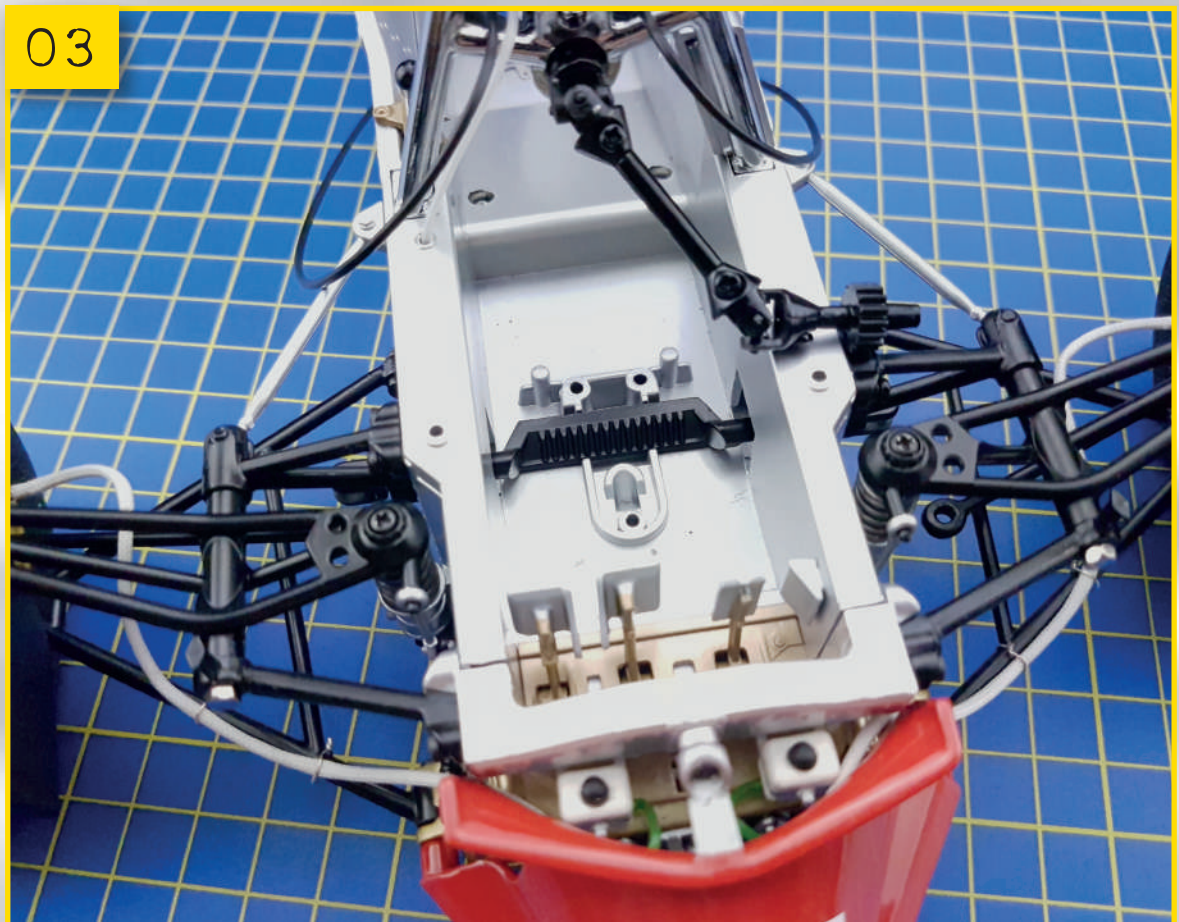

**48-03** Move the steering column to one side and put the rack into position, so it is facing the same way as shown in the image.



04

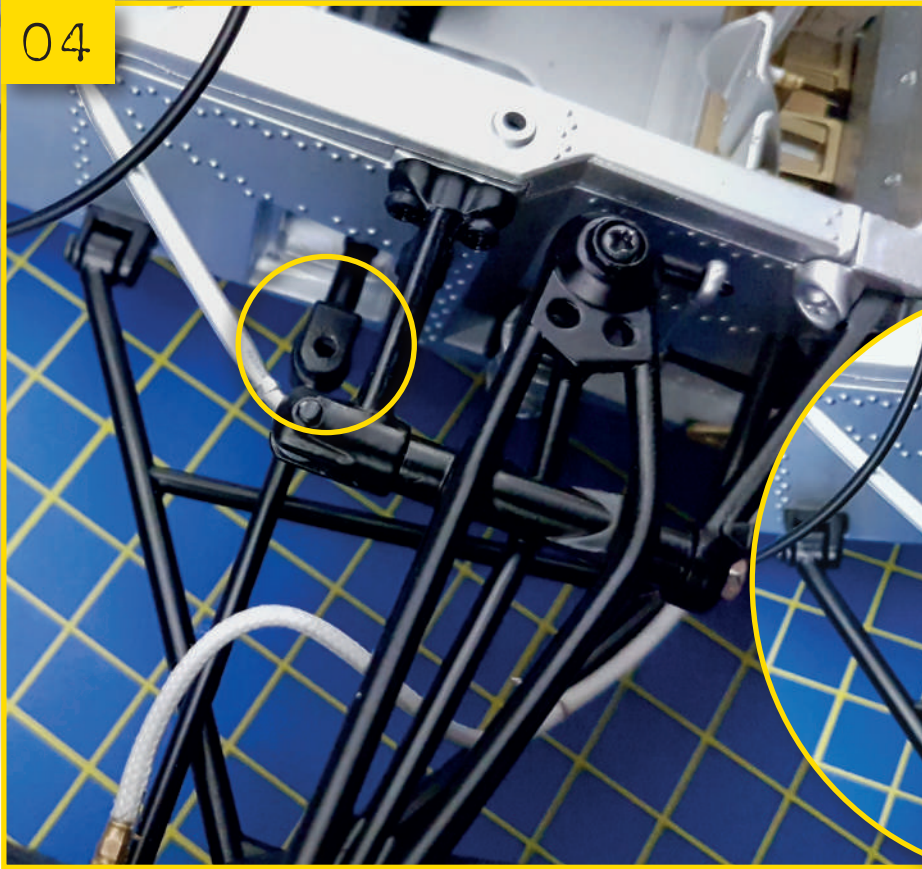

**48-04** The ends of the rack must be secured to the steering arms from the wheel hubs, using two type E screws. Make sure not to over-tighten the screws.



05

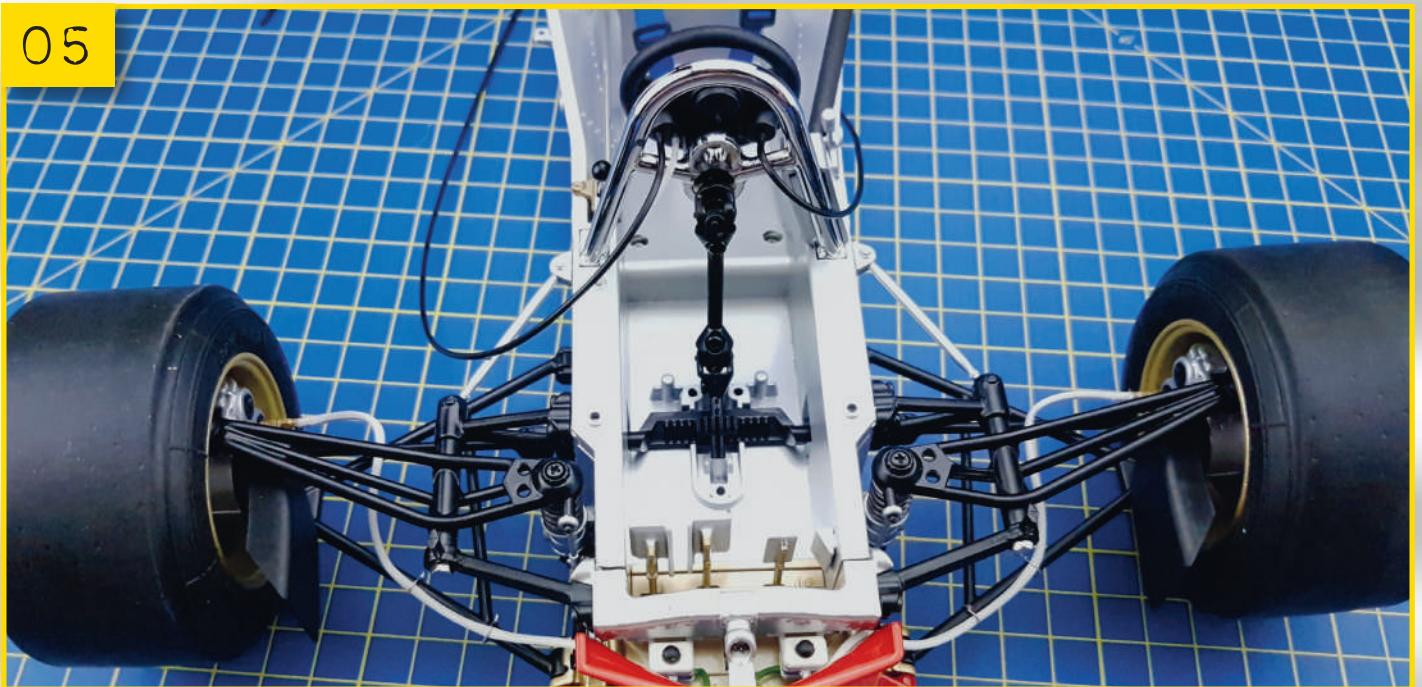

**48-05** Move the steering column to the correct position, so that the pinion teeth mesh with those on the rack. Make sure that the wheels are parallel to the vehicle axle and that the steering wheel is in the neutral position, which means the main spoke is facing downwards.





06

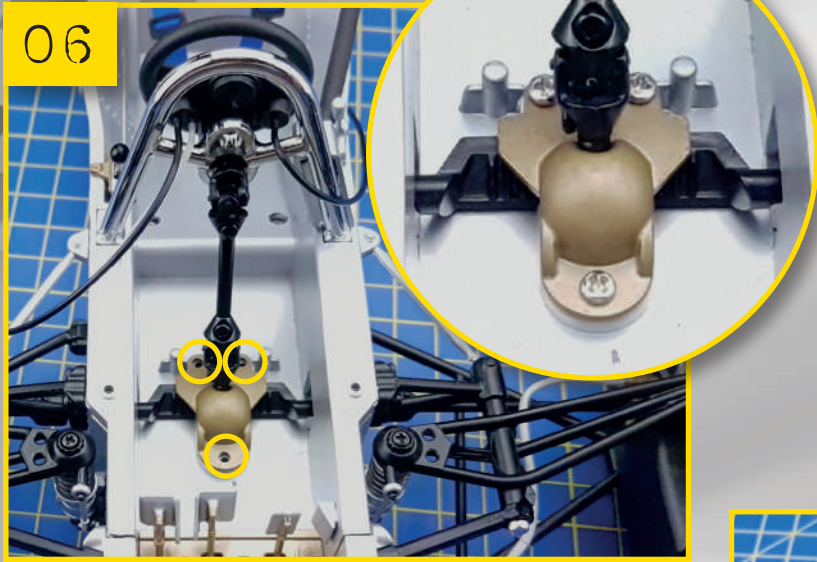

**48-06** Now place the protective plate of the steering joint in the position shown in the photograph. Secure the plate using three type J screws as shown in the inset.

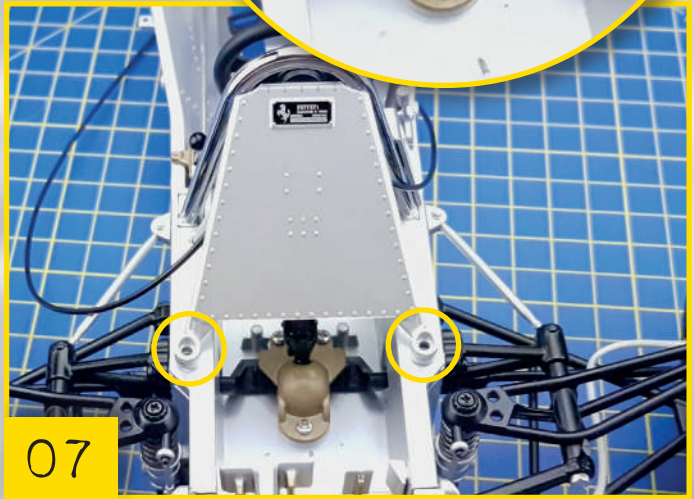
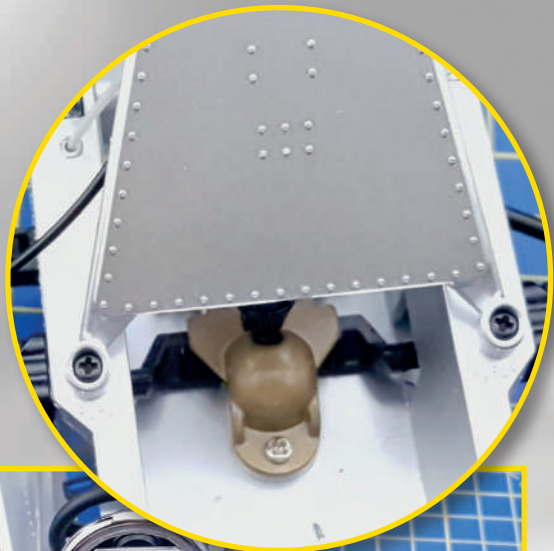

07

**48-07** Then fit the reinforcement plate sub-frame of the steering wheel to the model. Fix the part using two type D screws.



**FINAL RESULT**

The steering mechanism on your model is now fully operational. You have also joined the nose to the monocoque. Carefully put the model to one side before the beginning the next stage.

**In the next stage**

The small cross wrench and the fastening rings to close the seats of the rack.





# CROSS WRENCH AND DRAG LINK PLATES

FOR THIS ASSEMBLY,  
YOU'LL JOIN THE ENGINE  
ASSEMBLY TO THE  
COCKPIT OF YOUR 1:8  
SCALE FERRARI 312 T4.

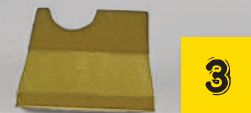
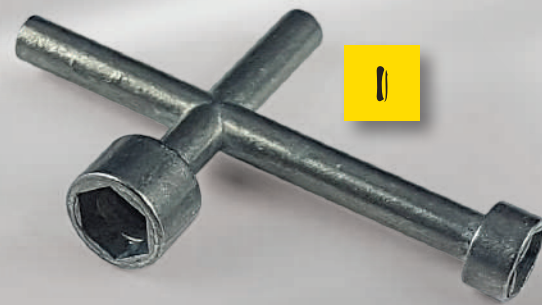

## LIST OF PARTS

- 1 Cross wrench
- 2 Cover plate for left drag link B
- 3 Cover plate for right drag link B
- 4 Cover plate for left drag link A
- 5 Cover plate for right drag link A



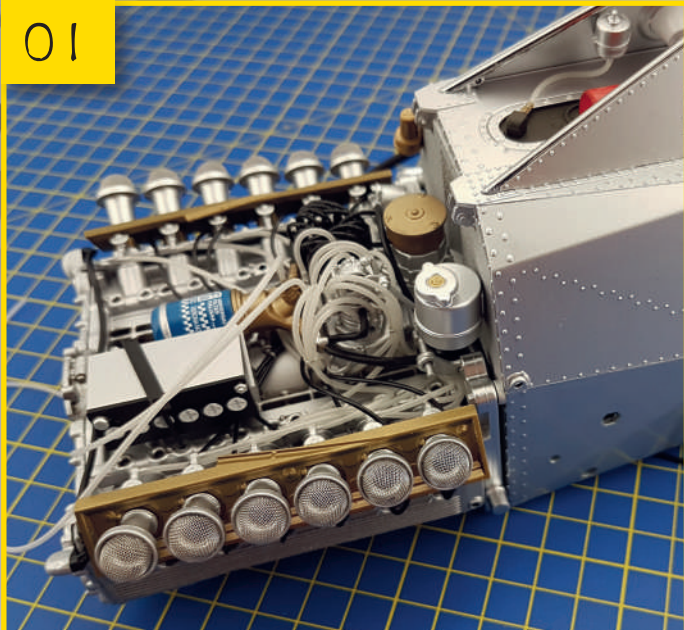

**49-01** Join the engine and monocoque assemblies together.

**49-02** Tighten a type P screw on the right side of the monocoque so that the assembly is stable. Do the same for the left side of the model.

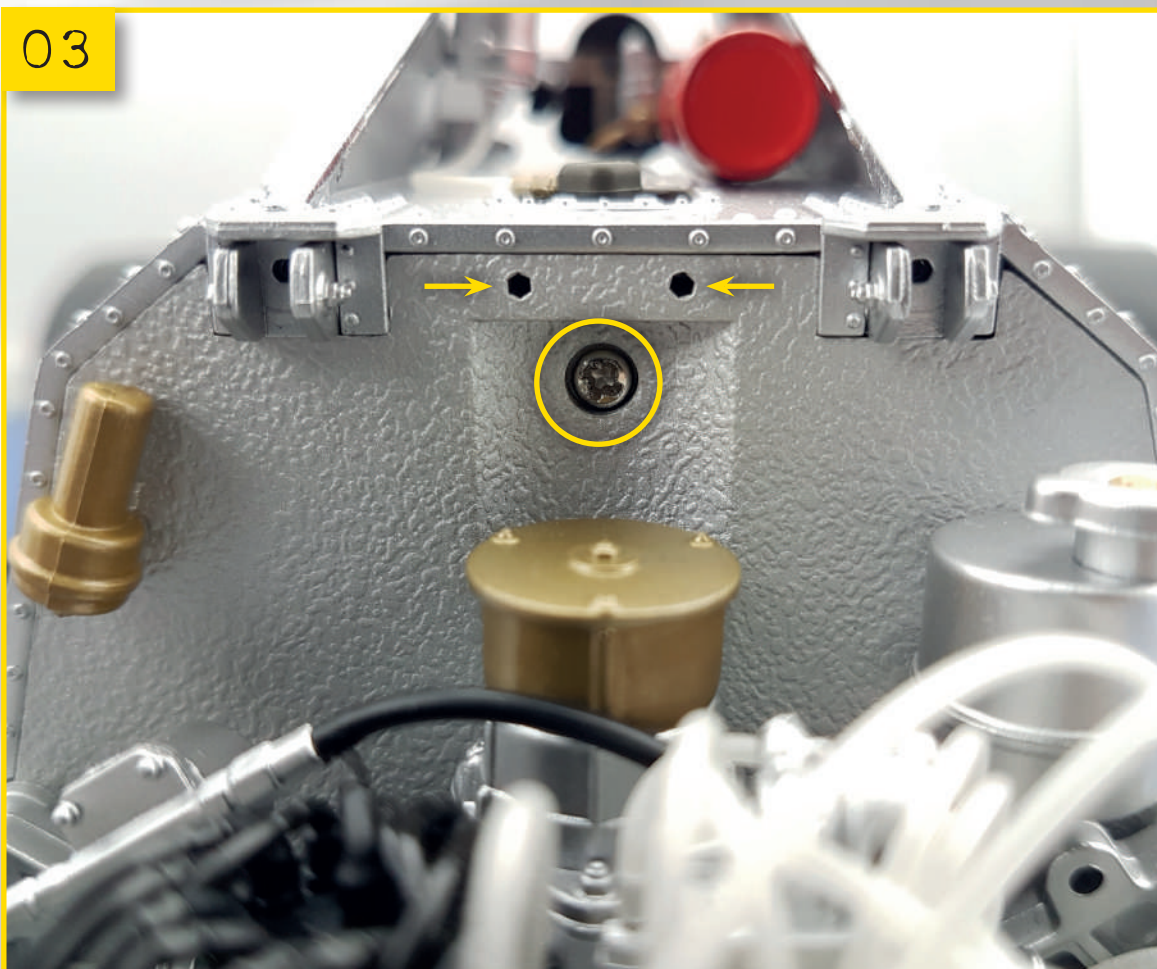
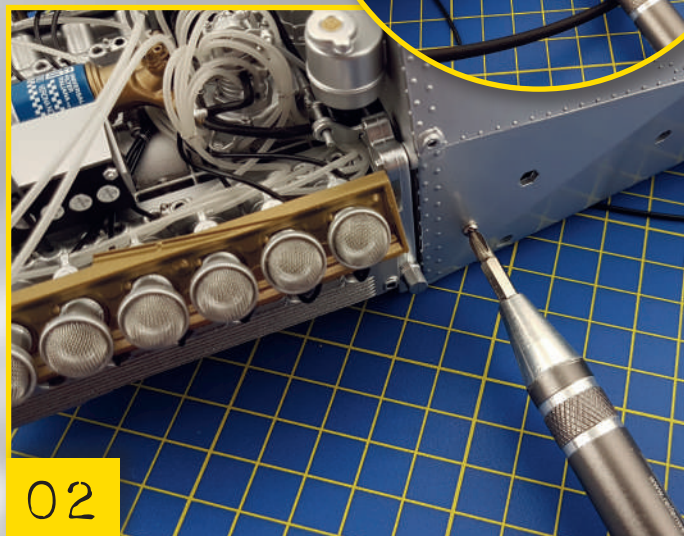
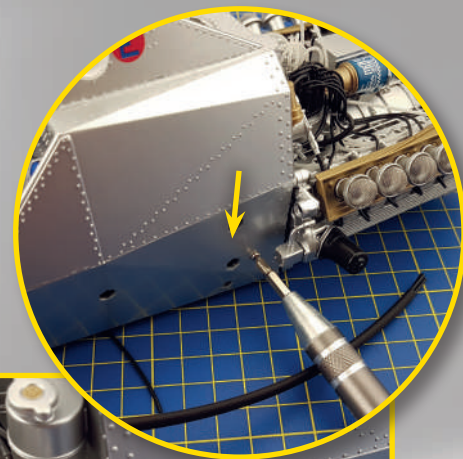

**49-03** Use another type P screw to fasten the top of the monocoque in the centre. The arrows in the image show the holes for assembling the plate of the fire extinguisher.



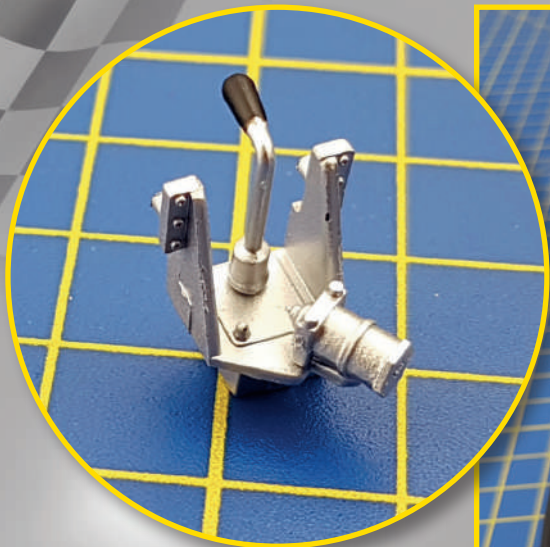

**49-04** Recover the previously assembled fire extinguisher, built in stage 37 (see the inset image). Fit it to the model, inserting the two fastening pins on the plate into the holes identified in the previous step.

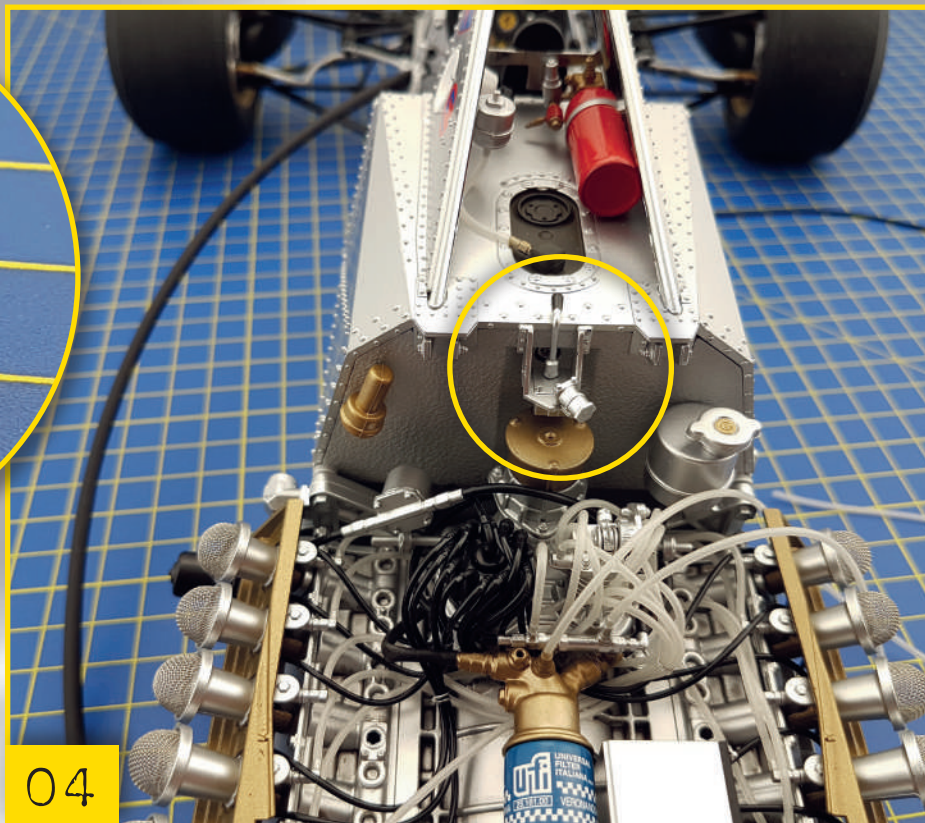

04

05

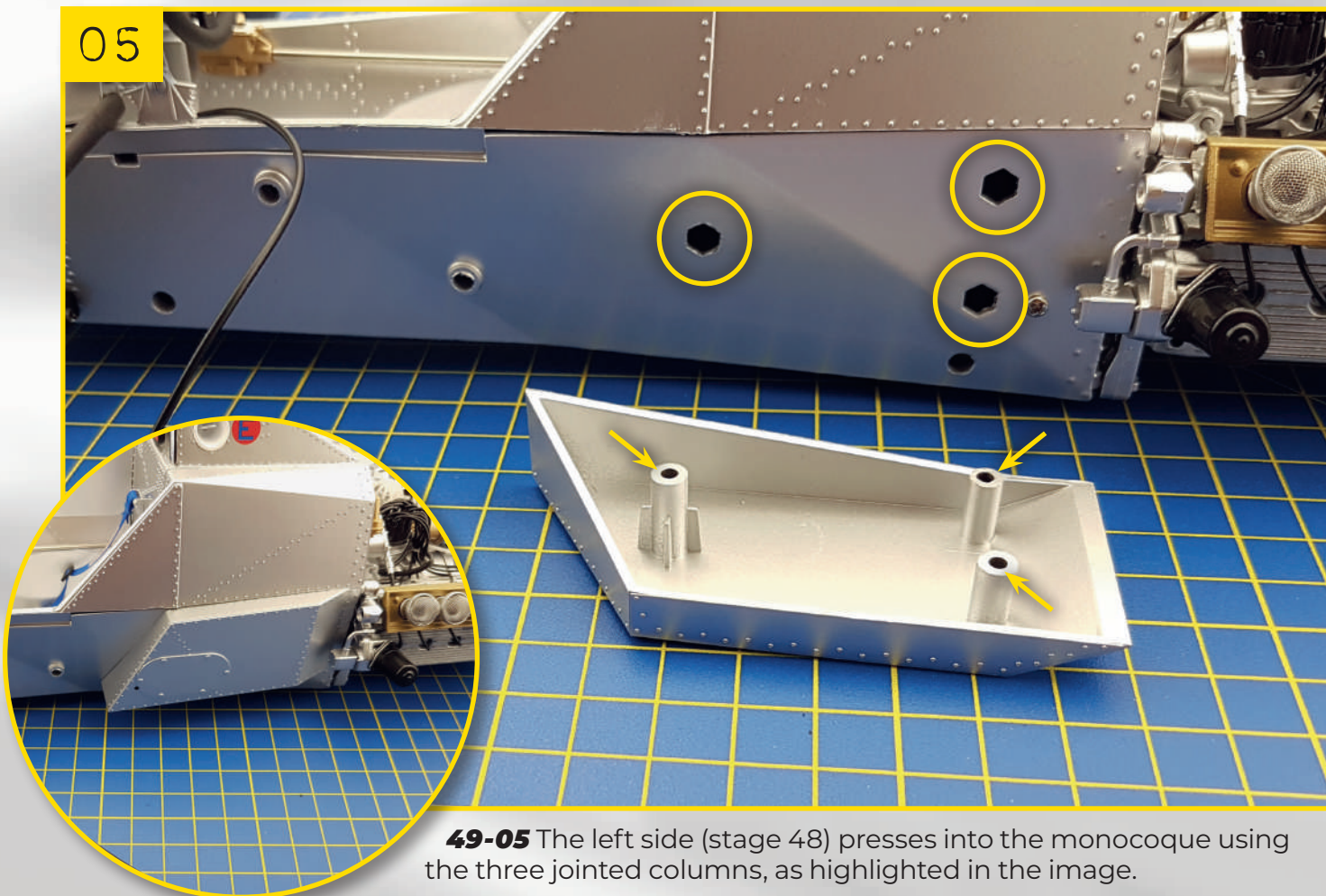

**49-05** The left side (stage 48) presses into the monocoque using the three jointed columns, as highlighted in the image.



06

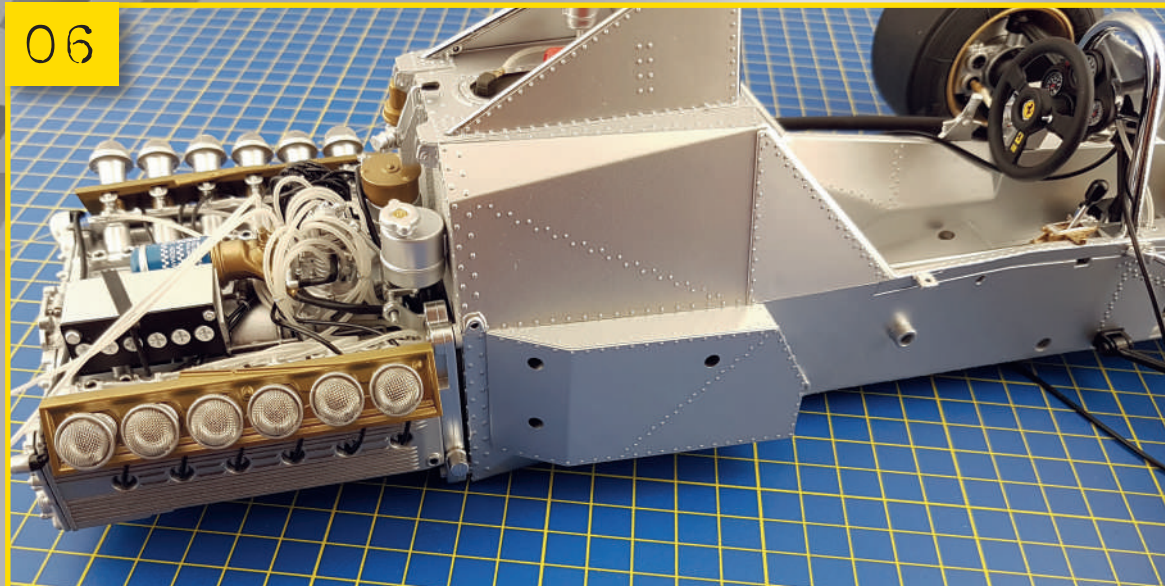

**49-06** Follow the same steps again to fit the right side onto the model.

### FINAL RESULT

You have now joined the engine and cockpit. Your 1:8 scale Ferrari 312 T4 is starting to take shape!

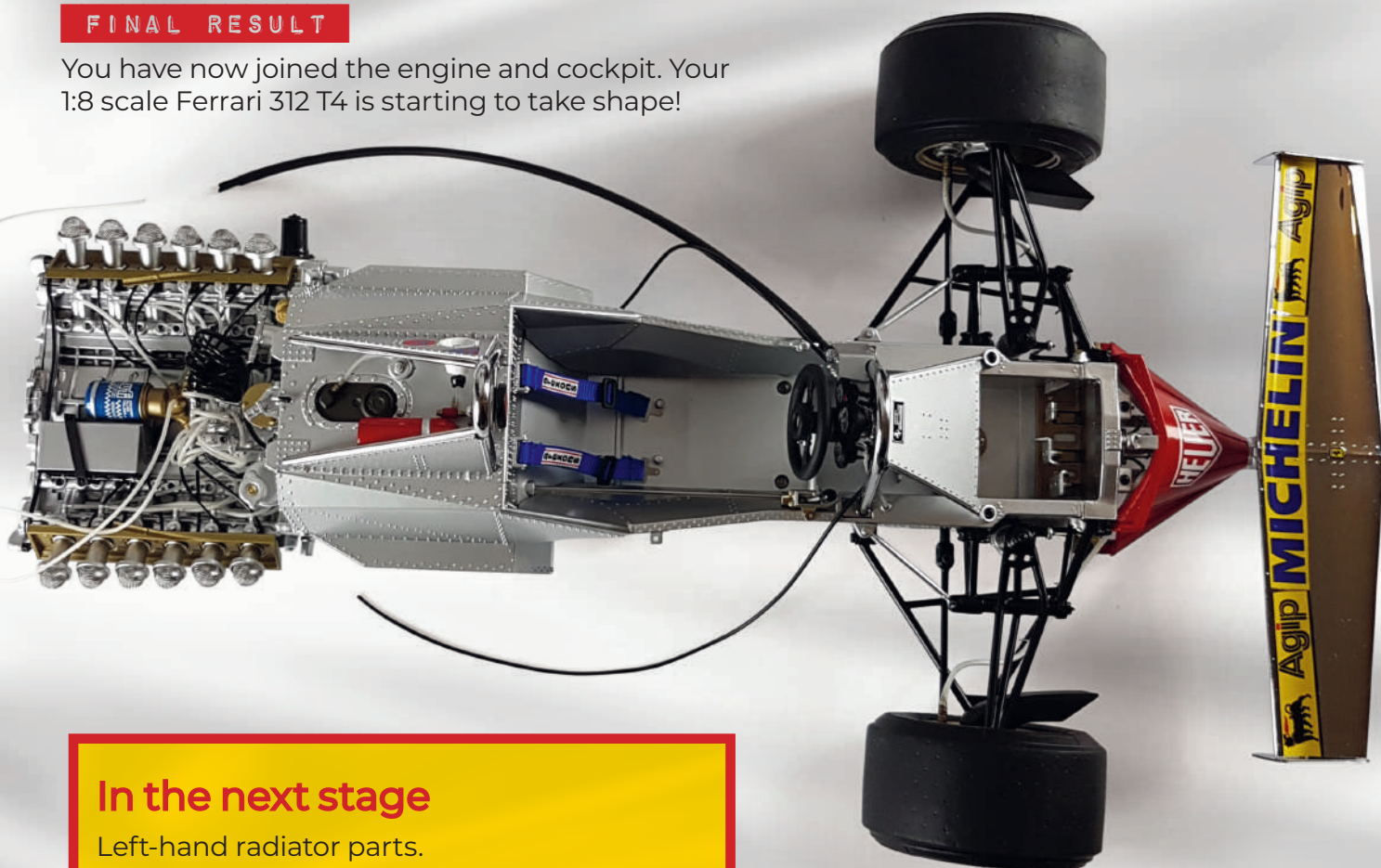

### In the next stage

Left-hand radiator parts.





# LEFT-HAND RADIATOR PARTS

DURING THE ASSEMBLY PROCESS ILLUSTRATED ON THESE PAGES, YOU WILL BE FITTING THE DRIVER'S SEAT IN THE MONOCOQUE. FOLLOW OUR INSTRUCTIONS AND THE ACCOMPANYING IMAGES.



## LIST OF PARTS

- 1 Left radiator main body
- 2 Rear support with fitting
- 3 Front support
- 4 Radiator grille
- 5 Nozzle



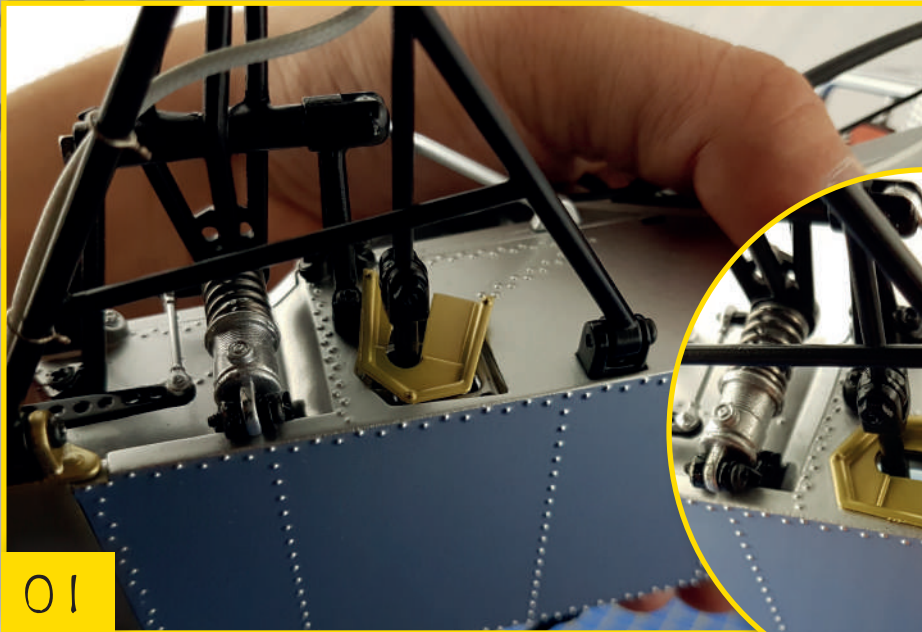

**50-01** Take the cover plates for the left drag link. An “L” printed on the parts makes it easier to identify them. Insert part A upwards from the bottom, then turn it and then press it into place with your fingers until its position is correct.

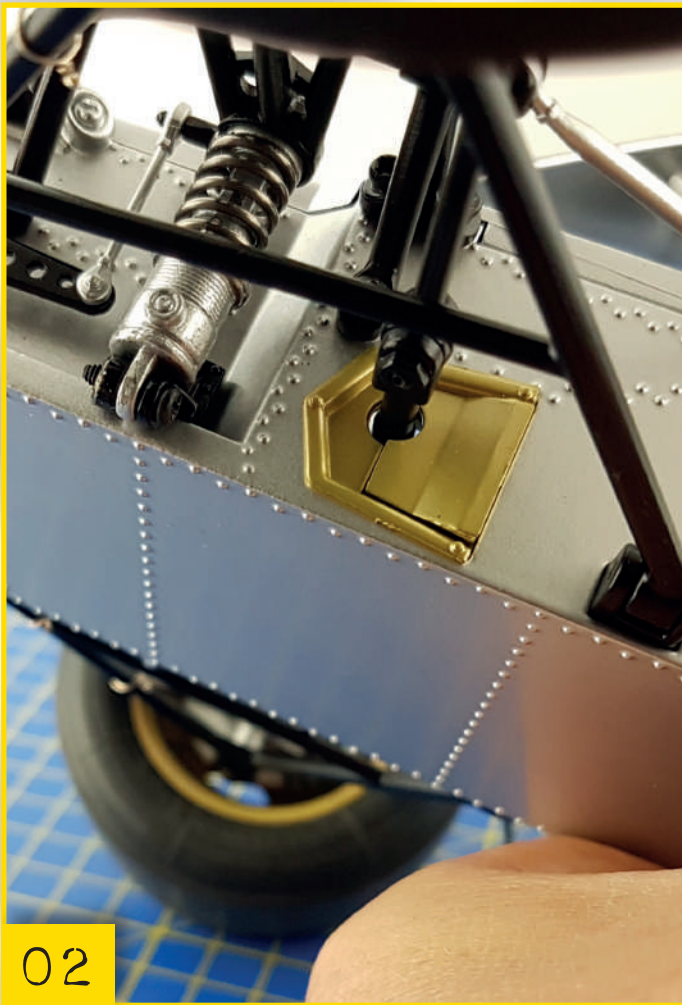
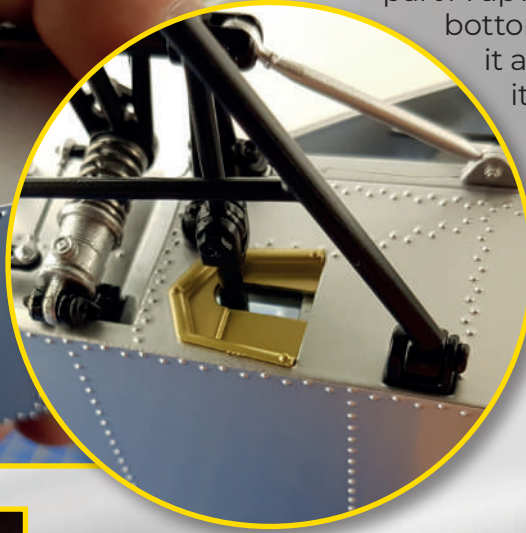

**50-02** Fit part B onto part A, as shown in the image.

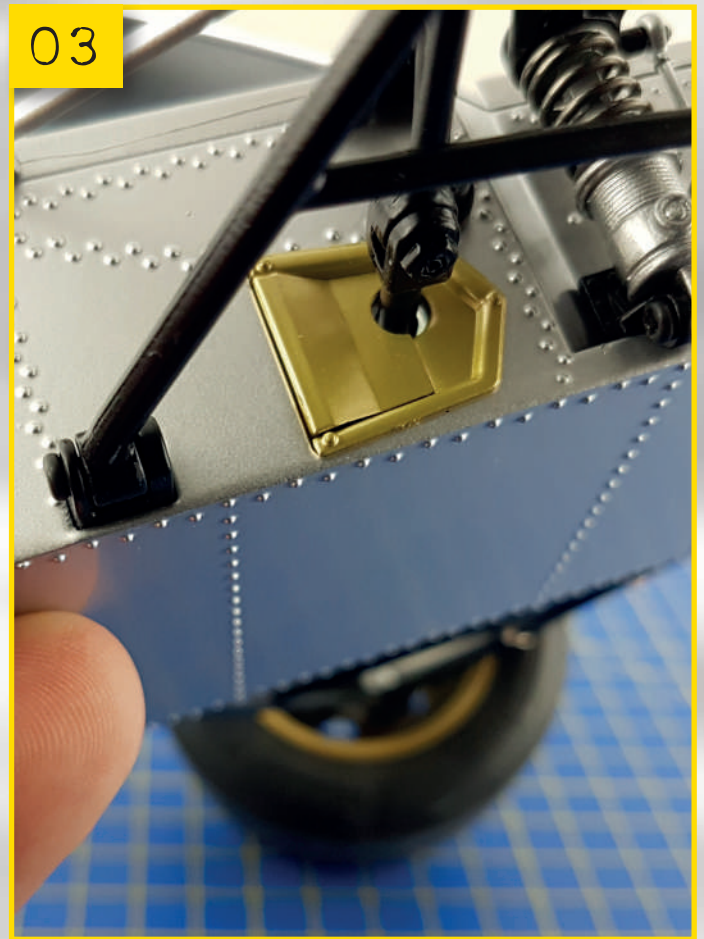

**50-03** Complete the same steps on the other side of the model, this time using the cover plate for the drag link on the right side (letter “R” printed on the parts).





**50-04** Take the seat and pass the seatbelt through its openings, as shown in the image.

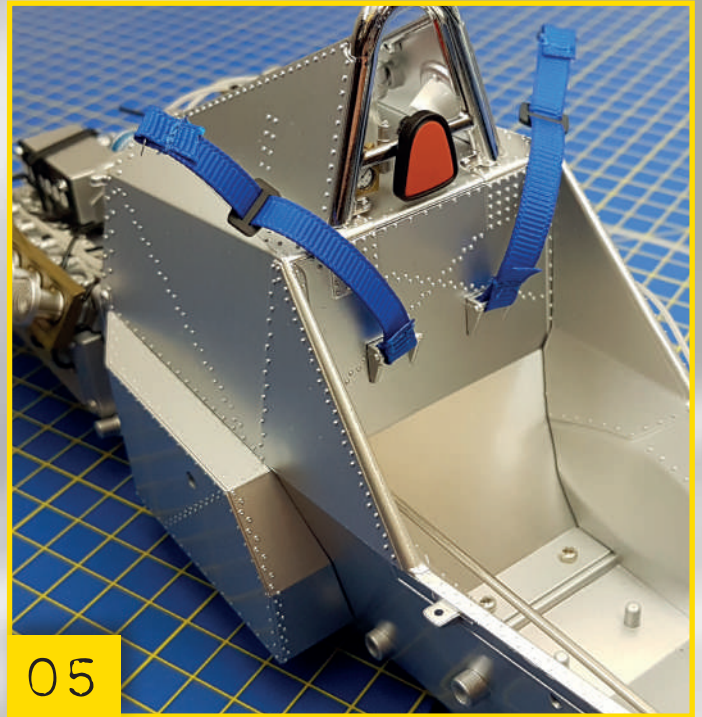

**50-05** Lift the belts in the monocoque.

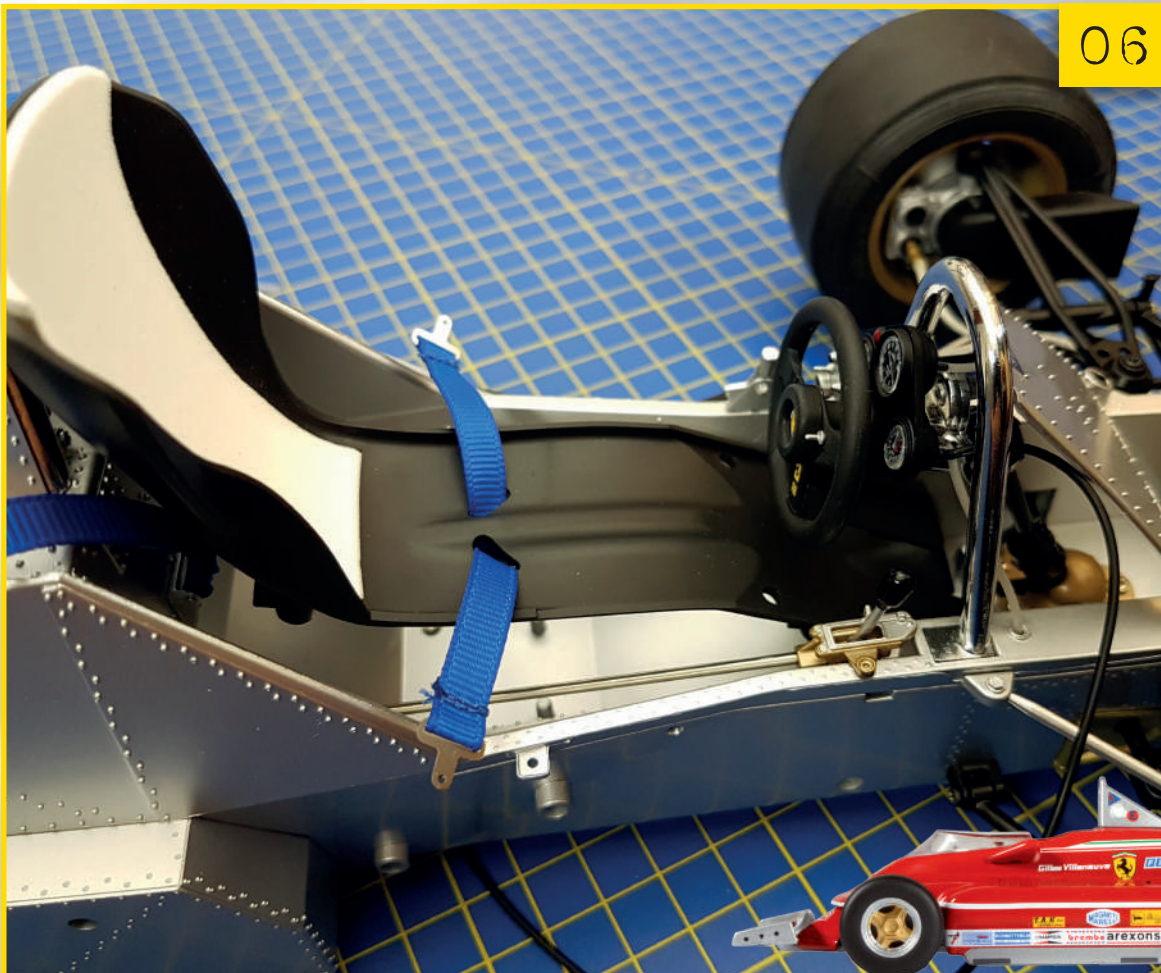

**50-06** You can now fit the seat on board the model.





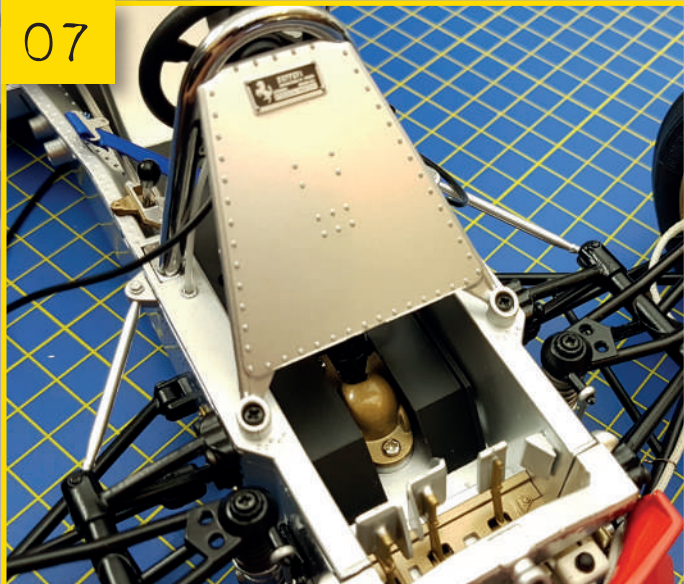

07

**50-07** There are two appendages on the front of the seat, which must be placed to the sides of the steering column plate.

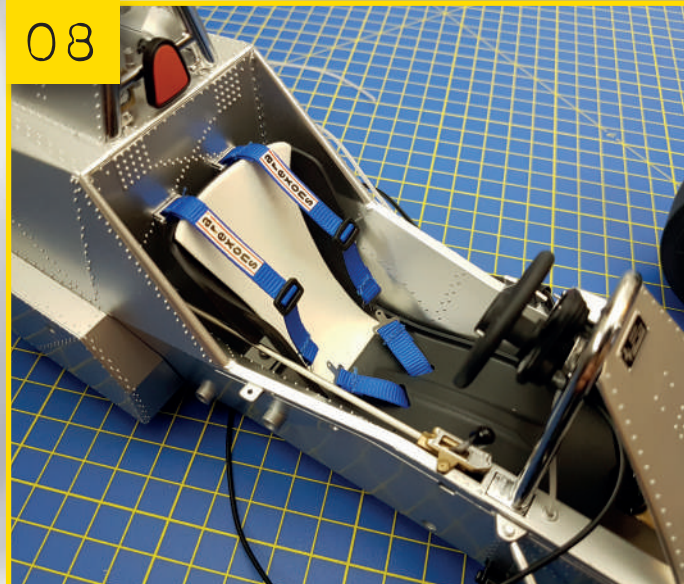

08

**50-08** The seat has two front fixing points and two in the rear. Press down on the front of the seat, and also close to the central seat belt, so that the fixing pins are correctly inserted.

#### FINAL RESULT

Now you have fitted the seat inside the cockpit. Place the model in a safe place, together with the other pieces, ready for the next assembly stages.



#### In the next stage

Right-hand radiator parts.

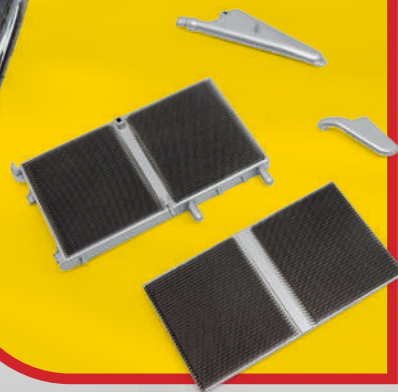



# RIGHT-HAND RADIATOR PARTS

THE STEPS FOR THIS STAGE DO NOT INVOLVE THE PARTS PROVIDED, STORE THEM AWAY FOR NOW. INSTEAD, YOU'LL CONTINUE TO WORK ON THE COCKPIT USING PARTS PROVIDED IN PREVIOUS STAGES.

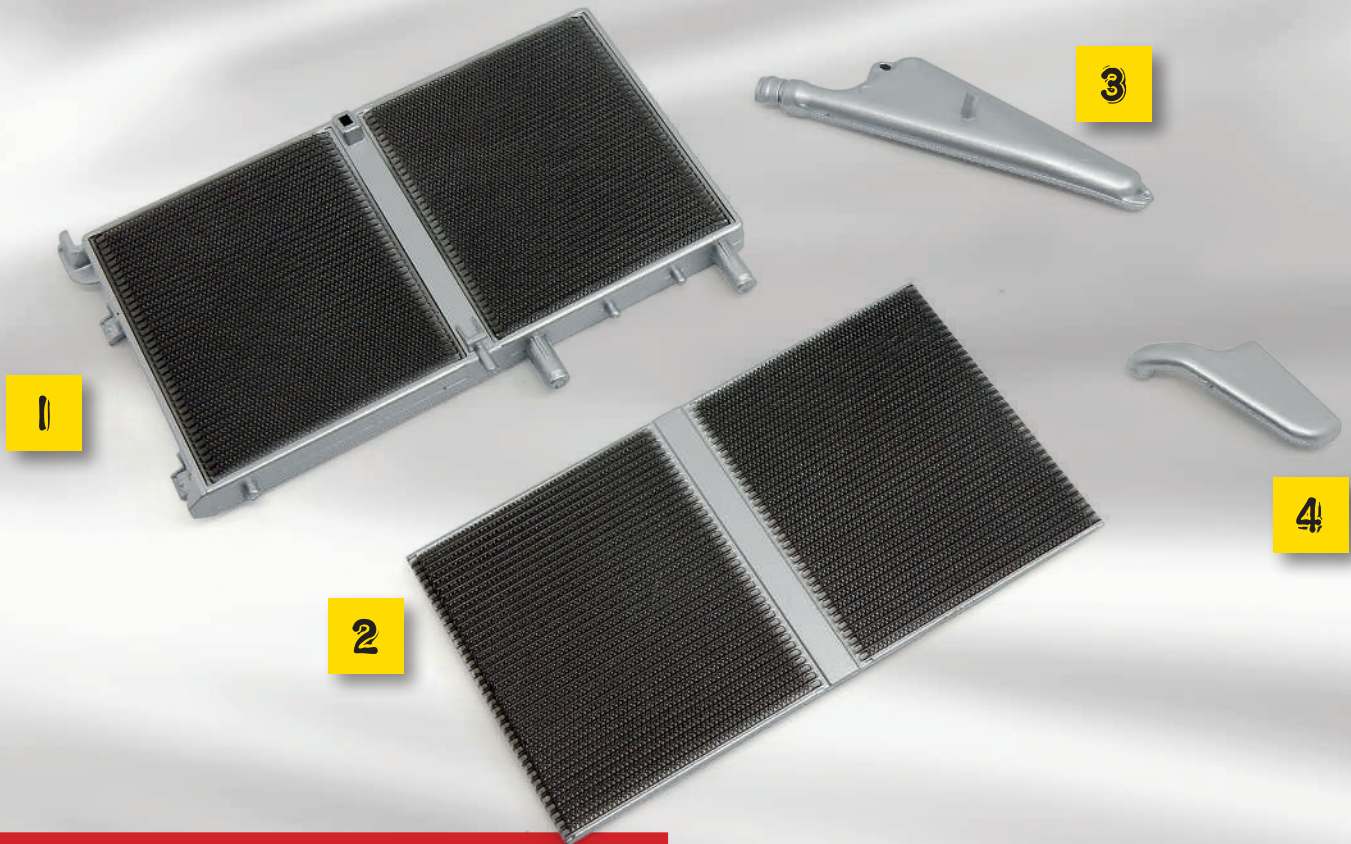

## LIST OF PARTS

- 1 Right radiator main body
- 2 Radiator grille
- 3 Front fitting
- 4 Rear fitting





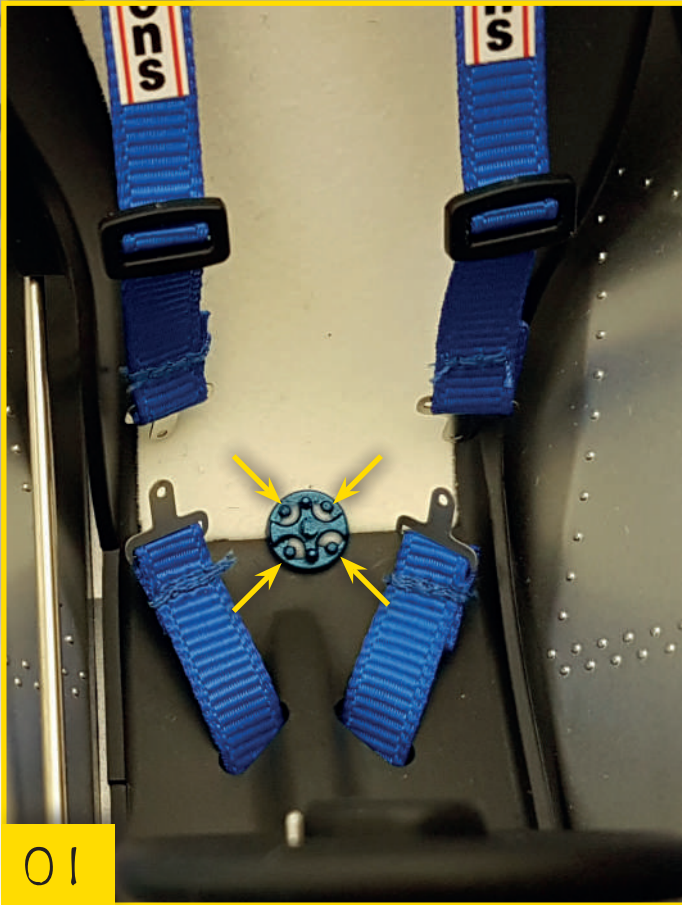

01

**51-01** Place the bottom part of the main buckle plate (stage 25), so that it is facing the direction shown in the image. Apply a drop of cyanoacrylate adhesive to each of the four pins shown in the image.



02

**51-02** Fit the buckle of the corresponding belt to each of the pins. Then close the main buckle plate, positioning the top part (also provided in stage 25).

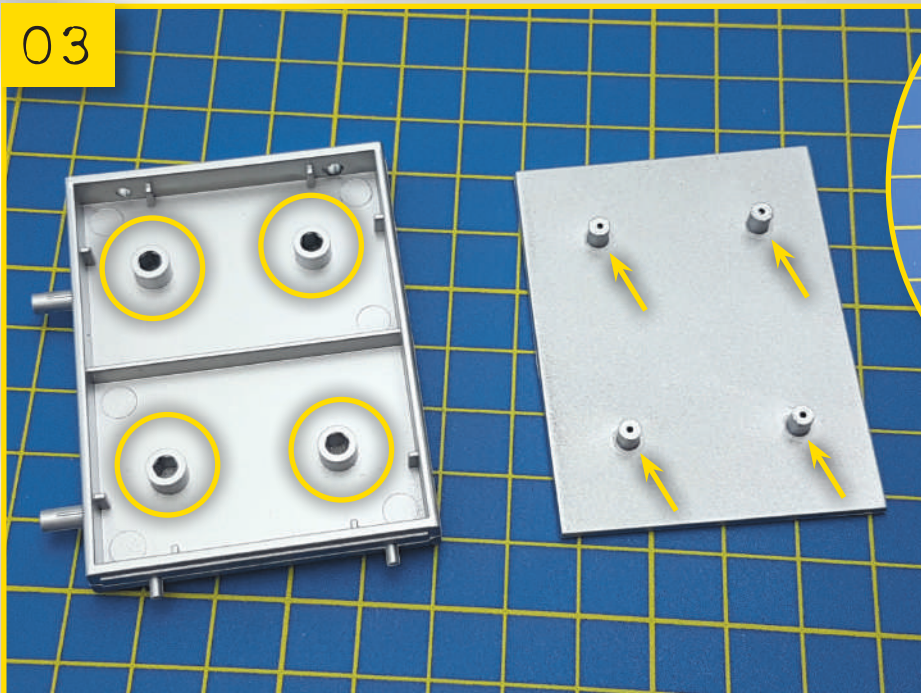

03

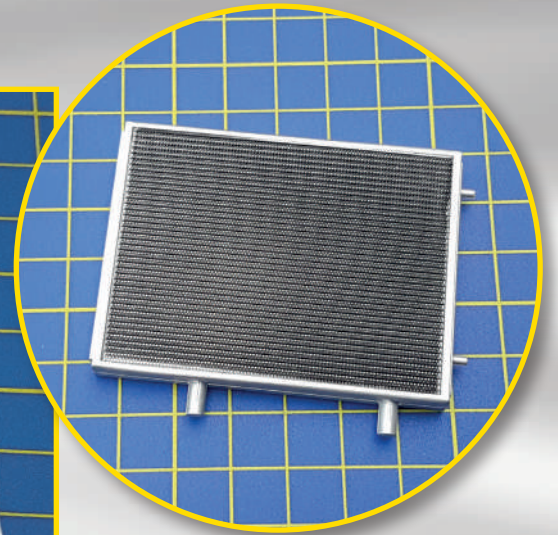

**51-03**

Use the four joint elements to press the grille into the left radiator body. You received these parts in the last stage.



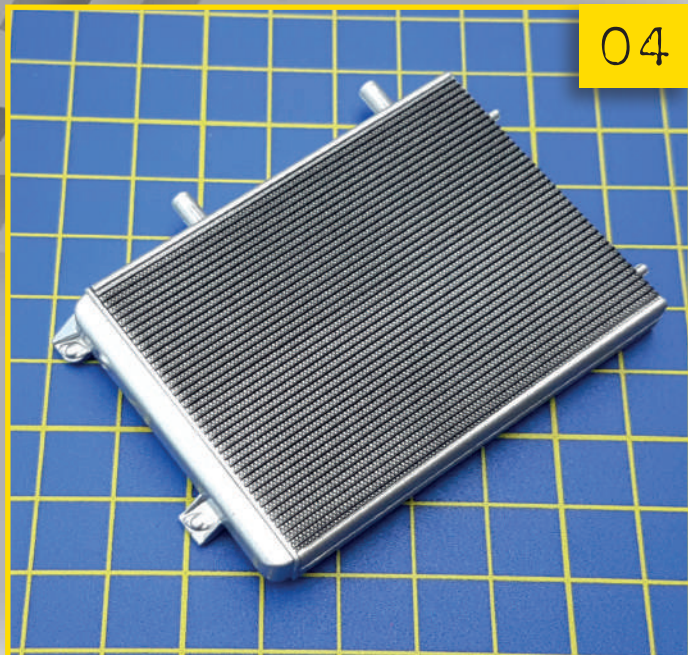

**51-04** Join this to the front support.

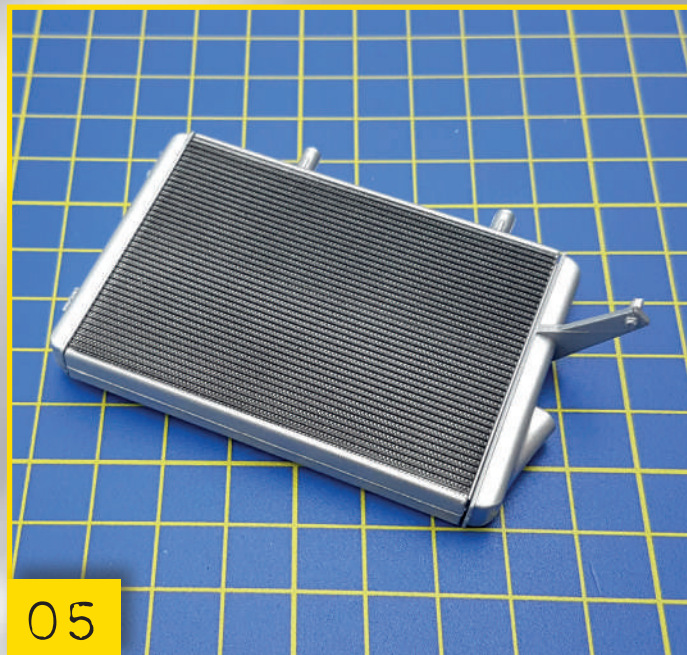

**51-05** Use the joint elements to fit the rear support.

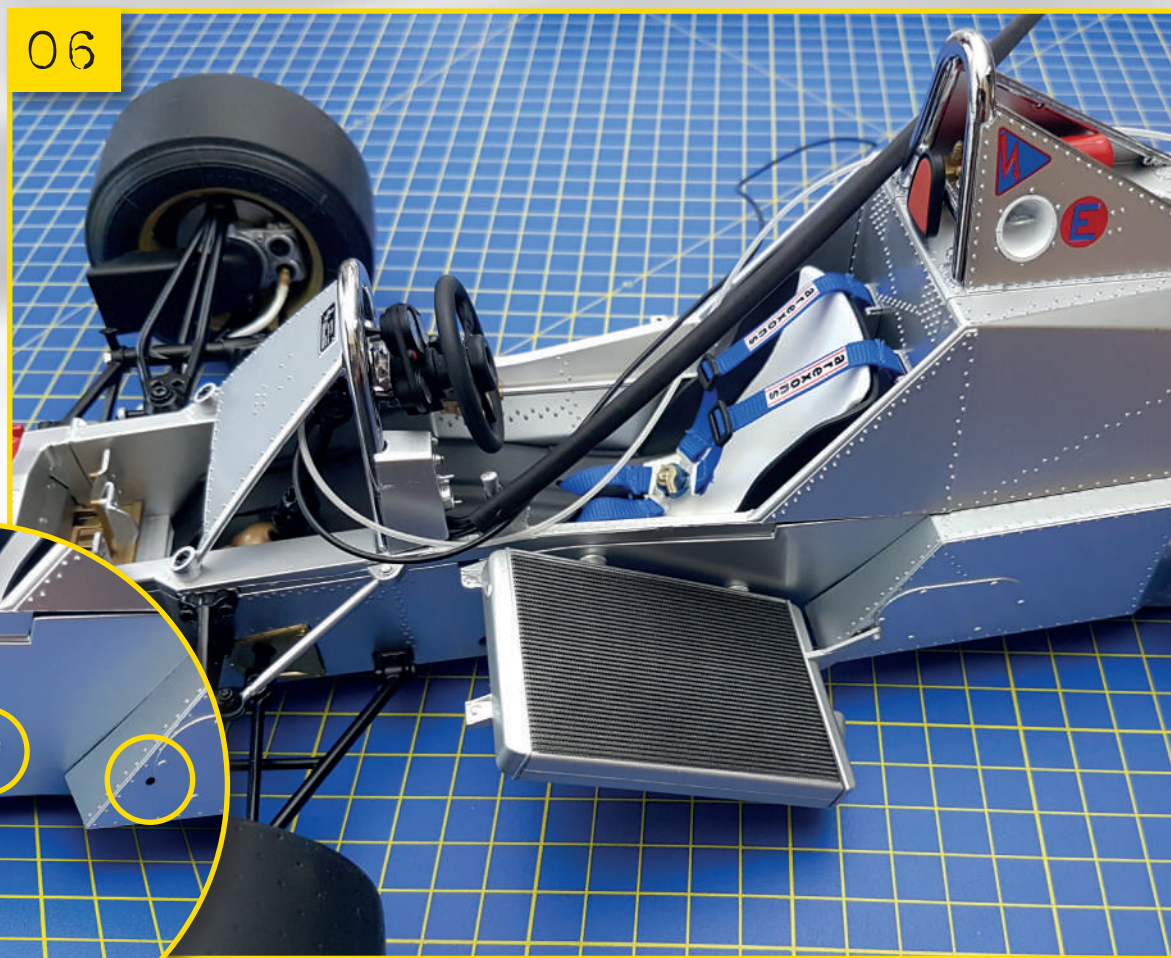

**51-06** Fit the left radiator to the model, inserting the relevant pins into the assembly holes highlighted in the inset image.



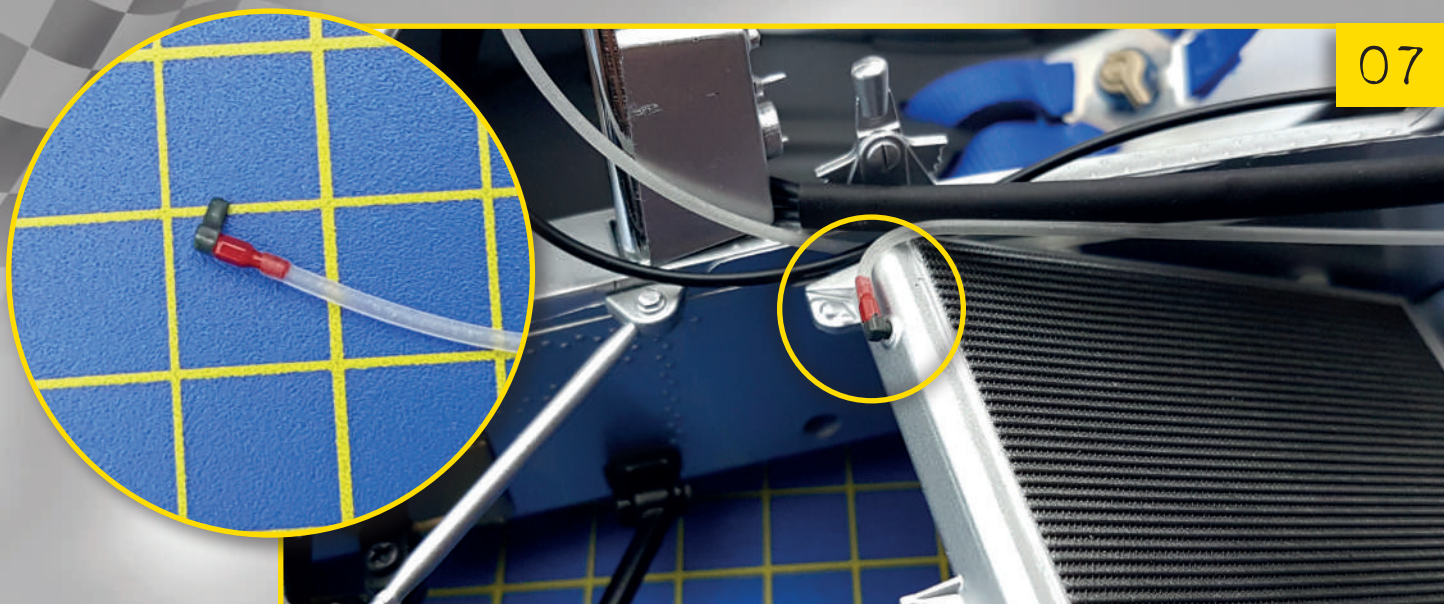

**51-07** After joining it to the pipe, fit the nozzle on the left-hand radiator.

**FINAL RESULT**

Now you have assembled the left radiator and fitted it to your model.



**In the next stage**

The liquid coolant tank and its pipes.

 A yellow rectangular box containing the parts for the next stage of assembly. It includes a silver liquid coolant tank with two pipes attached, and a separate silver pipe component.



# COOLANT FLUID TANK

THESE INSTRUCTIONS WILL SHOW YOU HOW TO BUILD AND FIT THE RIGHT-HAND RADIATOR TO YOUR MODEL, USING THE PARTS FROM THE PREVIOUS STAGE. THE PARTS FROM THIS STAGE WILL BE USED IN THE FUTURE, SO KEEP THEM SAFELY ASIDE FOR NOW.

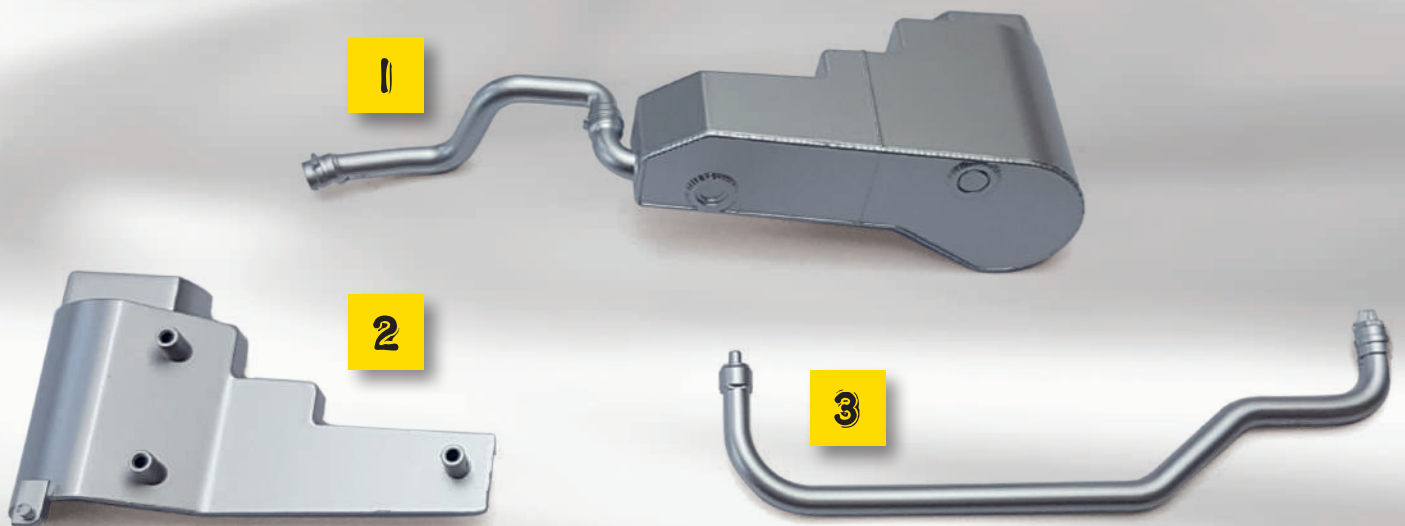

## LIST OF PARTS

- 1 Coolant fluid tank body
- 2 Tank body cover
- 3 Pipe 1





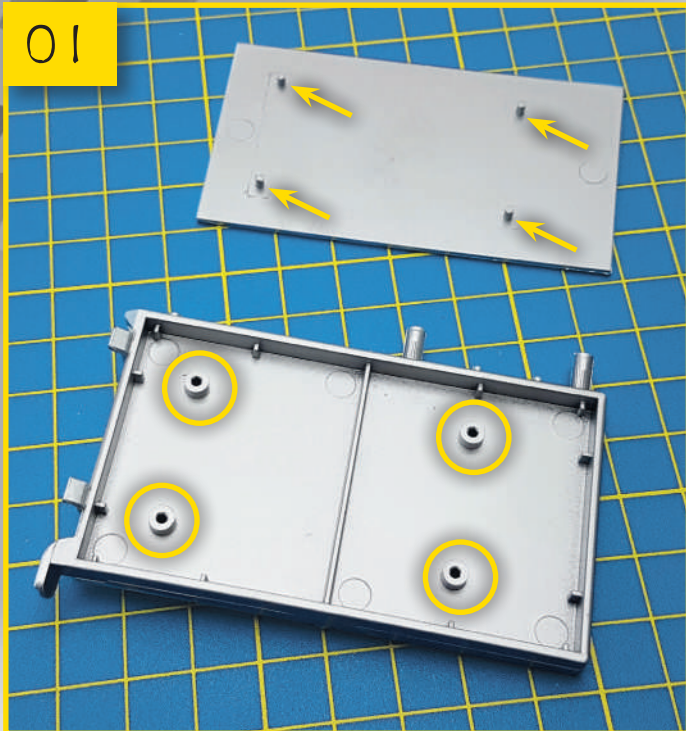

**52-01** Take the radiator body and its grille from the parts provided with stage 51. Set the parts out on your work surface as they are in the image, in order to identify the joint structures.

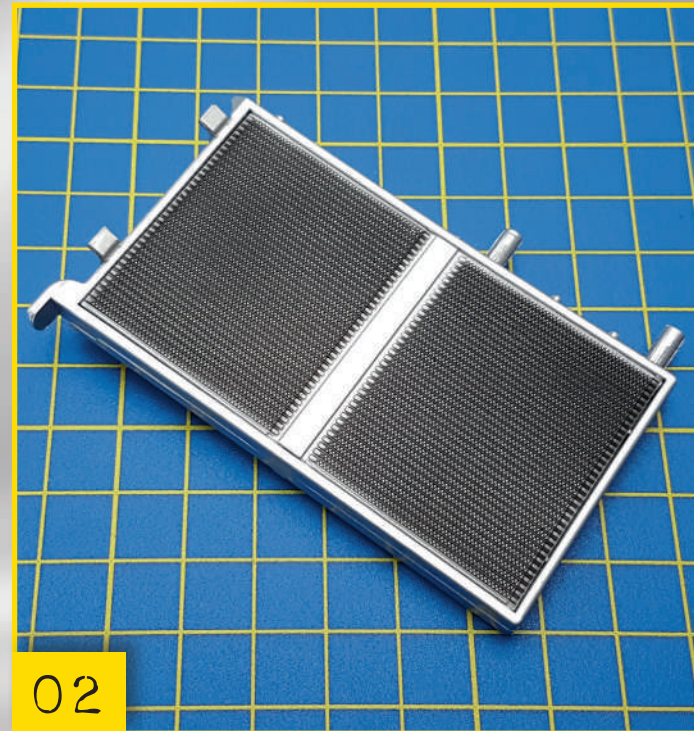

**52-02** Use the pins and holes highlighted in the previous step and press the right radiator onto its grille.

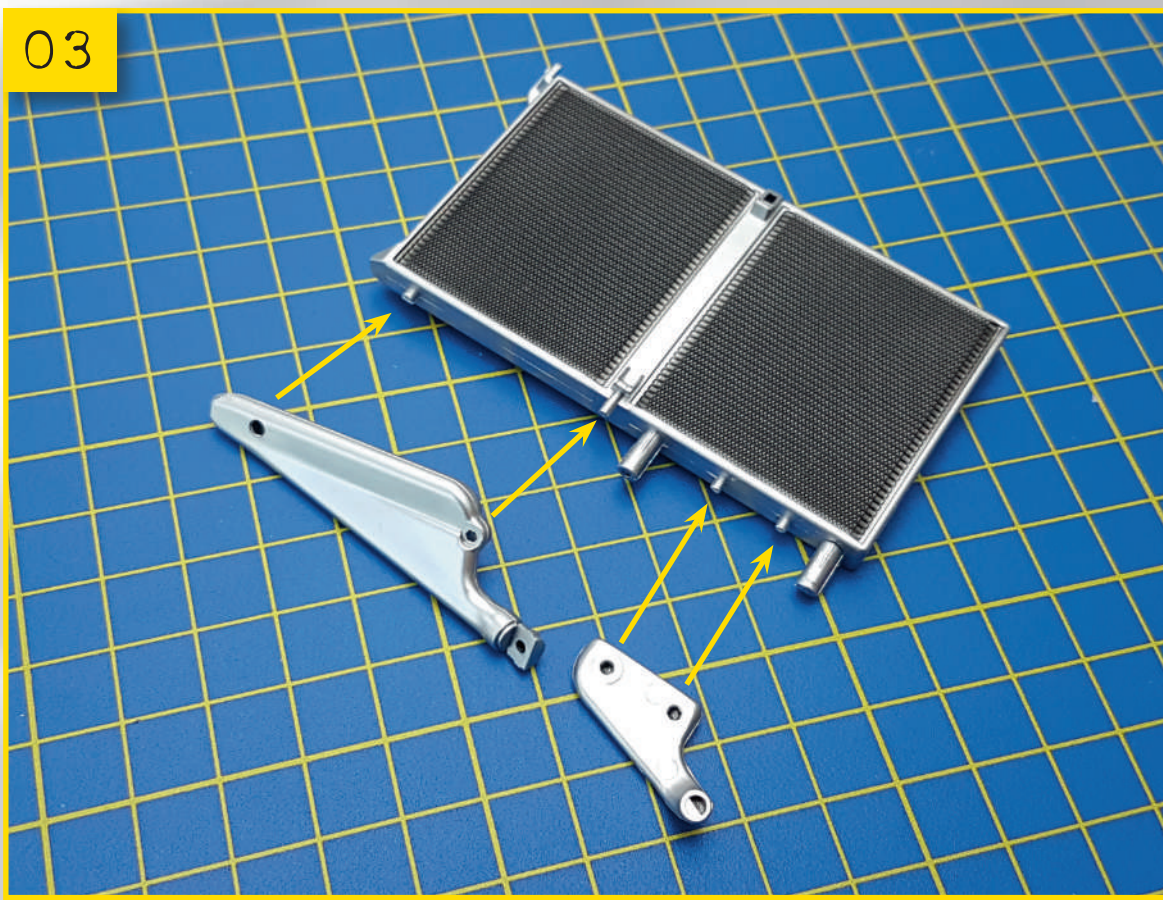

**52-03** Take the two fittings and set them out on your work surface, aligning them with the right radiator as shown..



04

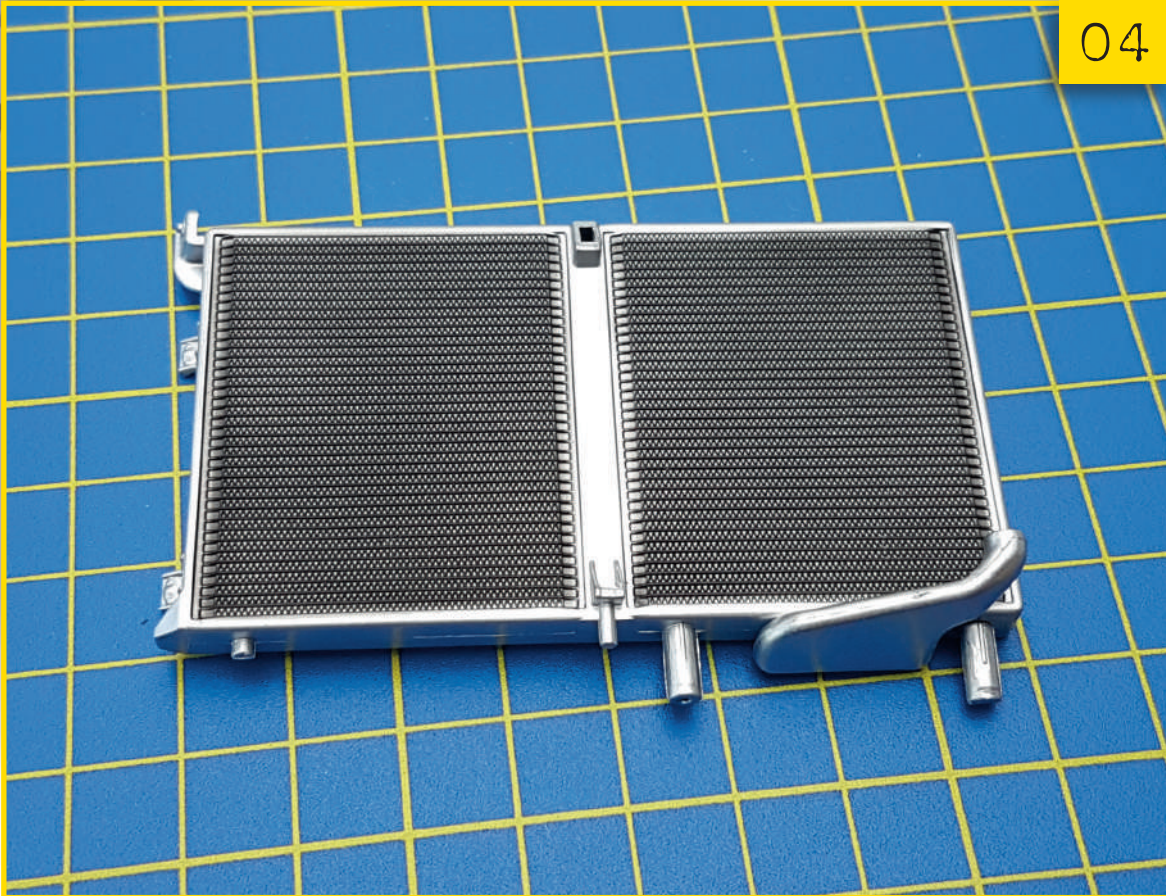

**52-04** Press the rear fitting onto the pins of the right radiator assembly highlighted in the previous step.

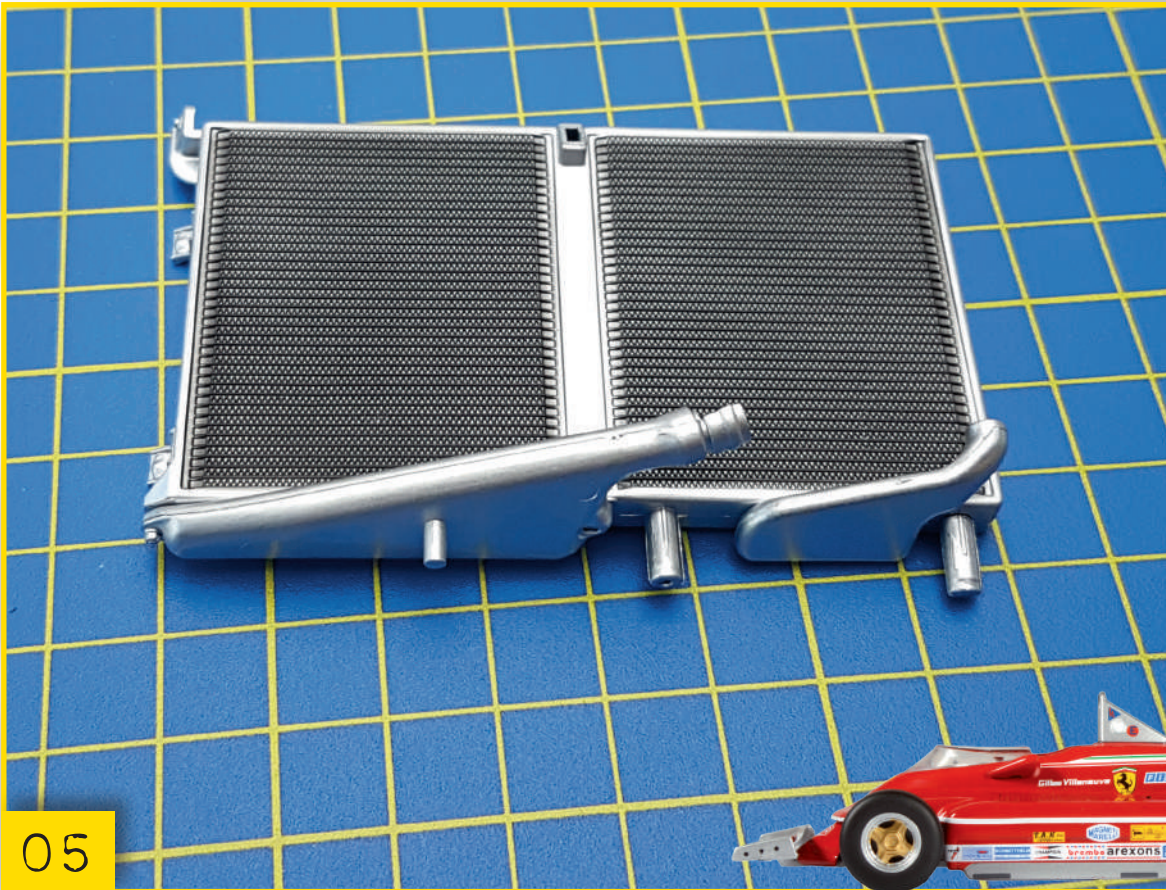

**52-05** Press the front fitting onto the radiator assembly in the same way.

05





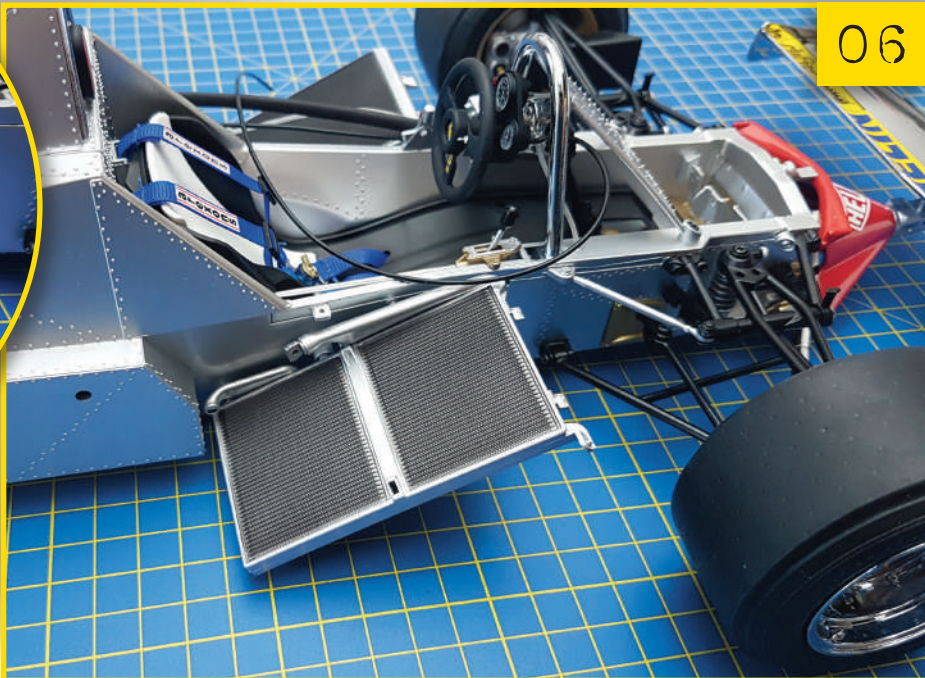
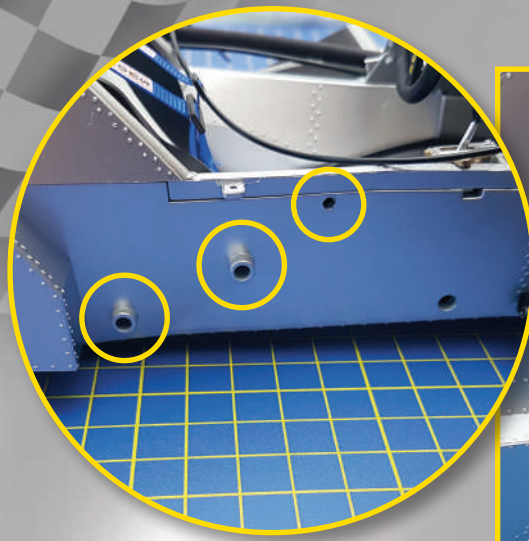

**52-06** Fit the right radiator to the model, inserting the relevant pins into the assembly holes highlighted in the inset image.

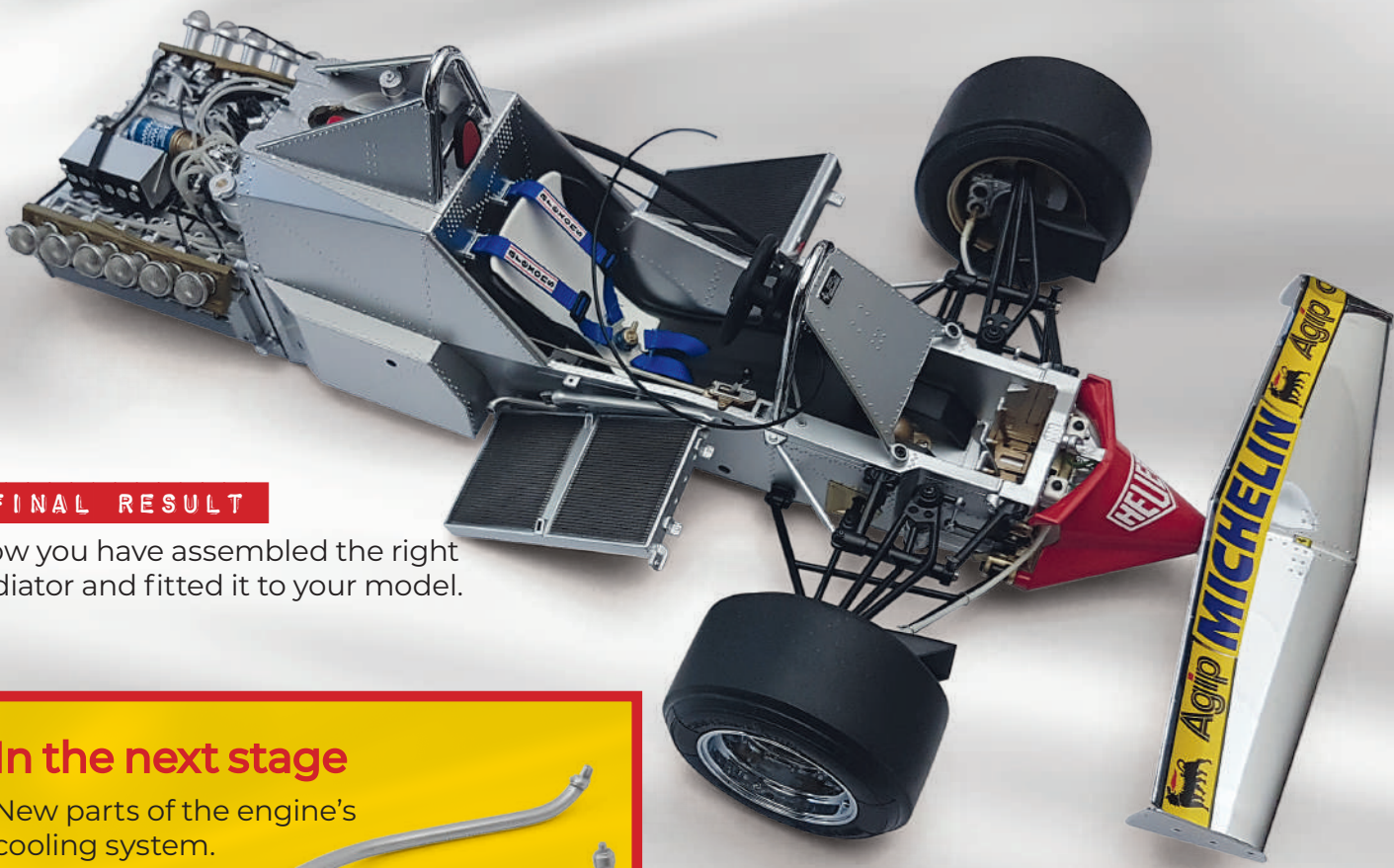

**FINAL RESULT**

Now you have assembled the right radiator and fitted it to your model.

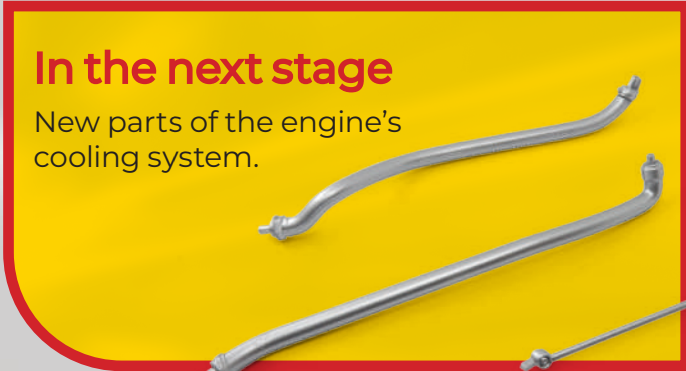

**In the next stage**  
New parts of the engine's cooling system.