



Lamborghini MIURA



Pack 10

BUILD INSTRUCTIONS

STAGE 75: INSTALLING THE FUEL PUMPS AND THE FRONT FRAME REINFORCEMENT PLATES

STAGE 76: FITTING THE DASHBOARD AND FRONT FRAME INTO THE BODY AND INSTALLING THE CIRCUIT BOARD

STAGE 77: CONNECTING THE WIRING AND FITTING THE COCKPIT INTO THE BODY

STAGE 78: FITTING THE REAR FRAME AND INSTALLING THE UPPER TIE RODS

STAGE 79: ATTACHING THE LEFT AND RIGHT DOORS

STAGE 80: BUILDING THE BONNET REINFORCEMENT STRUCTURE (1)

STAGE 81: BUILDING THE BONNET REINFORCEMENT STRUCTURE (2)

STAGE 82: ASSEMBLING THE HEADLIGHTS

The "Automobili Lamborghini" and "Automobili Lamborghini Bull and Shield" trademarks, copyrights, designs and models are used under license from Automobili Lamborghini S.p.A, Italy.

AGORA
MODELS®

Advice from the experts

Spare screws are included with each part. Occasionally, you may be instructed to keep spare or unused screws for a later stage. Keep these spares in a safe place and label them correctly.

Please make sure you don't mix up the screws. They look quite similar, but the threads do vary slightly. Using the wrong screws may damage the parts.

When securing parts together using multiple screws, fit each screw loosely to ensure all the parts are correctly aligned before gently tightening them firmly, but not overtight, in the order in which you placed them.

The screwdriver can be magnetized by stroking it with a magnet (fridge magnet, etc.) enabling it to hold the screws and make assembly easier.

If a screw is tight going into a metal part, do not force it as you may shear the head off. Remove it and put a tiny smear of Vaseline, soap or light oil on the thread. That will lubricate it and make it easier to drive home.

During the course of this build, you will receive many pieces that you will assemble immediately – following the instructions in the corresponding stage – and other pieces that you should store safely to one side, for use in future assembly stages.

Left and Right! When building your Lamborghini, the left or right hand side refers to each side as you are sitting in the car.



WARNING: Some parts are assembled using magnets. These magnets can cause serious injury if they are swallowed. Keep away from children. If you suspect a magnet has been swallowed, seek medical help straight away.

Stage 75: Installing the Fuel Pumps and the Front Frame Reinforcement Plates

In this stage you'll fit the front reinforcement plates onto the frame, then construct and install the fuel pumps.



STAGE 75 PARTS LIST

Name
Fuel pump (1)
Fuel pump bracket
Fuel pump (2)
Front frame reinforcement plate (right)
Fitting x2
Front frame reinforcement plate (left)
Long tube x2
Short tube x4

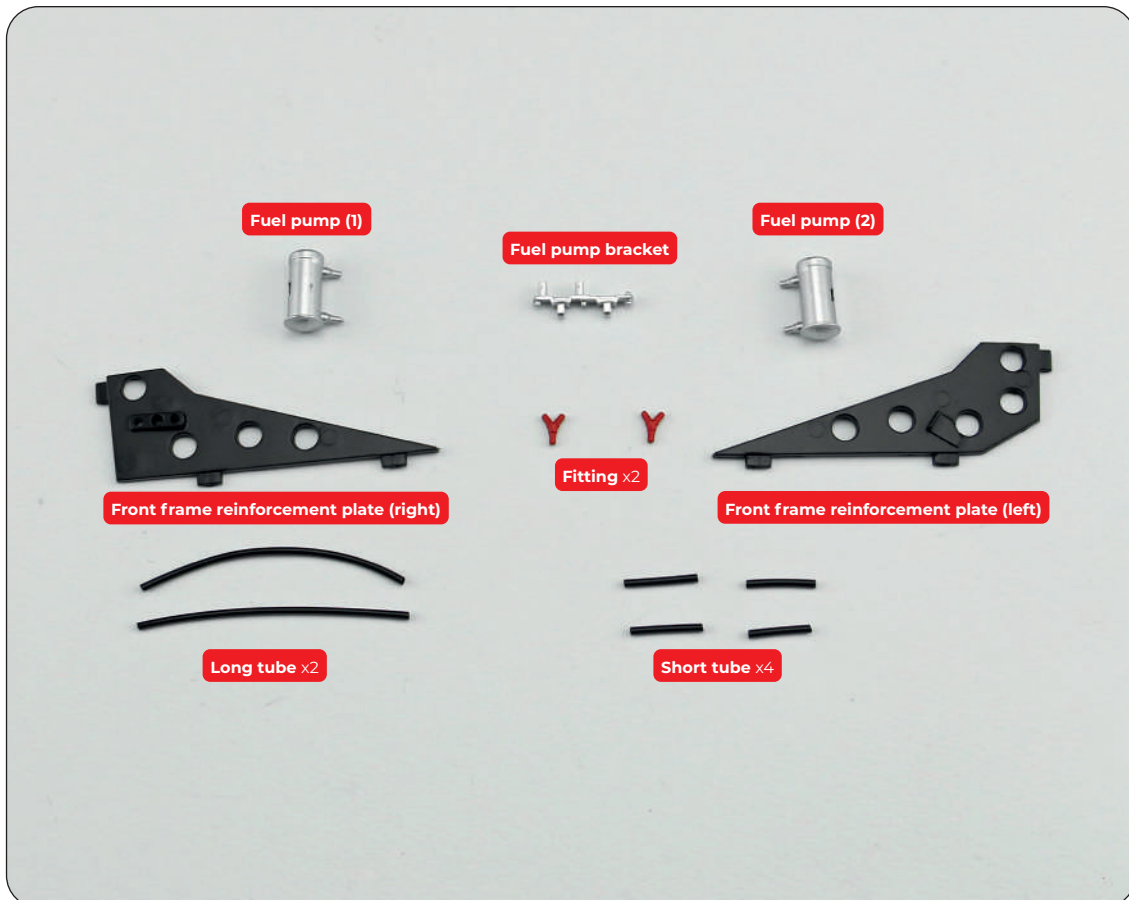

Stage 75: Installing the Fuel Pumps and the Front Frame Reinforcement Plates

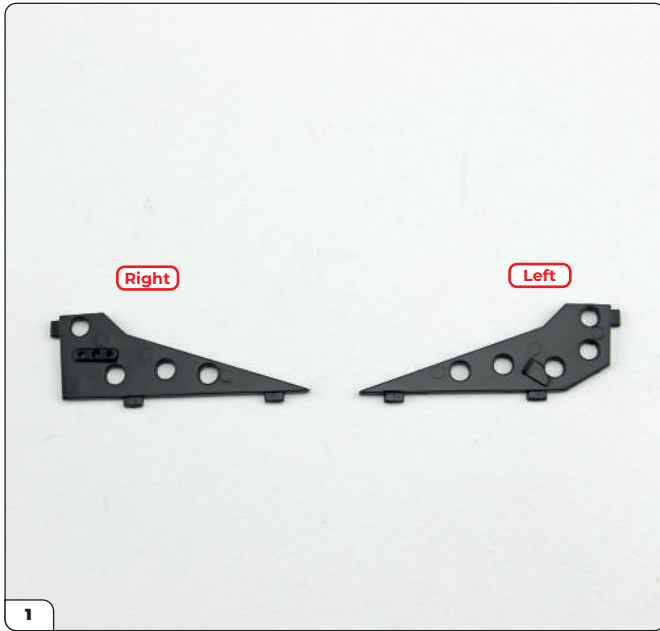

Take the two front frame reinforcement plates and lay them on your work surface as shown. To distinguish the left plate from the right, note the number of holes – the right one has four, the left one has five.

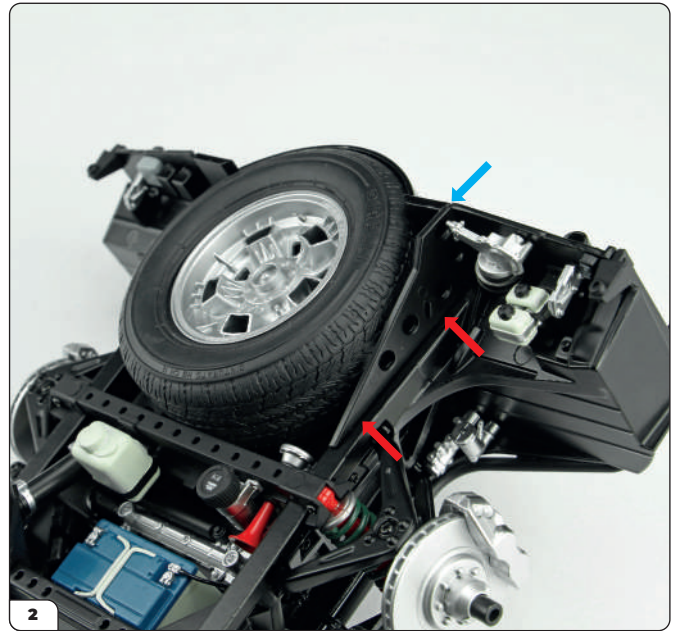

Take the front frame assembly. On the left-hand side, next to the spare wheel, there are two rectangular holes (red arrows) as well as a small break (blue arrow) in the frame: these are the three fixing points for the left reinforcement plate. Insert the plate into position by fitting the three plugs of the piece into the fixing points of the frame. We recommend starting with fitting the plate into the small break first, then pressing it into the rectangular holes.

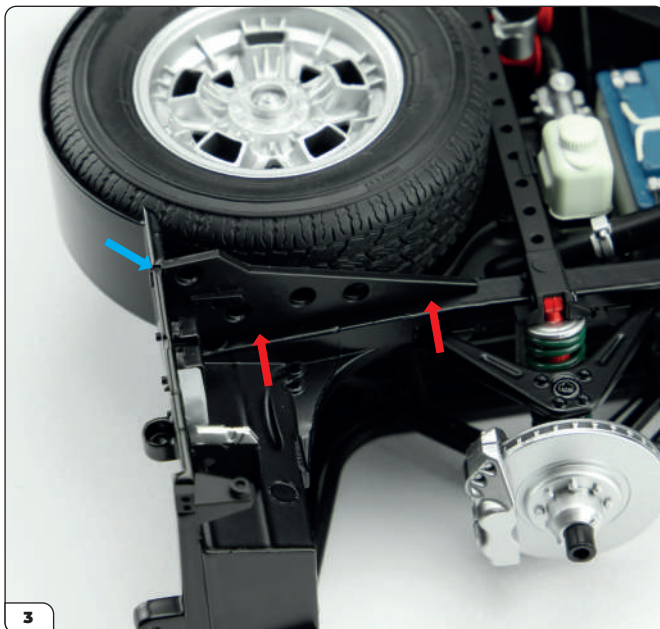

Repeat on the other side of the frame to fit the right reinforcement plate in place.

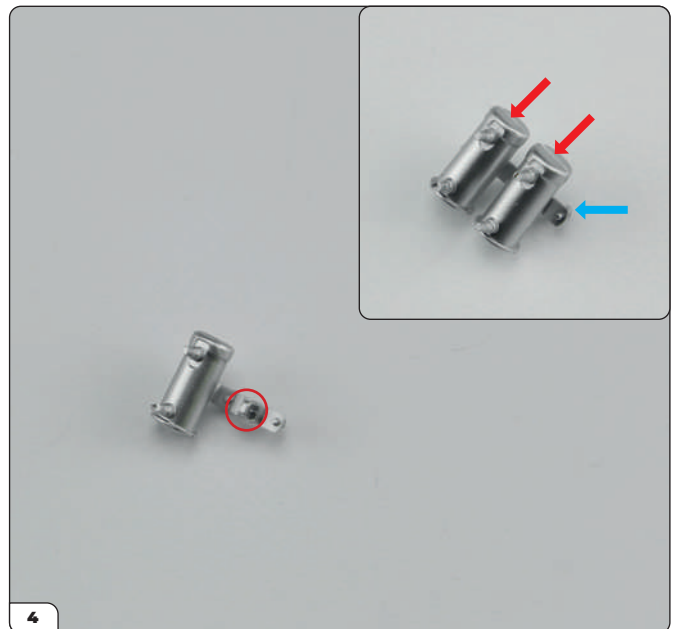

Take one of the fuel pumps and the fuel pump bracket. Press the pump into the bracket, by inserting the rectangular pins of the bracket (circled) into the hole of the pump. Fit the second fuel pump in the same manner. Ensure that the parts are oriented as shown in the inset photo, with the pins on the back of the bracket (blue arrow) on the right while the flat ends of the fuel pumps (red arrows) are oriented upwards.

Stage 75: Installing the Fuel Pumps and the Front Frame Reinforcement Plates

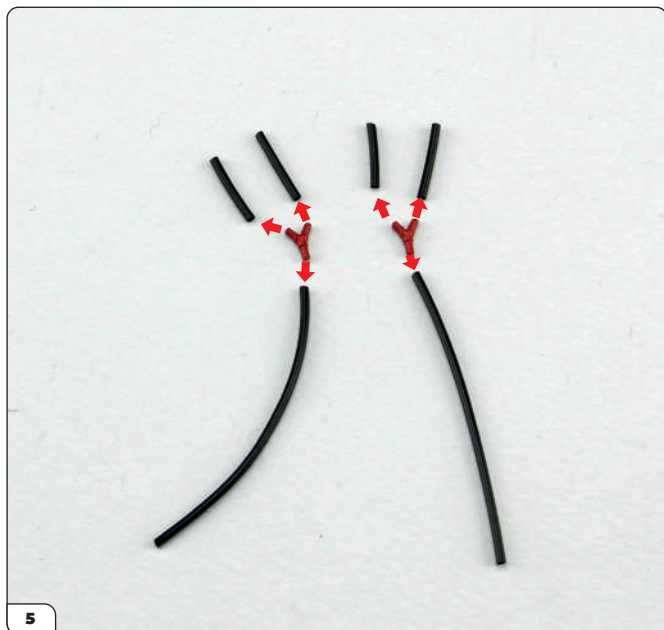

Next take the two fittings along with the long and short tubes and lay them on your work surface oriented as shown. Fit the long tubes onto the ends of the Y-shaped fittings and the short tubes onto the split branches of the fittings (red arrows).



To get a good fit, try twisting the tubes between your thumb and finger as you press them onto the fitting.

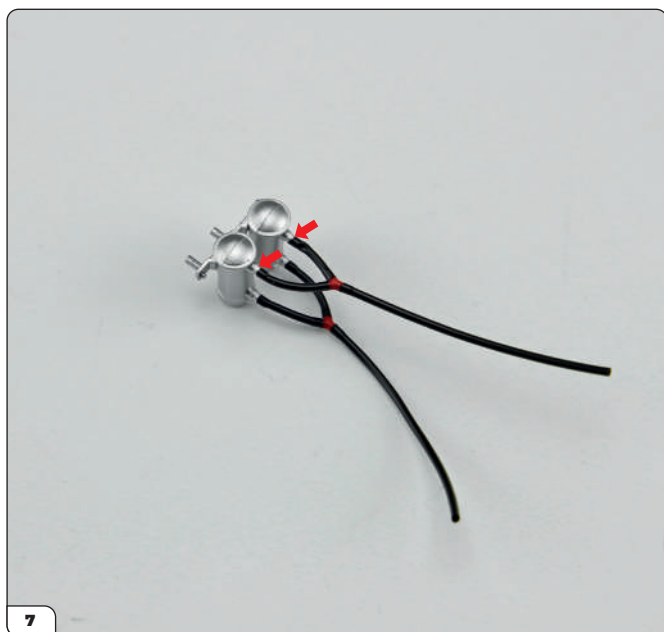

Push one pair of the short tubes onto the top pins of the fuel pumps (red arrows). The other pair fits onto the bottom pins as shown.

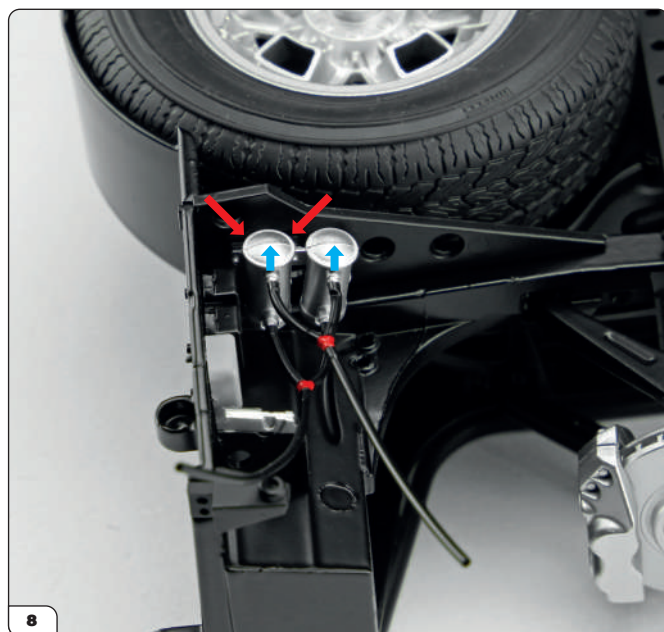

You can now mount the fuel pump bracket onto the right-hand frame reinforcement plate. To do this, insert the pins of the pump bracket into the two holes on the plate (red arrows). Note that the rounded ends (blue arrows) of the fuel pumps are oriented upwards.

Stage 75: Installing the Fuel Pumps and the Front Frame Reinforcement Plates

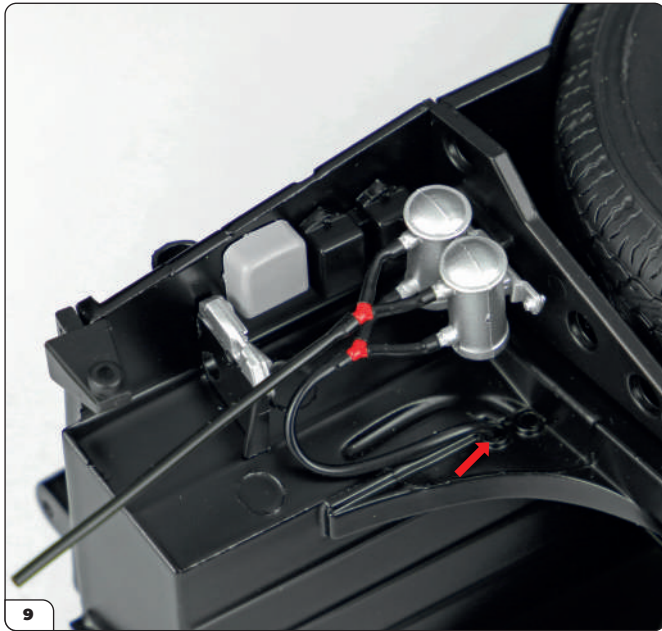

On the frame, below the two pumps, there are two holes into which the ends of the long pipes are inserted. Insert the loose end of the lower long tube into the hole highlighted in the photo with an arrow. You may wish to remove then place the tube in hot water first to bend it into shape.

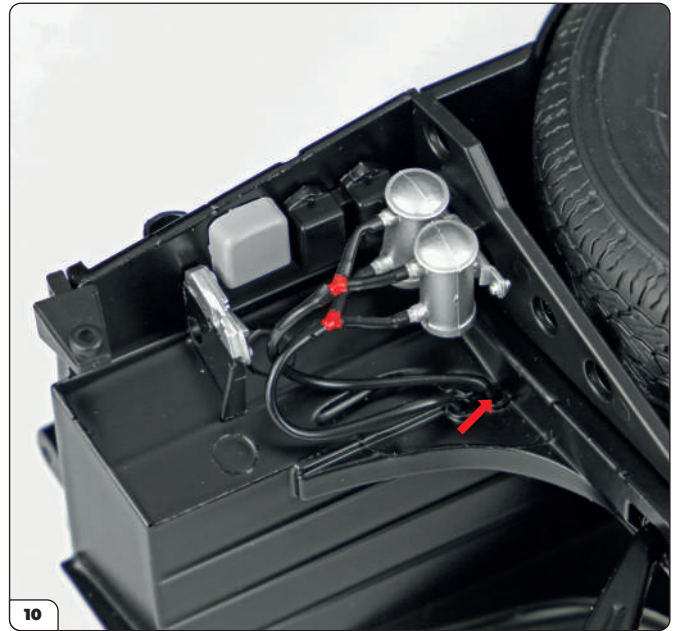

Insert the end of the upper long tube into the other hole as shown.

STAGE COMPLETE

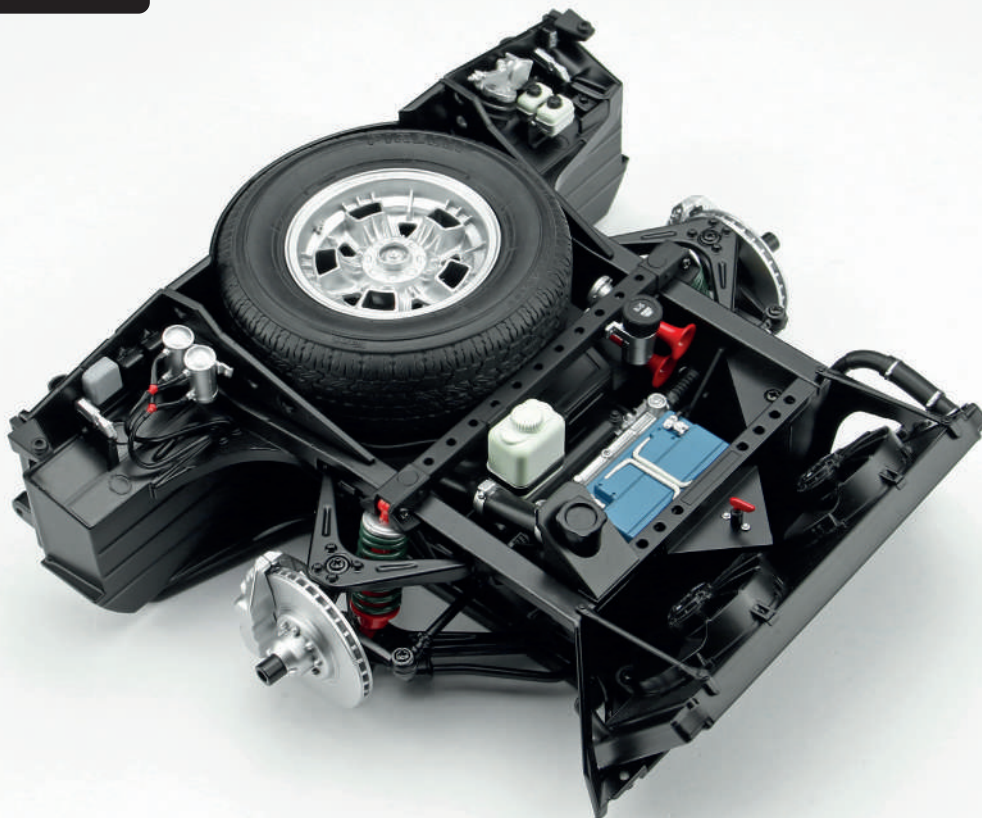

Stage 76: Fitting the Dashboard and Front Frame into the Body and Installing the Circuit Board

You'll need the dashboard and the central body assemblies for this stage. After fitting the dashboard in place, you'll fix the circuit board for the model's electronics. You'll then attach the front frame and body together.

The upper tie rods supplied with this stage can be stored away for now until they are needed later in this Pack.



STAGE 76 PARTS LIST

Name
Upper tie rod x2
Circuit board
Steering joint
Type Q screws x2
Type A screws x15
Type B screws x8

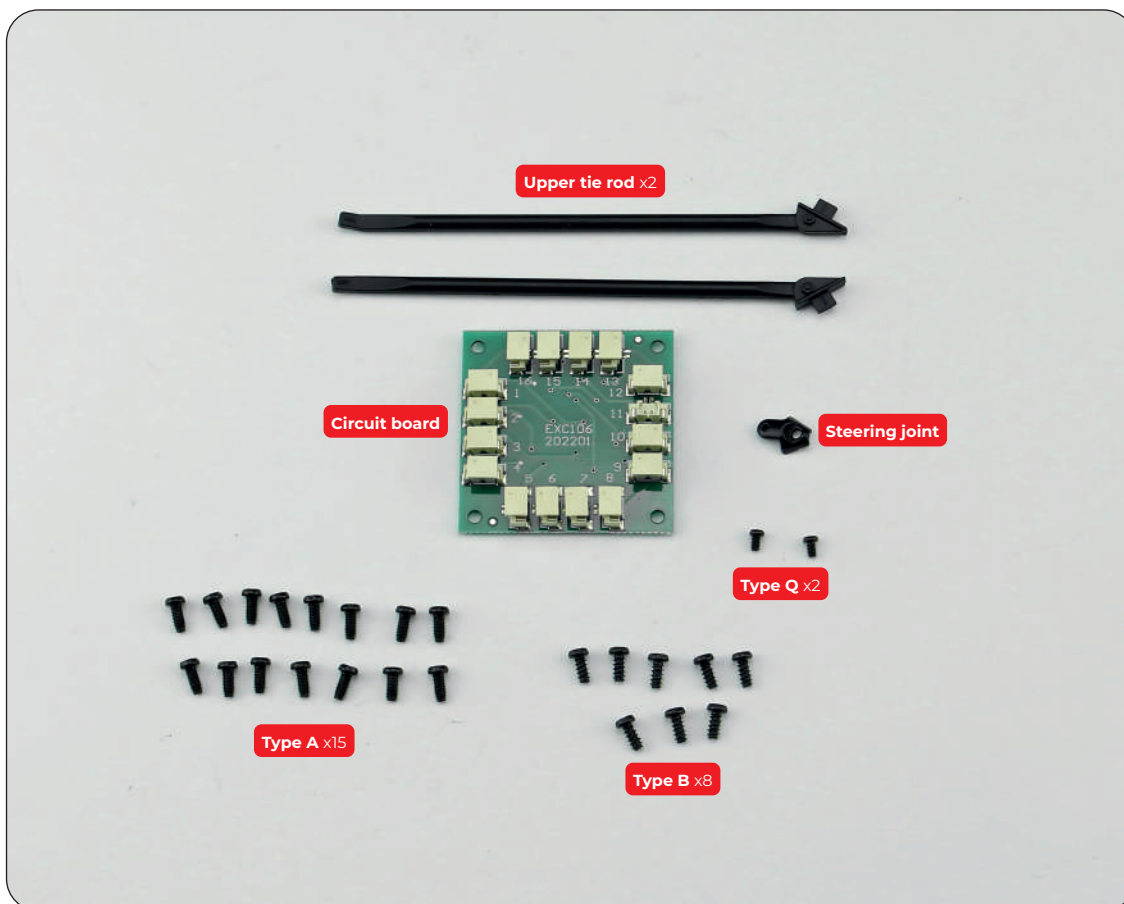

Stage 76: Fitting the Dashboard and Front Frame into the Body and Installing the Circuit Board

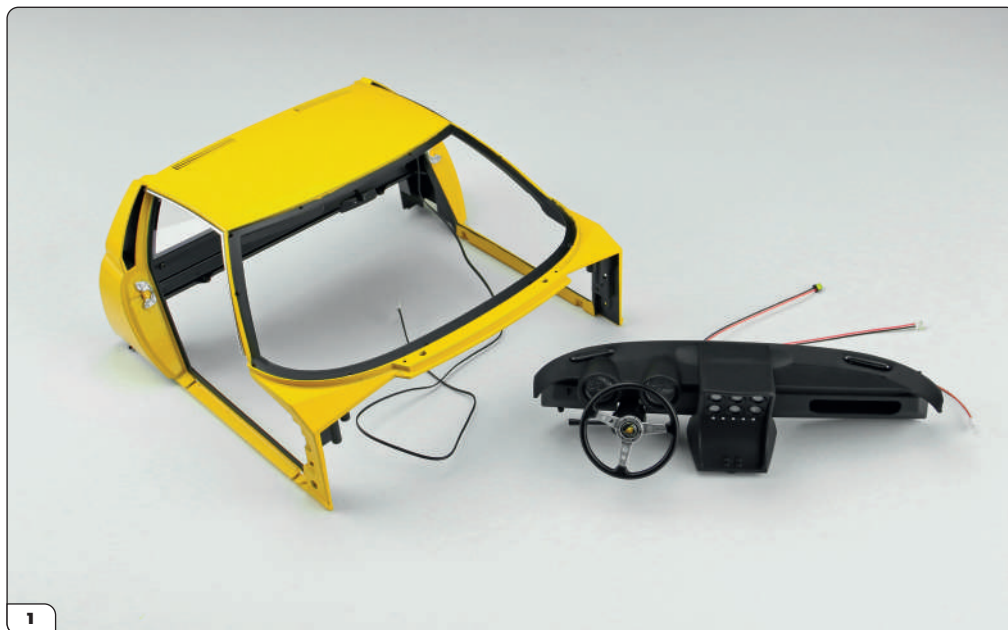

For this stage you will need the central body and dashboard assembled previously.

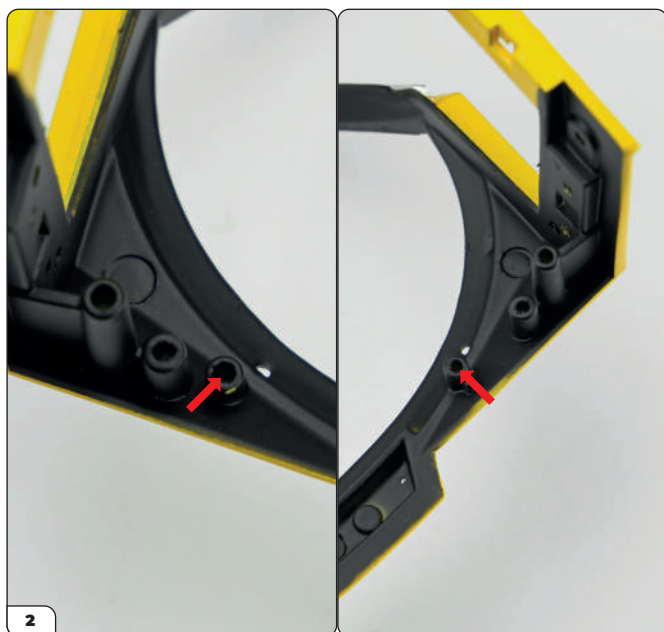

Turn the the body upside down. Inside the front, under the windscreen area, there are three drilled columns on each side: the two innermost columns (arrows) are for installing the dashboard.

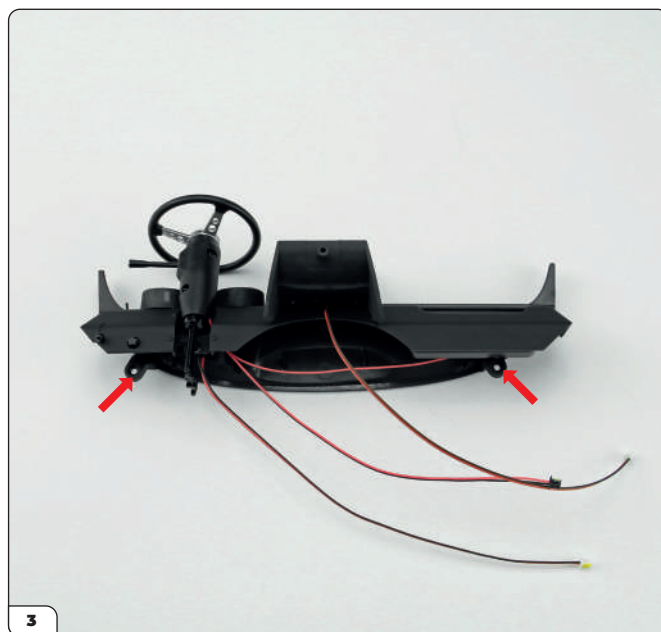

Turn the dashboard upside down. Opposite the steering wheel there are two slots (arrows) for fixing it to the body.

Stage 76: Fitting the Dashboard and Front Frame into the Body and Installing the Circuit Board

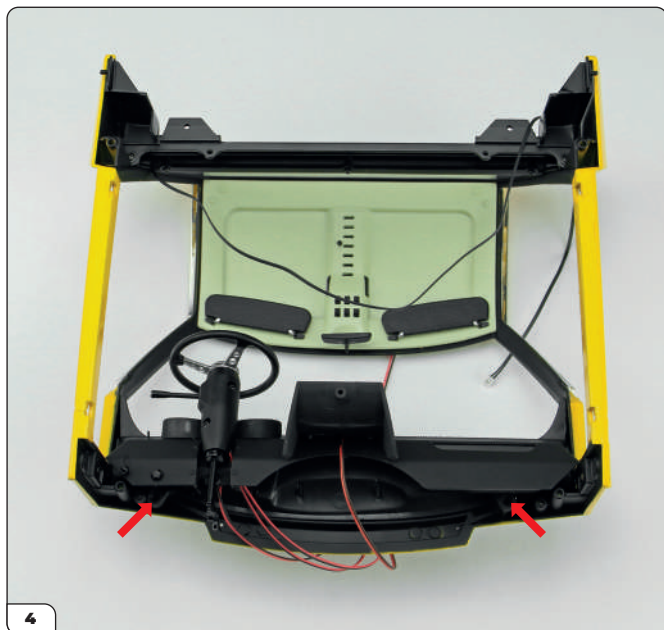

Take the dashboard and position it inside the central part of the body, taking care to match up the drilled columns and the fixing slots highlighted in steps 2 and 3 (arrows). You may find it necessary to slightly widen the body in order to fit the dashboard in place.

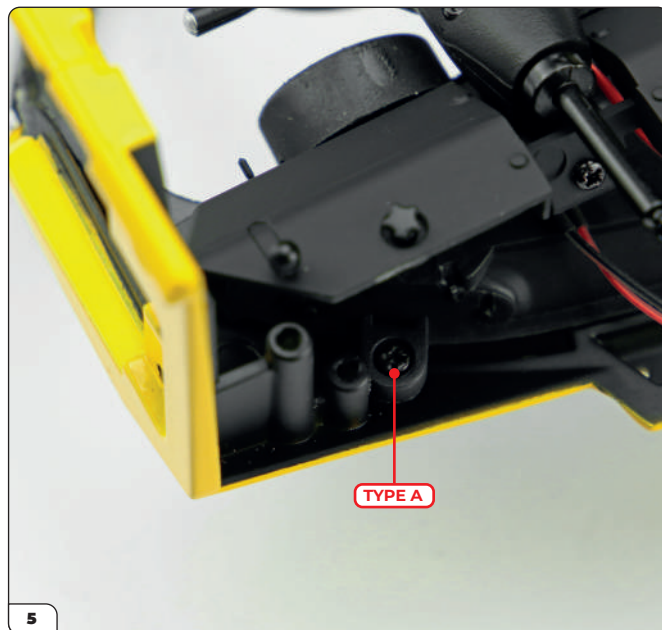

Use a Type A screw to secure the left-hand side of the dashboard. You may wish to leave the screw slightly loose until the other side (step 6) has been tightened.



Secure the right-hand side of the dashboard with a Type A screw.

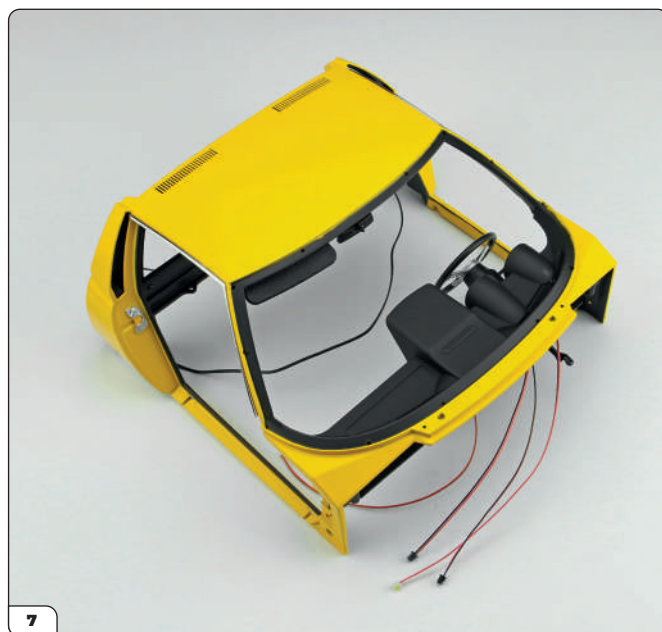

Check that the dashboard is fitted flush all the way round.

Stage 76: Fitting the Dashboard and Front Frame into the Body and Installing the Circuit Board

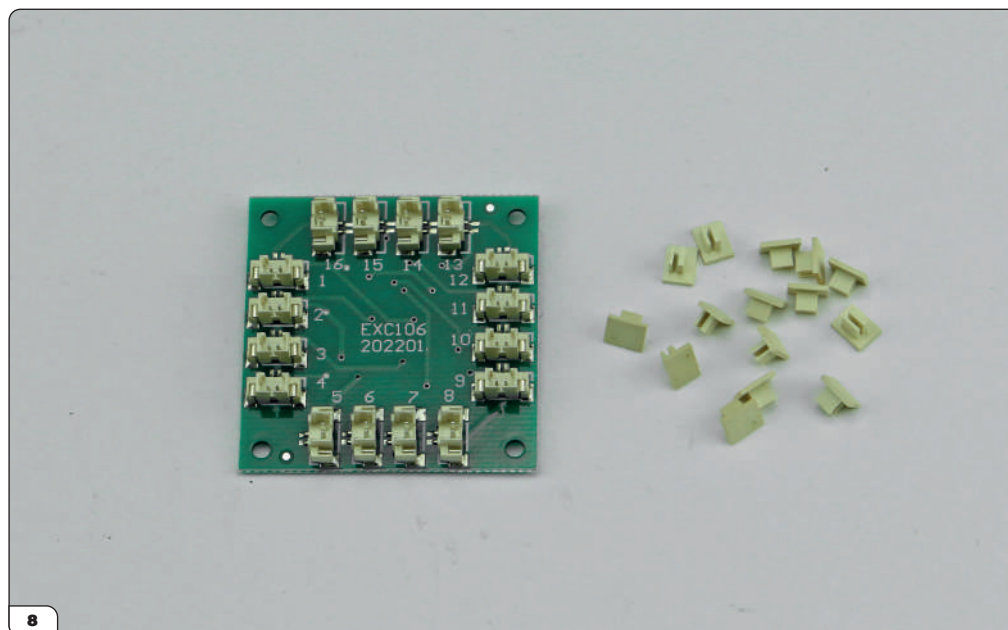

Next take the circuit board. Make sure to handle the circuit board carefully as you install it, holding it by the edges when necessary. Remove all the protective caps from the connectors as shown.

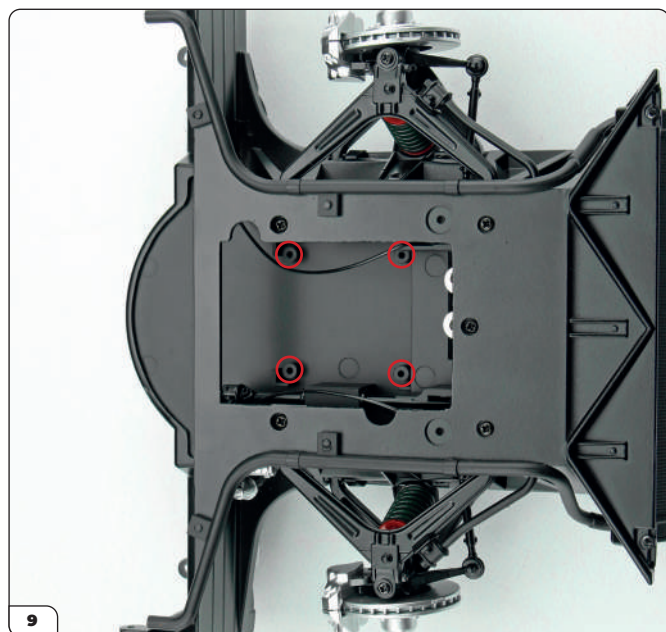

Retrieve the front frame assembly and place it upside down on your work surface as shown. There is a large rectangular opening in the center with four perforated columns (circled) inside for fixing the electronic board.

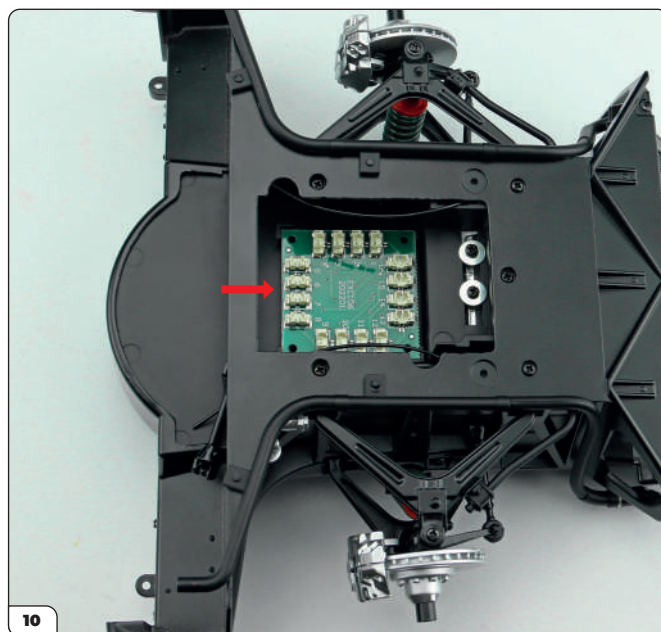

Place the circuit board in the recess inside the front frame assembly. Make sure to orient the card so that the connectors numbered 5 to 8 are facing the rear of the assembly (arrow).

Stage 76: Fitting the Dashboard and Front Frame into the Body and Installing the Circuit Board

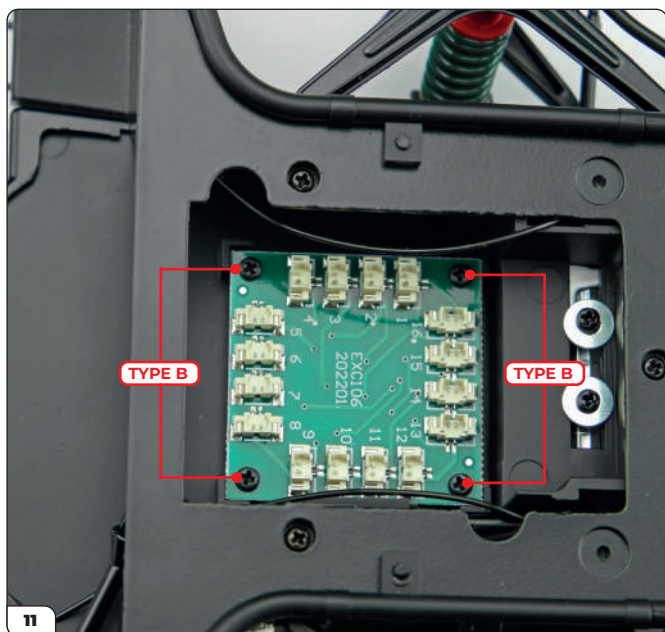

Fix the circuit board to the assembly using 4x Type B screws.

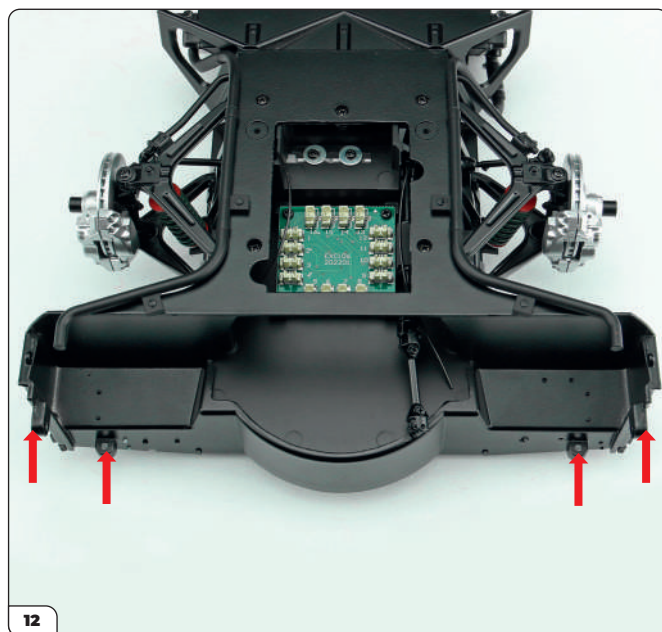

Next locate the four connection points on the front frame assembly (arrows) which are used to secure it to the body.

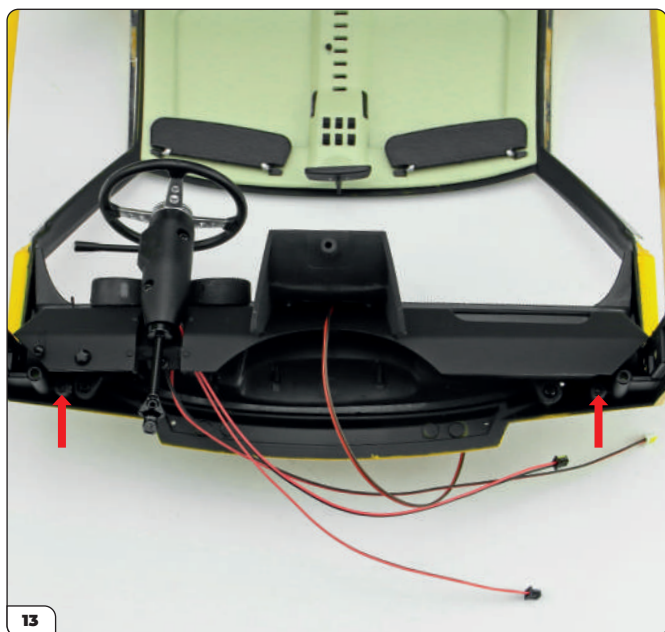

The slots fit into the drilled columns located next to the ones used to secure the dashboard (arrows).

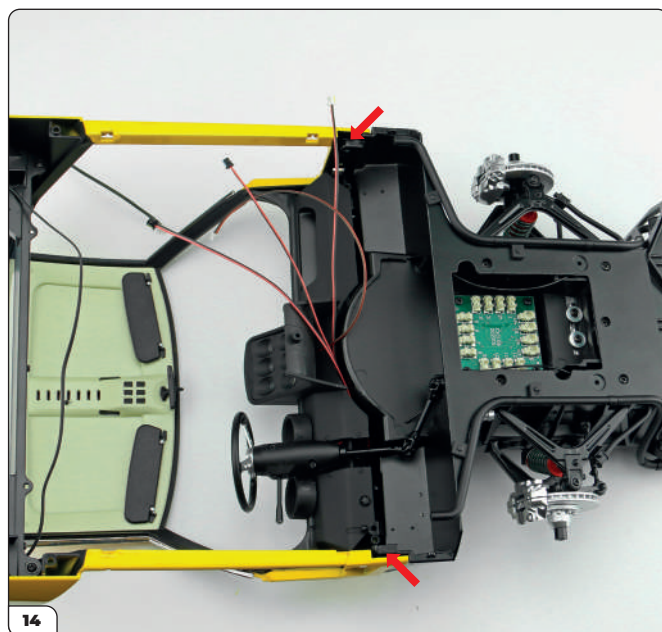

Fit the front frame assembly into the body as shown. It may be necessary to widen the body in order to fit the front frame – be careful not to apply too much force to any of the plastic areas of the model. You may wish to file excess black paint from the faces of the side connections (arrows) where they contact the body.

Stage 76: Fitting the Dashboard and Front Frame into the Body and Installing the Circuit Board



Make sure that the holes in the base of the door hinge housings (arrow) line up on both sides of the components.

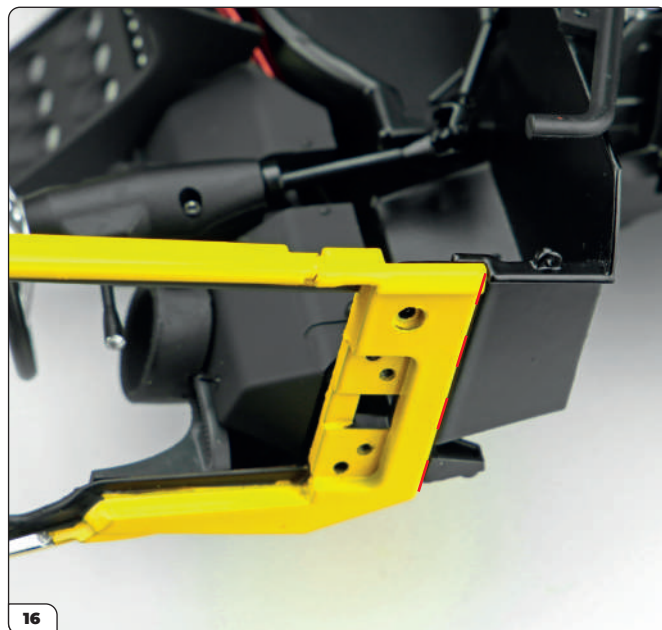

Also check that the front frame assembly is properly seated by checking alignment with the edge of the body, as shown by the dashed line.

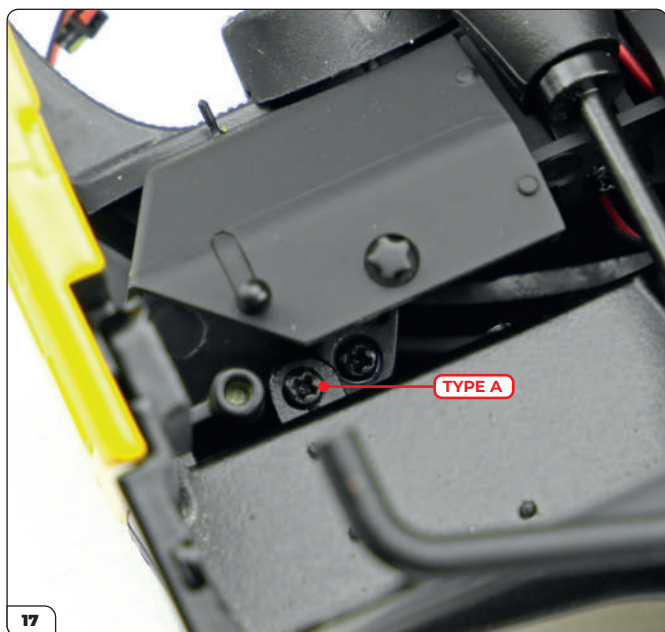

Once you have ensured that the front assembly of the chassis is positioned correctly, you can fix everything with four Type A screws. Start inserting the first one in the slot on the driver's side, located next to the dashboard fixing point.

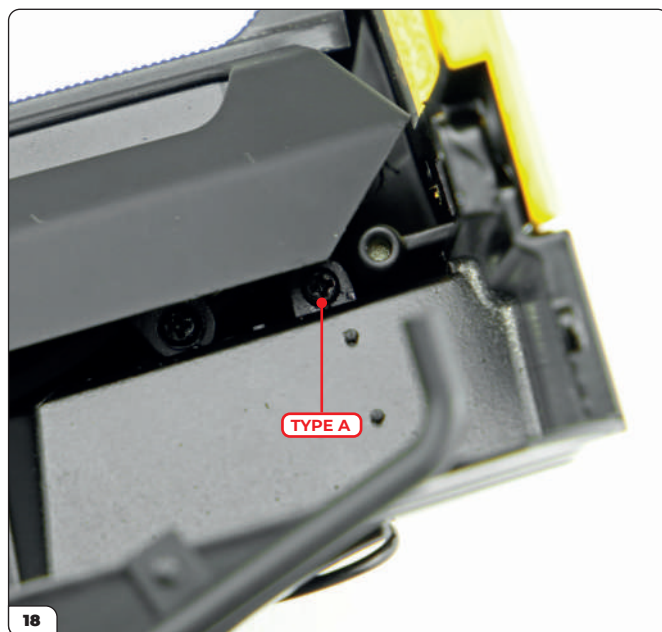

Drive the second Type A screw into the passenger side slot.

Stage 76: Fitting the Dashboard and Front Frame into the Body and Installing the Circuit Board

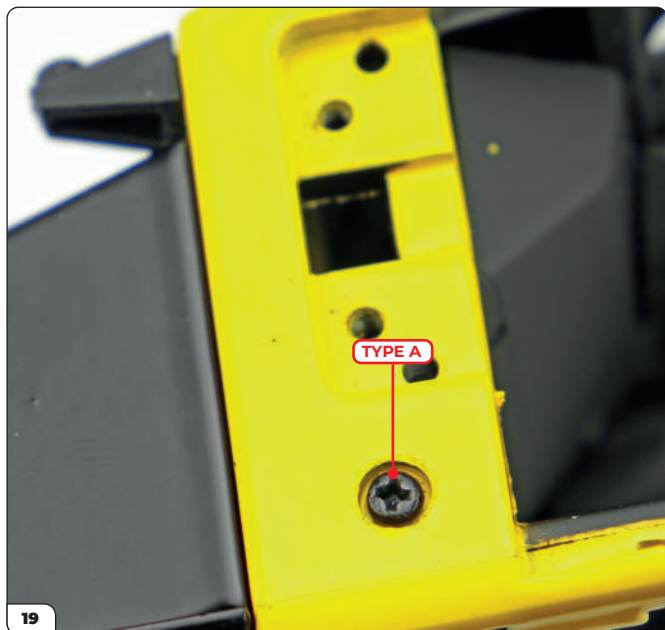

Continue to fix the assemblies together with a third Type A screw in the outer hole at the base of the driver's side door hinge housing. The screw should sit flush inside the recess.

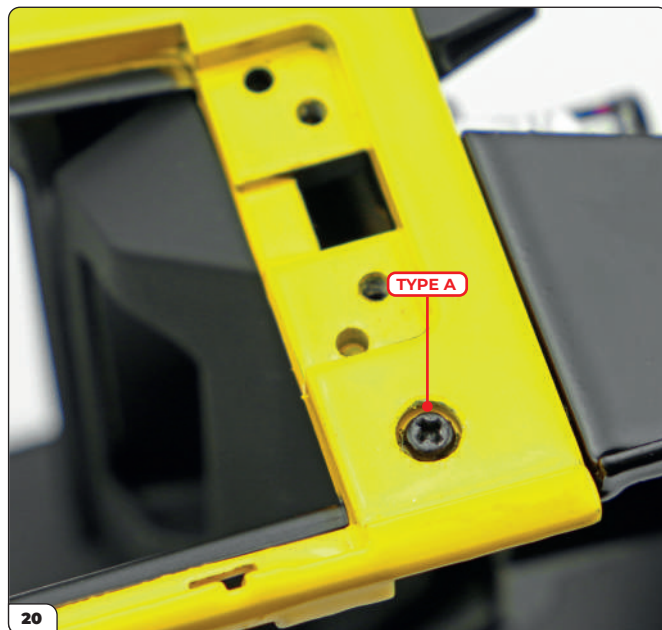

Finish fixing the front frame with the fourth Type A screw in the outer hole on the passenger's side.



Now take the steering joint and a Type Q screw.

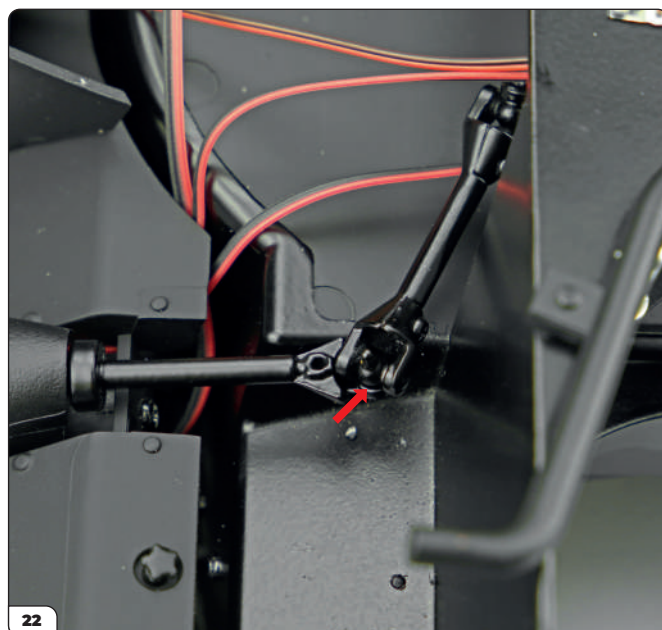

Check the front wheel hubs are parallel to the direction of travel and that the steering wheel is also in the neutral position – the ends of the steering columns should look like those in the image. Connect the two steering columns together by pressing the pin of one into the hole of the other (arrow).

Stage 76: Fitting the Dashboard and Front Frame into the Body and Installing the Circuit Board

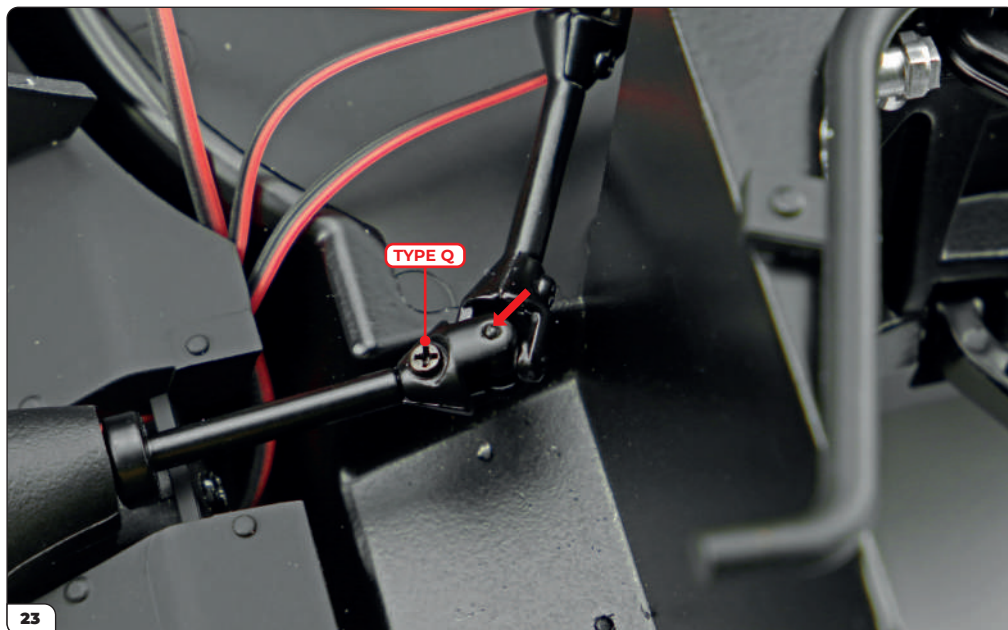

Fit the steering joint over the other pin of the steering column (arrow), then secure it in place using a Type Q screw. Test the steering by turning the wheel – if the steering doesn't engage, try tightening the screws in the silver washers, or loosen them if the wheels don't move. The steering wheel may turn a small amount both left and right before the columns begins to turn the wheels.

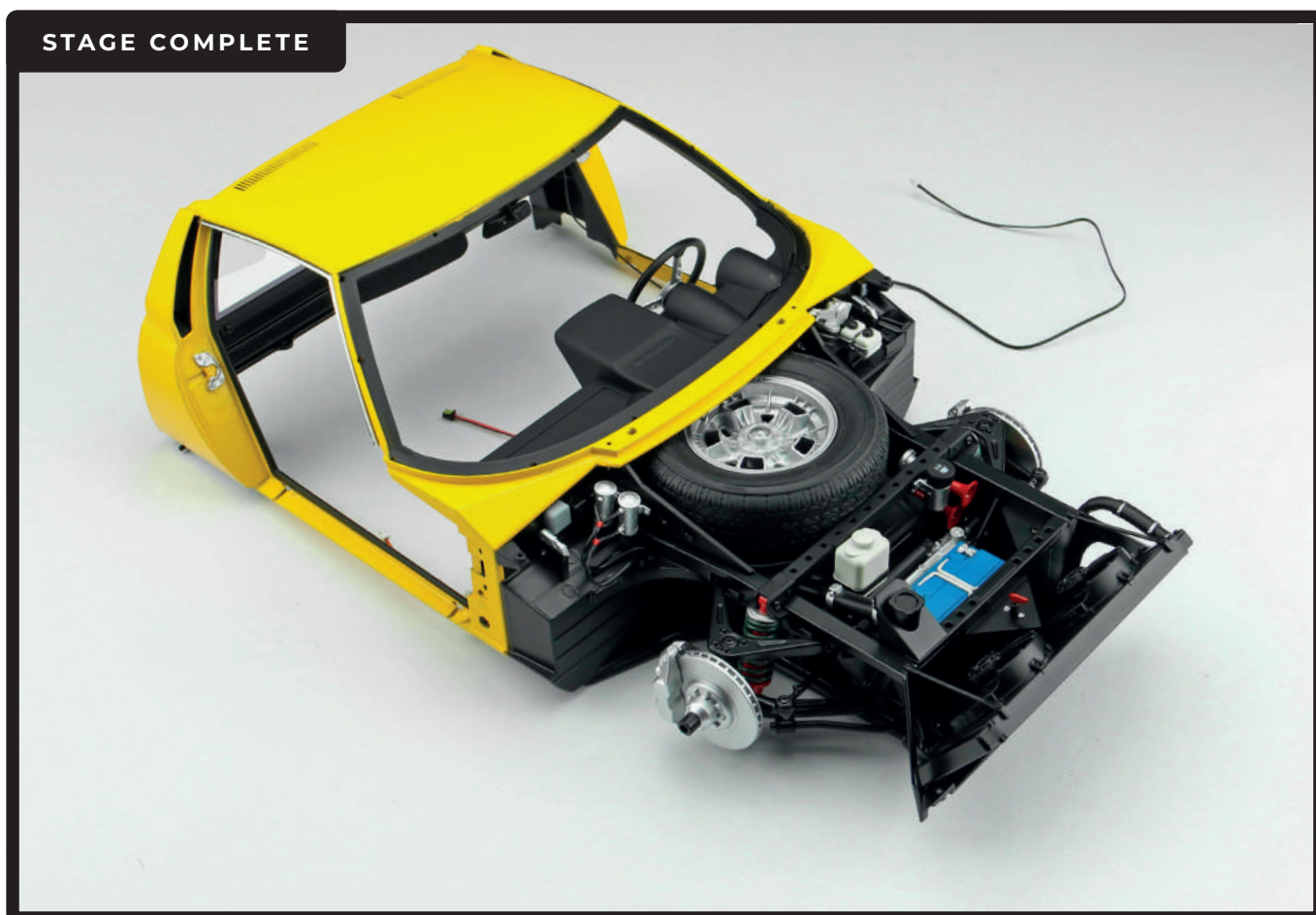

Stage 77: Connecting the Wiring and Fitting the Cockpit into the Body

With the circuit board in place, you'll start to connect up the electronic wiring for the model. You'll also need the cockpit assembly, which will be fixed in place and its wires connected up.

The parts supplied with this stage can be kept aside until they are needed later in this Pack.



STAGE 77 PARTS LIST

Name
Bonnet inner bulkhead
Bonnet side crossbar
Bonnet side crossbar
Bonnet central crossbar
Type B screws x3

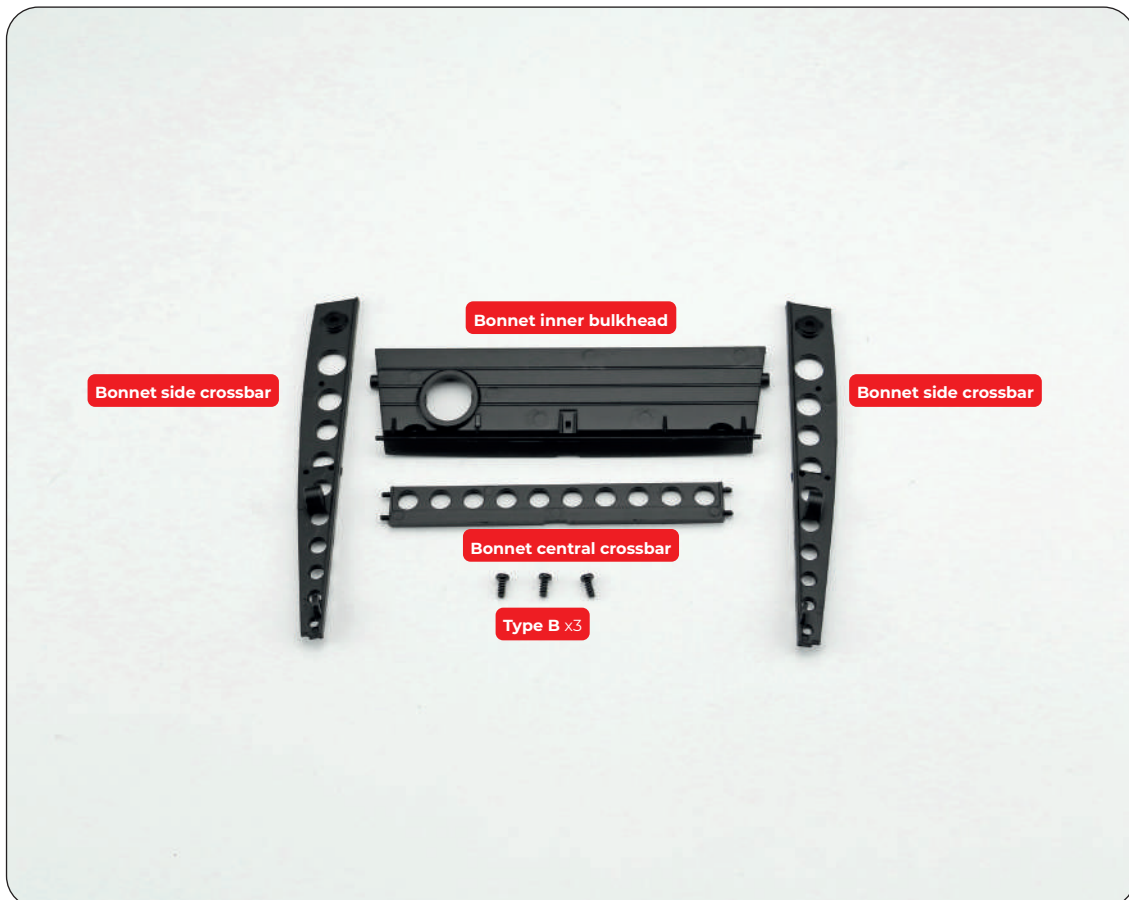

Stage 77: Connecting the Wiring and Fitting the Cockpit into the Body

CONNECTION SCHEME

Connection Number	Function	Plug Colour	Pad Print Colour	Supplied in Stage N°
1	Indicator switch	Black	Yellow	46
2	Horn switch	Black	Blue	46
3	Accelerator switch	Black	White	44
6	Engine switch	Black		42
7	Instrument panel LEDs	White		7
8	Dashboard LED	White	Yellow	46
13	Brake switch	Black	Green	44
14	Left door switch	White		5
15	Right door switch	White	Blue	52
16	Interior light	White	Red	49

In this stage you will begin to connect the cables to the circuit board of the model. The table above shows a summary of the connections including the number of the connector on the circuit board in which it is inserted, the function for which it is intended, the colour of the plug and the pad printing (if there is one), as well as the number of the stage with which it was supplied.

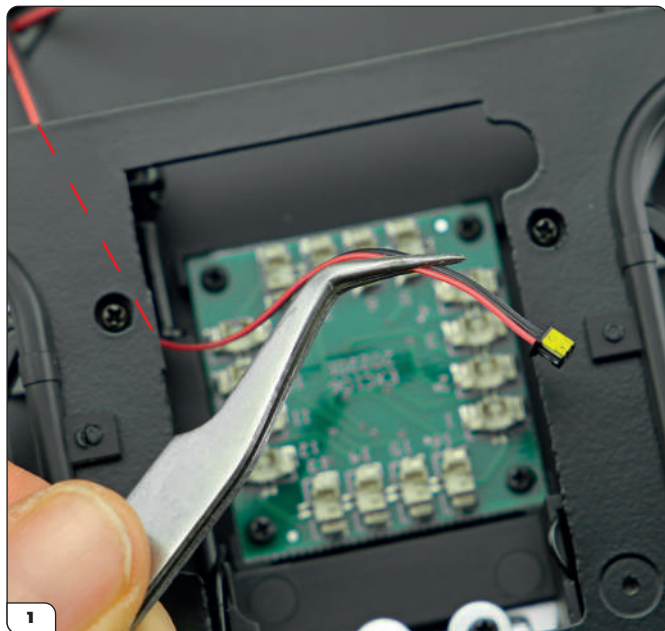

Take the indicator switch coming from the steering wheel column, which has a black plug with a yellow pad. Pass it under the crossmember of the frame (dashed line).

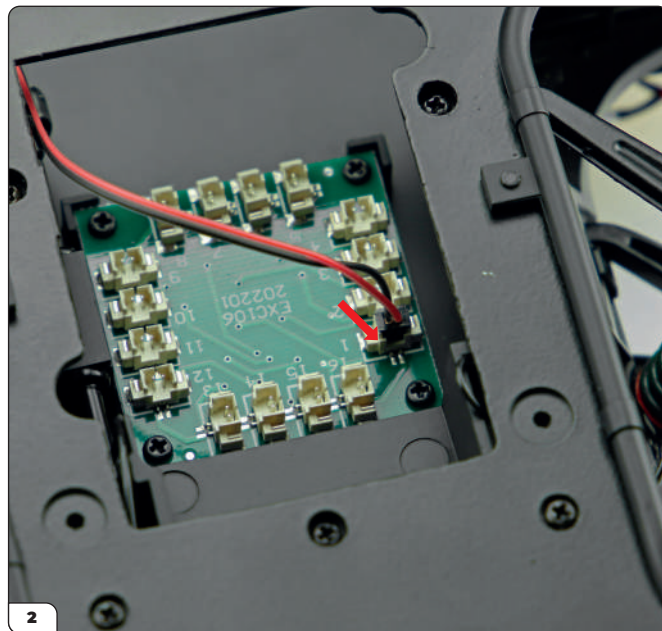

Insert the plug into connection 1 on the circuit board (arrow). We recommend using tweezers to push the plug firmly into place – be careful to align the plug correctly with the pins of the circuit board connection so as not to bend them.

Stage 77: Connecting the Wiring and Fitting the Cockpit into the Body

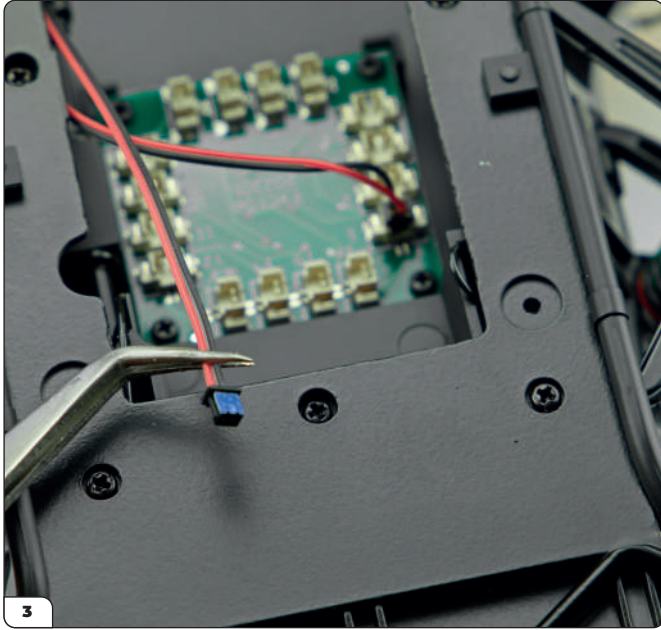

Take the horn switch (black plug, blue panel) coming from the steering wheel column and pass it under the crossmember in the same way.

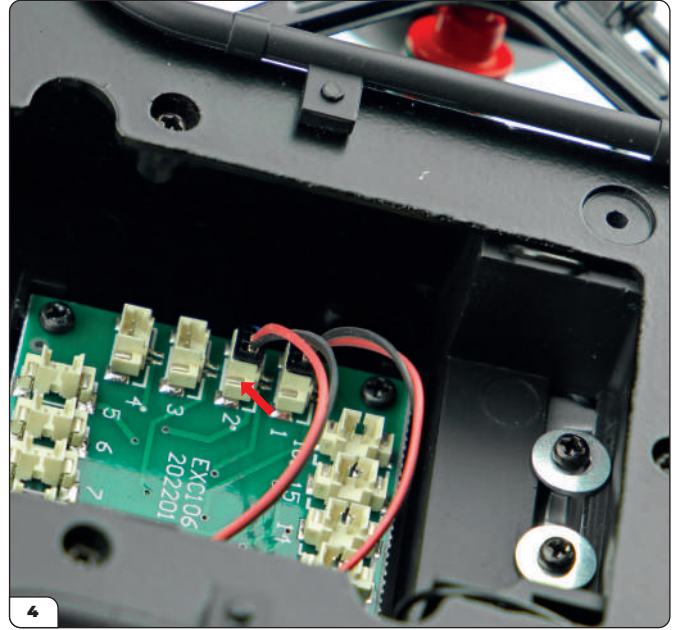

Plug the horn switch into connection 2 (arrow).



Take the instrument panel LED wire, which is white with red/black cables, and route it under the crossmember.

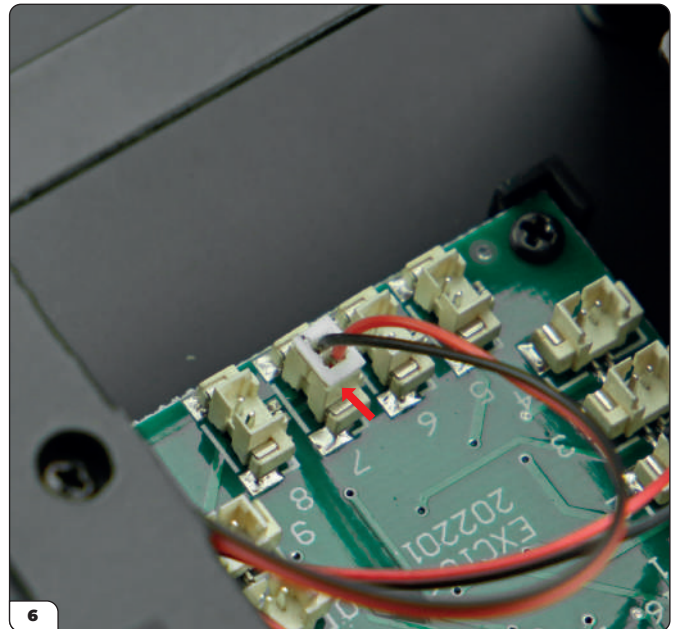

Plug the instrument panel LED into connection 7 (arrow).

Stage 77: Connecting the Wiring and Fitting the Cockpit into the Body

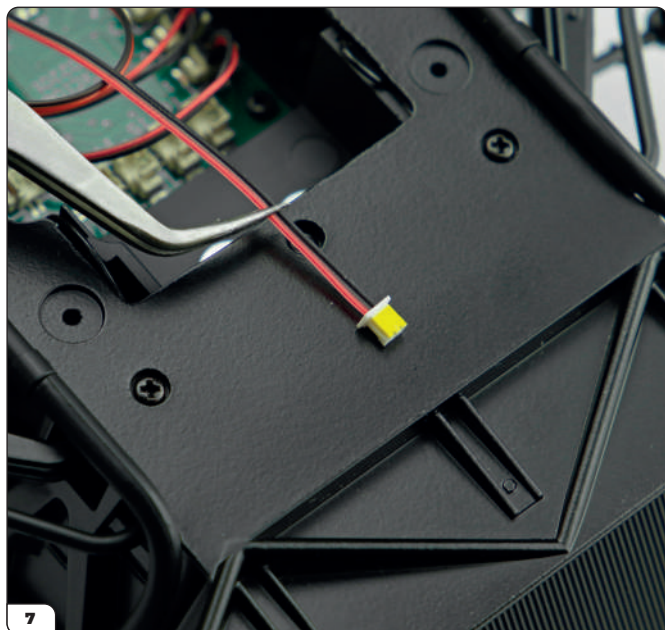

Take the dashboard LED wire (white plug, yellow panel) and route it under the crossmember.

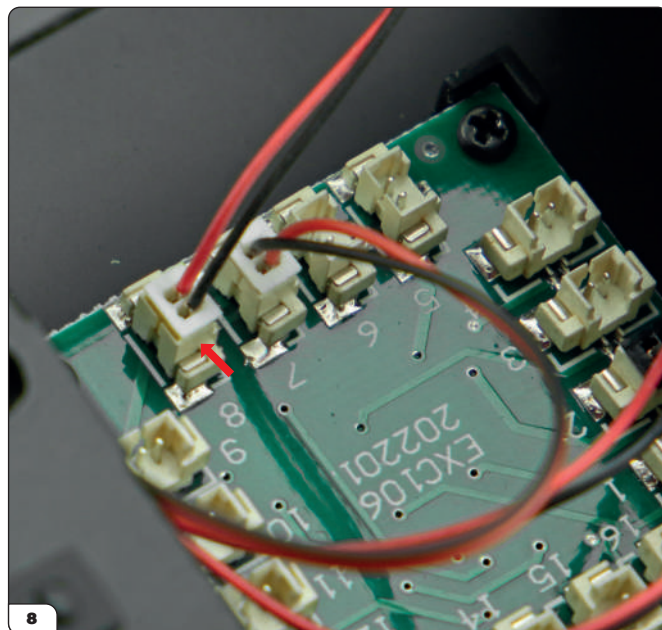

Plug the dashboard LED into connection 8 (arrow).



Retrieve the cockpit assembly and place it on your work surface. There are two holes on the front for fixing it to the body (arrows).

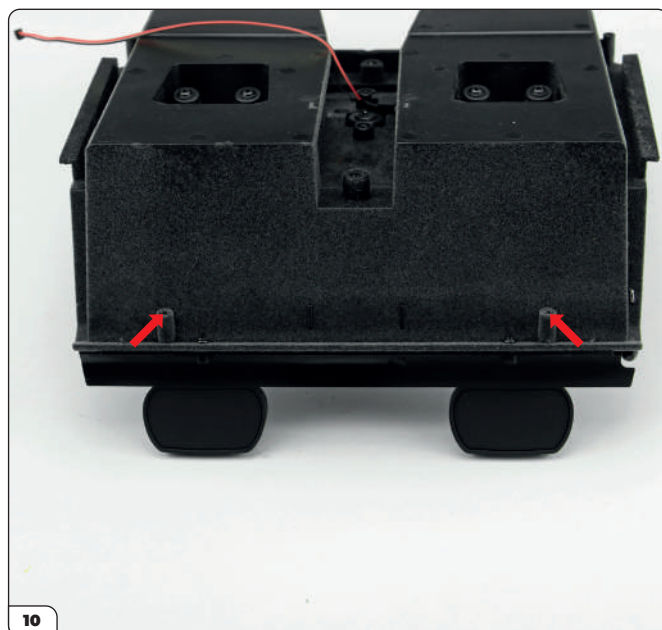

At the rear of the cockpit, below the headrests, there are two more holes for fixing (arrows).

Stage 77: Connecting the Wiring and Fitting the Cockpit into the Body



Orient the body assembly on your work surface as shown and locate the four connection points for fitting the cockpit (arrows).

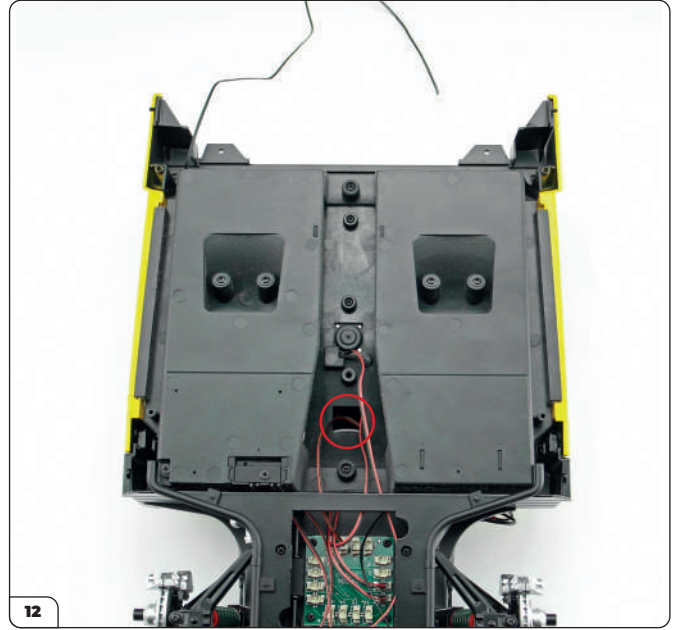

Align the cockpit with the body as shown. Insert the holes below the headrests highlighted in step 10 underneath cross frame firewall and over the two connection points highlighted by the blue arrows in step 11. Route the wires of the cockpit under the crossmember. If you wish, you can disconnect the plugs in connectors 7 and 8 and reroute the wires through the rectangular hole (circled) before pushing the cockpit into place.

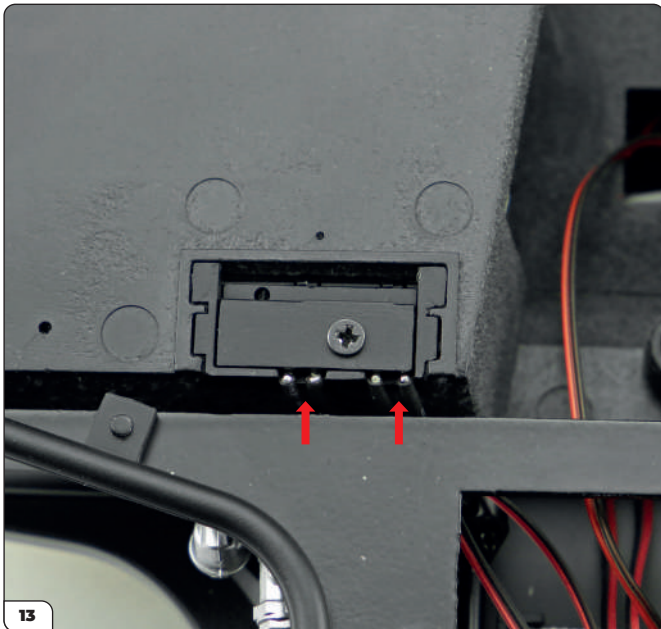

Before pushing the front of the cockpit into position, ensure the wires protruding from the pedal housing are flat against the cockpit wall as shown (arrows). The connections are delicate – take care when inserting the cockpit the wires don't snag or bend out of place.

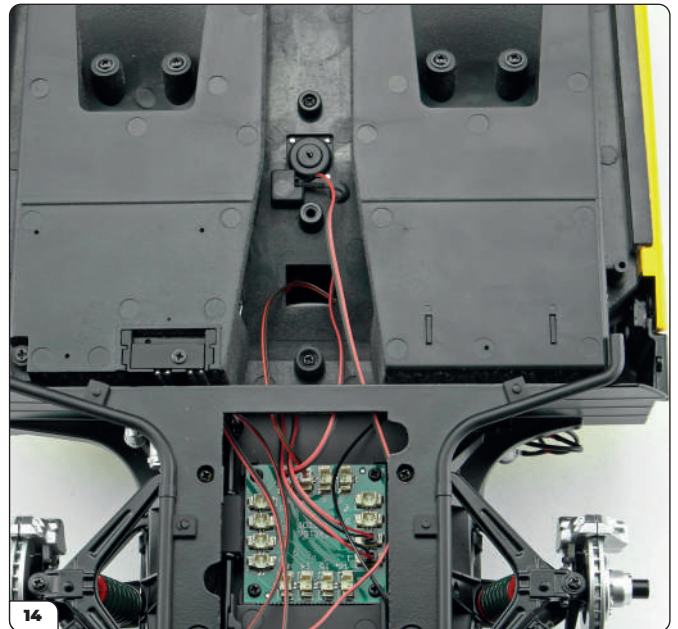

Push the front of the cockpit down until the holes highlighted in step 9 align with the connection points highlighted with the red arrows in step 11.

Stage 77: Connecting the Wiring and Fitting the Cockpit into the Body

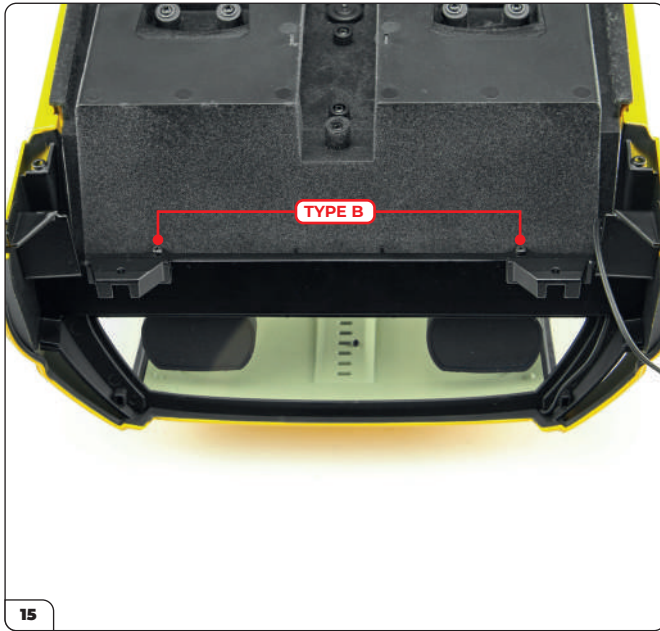

Fix the cockpit in place at the rear using 2x Type B screws (supplied with Stage 76).

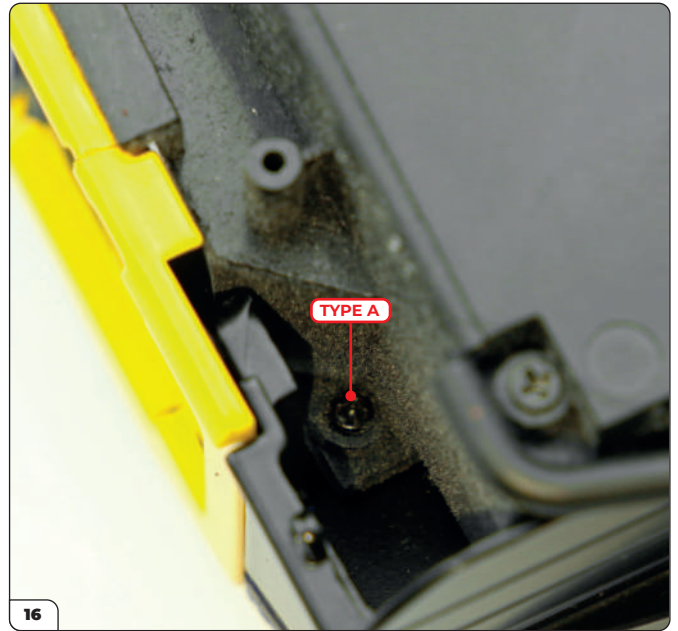

Use a Type A screw (supplied with Stage 76) to secure the left-hand side of the cockpit at the front. We recommend using the screwdriver supplied with Stage 2. Press down carefully on the cockpit floor to ensure the screw finds purchase with the hole underneath.

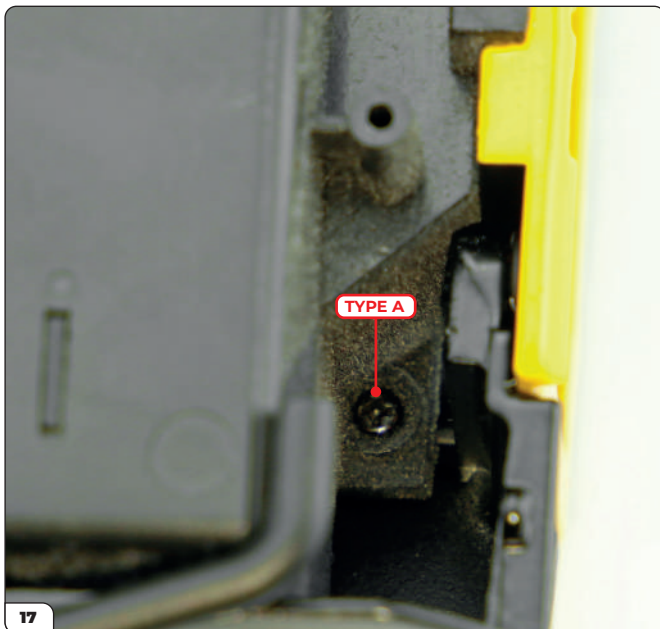

Use another Type A screw (supplied with Stage 76) to secure the right-hand side of the cockpit in the same manner.

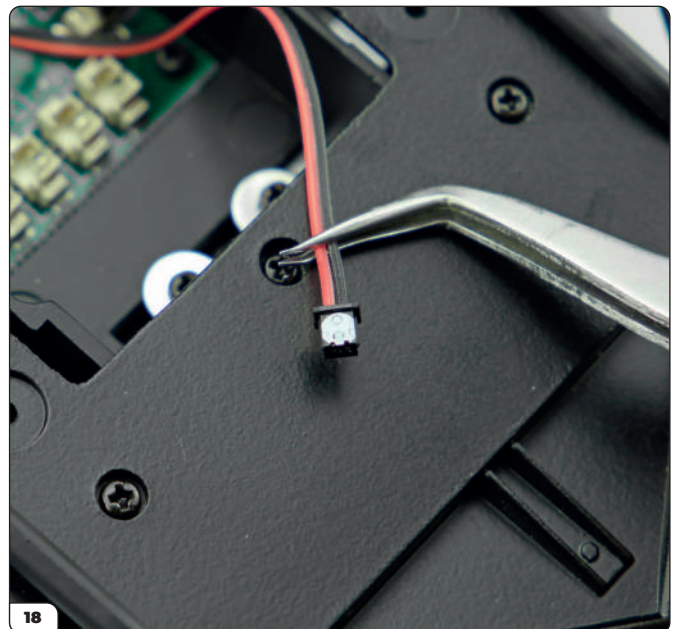

Take the plug of the accelerator switch (black plug, white panel).

Stage 77: Connecting the Wiring and Fitting the Cockpit into the Body

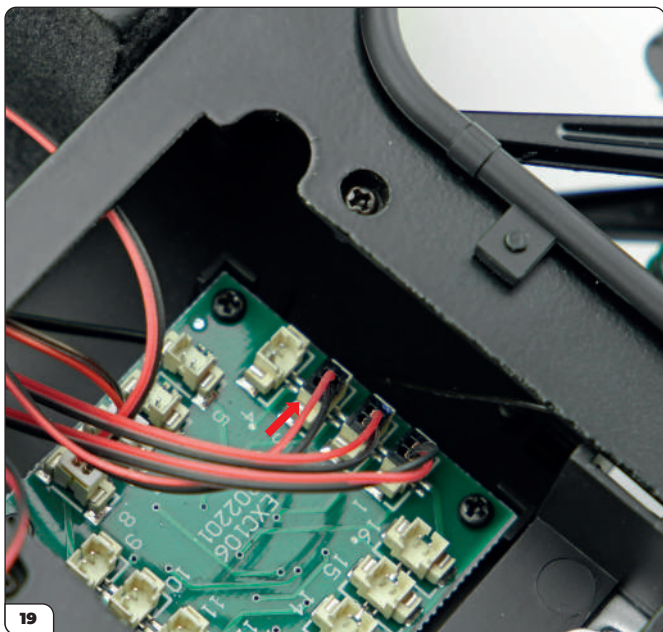

Plug the accelerator switch into connection 3 (arrow).

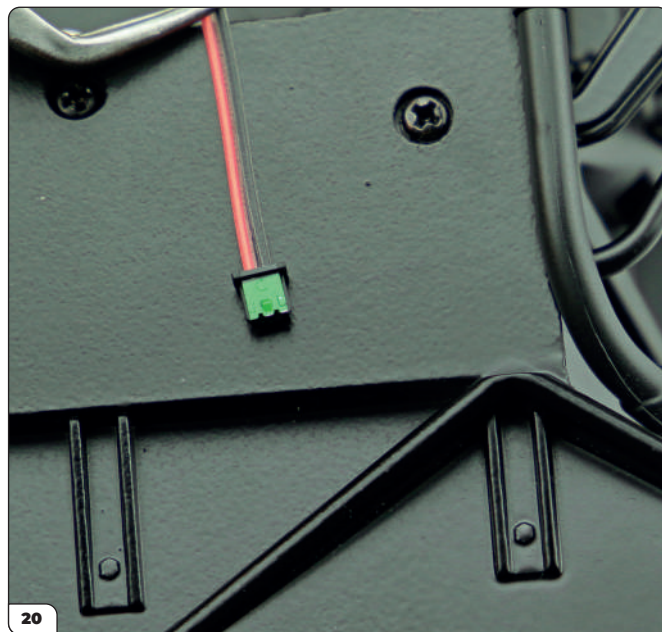

Next take the brake switch (black plug, green panel).

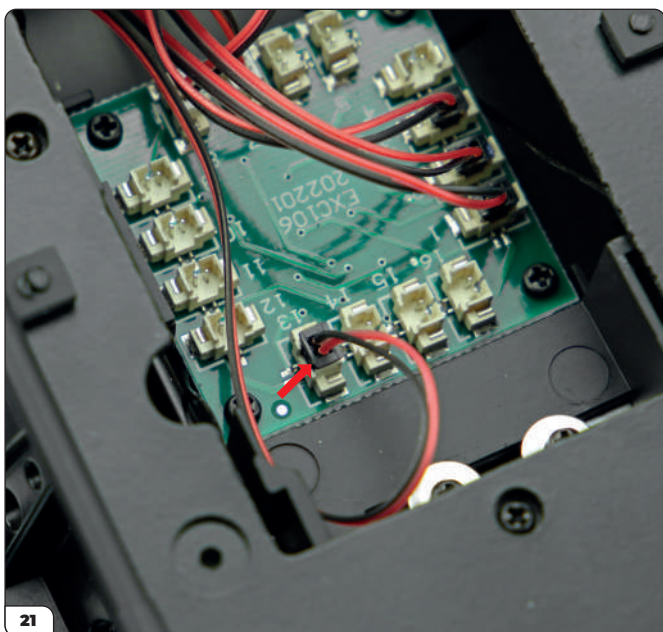

Plug the brake switch into connection 13 (arrow).

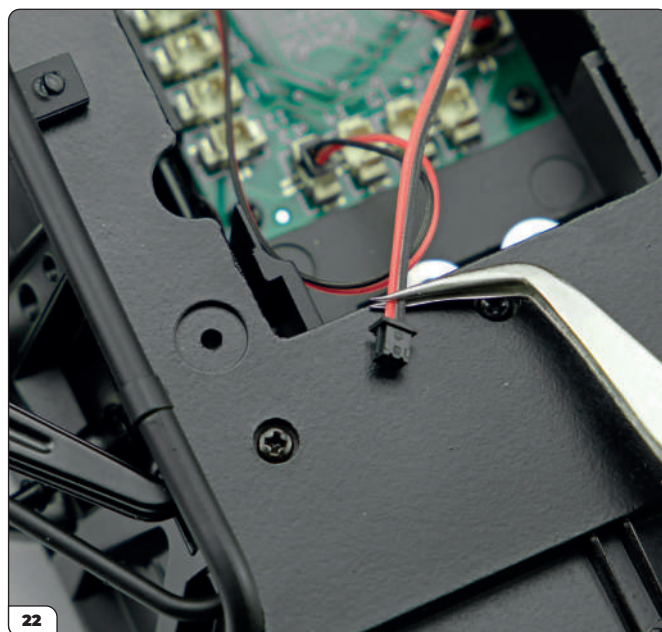

Now take the engine switch (black plug).

Stage 77: Connecting the Wiring and Fitting the Cockpit into the Body

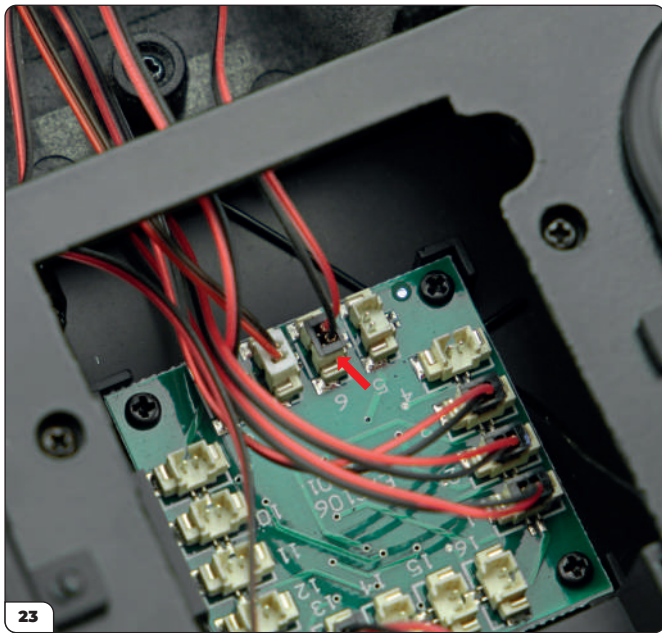

Plug the engine switch into connection 6 (arrow).

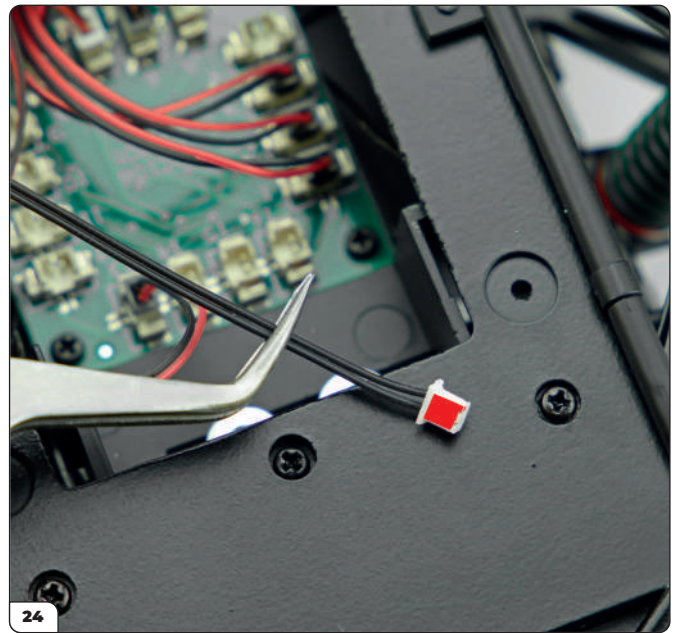

Finally, take the interior light switch (white plug, red panel). Route the cable under the crossmember if not done so already.

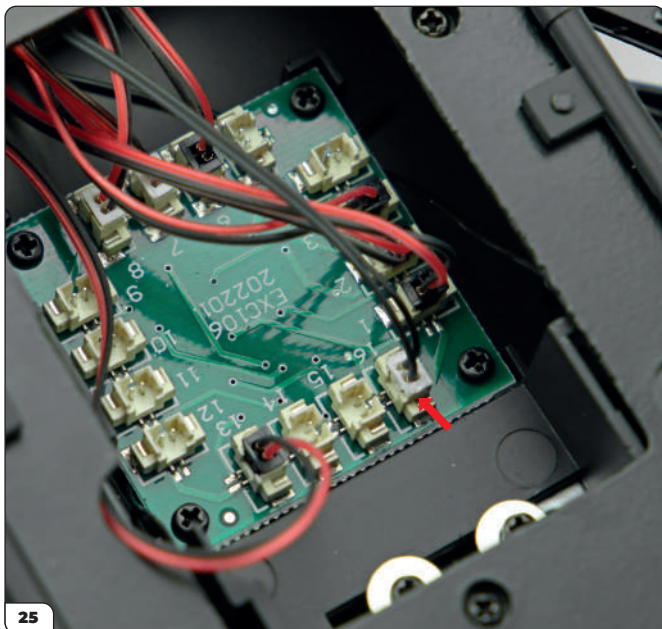

Plug the interior light into connection 16 (arrow).

Stage 77: Connecting the Wiring and Fitting the Cockpit into the Body

STAGE COMPLETE



Stage 78: Fitting the Rear Frame and Installing the Upper Tie Rods

You'll now fix the rear frame assembly to the body, then attach the upper tie rods which were supplied in Stage 76.

The parts supplied with this stage can be kept aside until they are needed later in this Pack.



STAGE 78 PARTS LIST

Name
Bonnet reinforcement frame
Right support
Left support
Right perforated plate
Left perforated plate
Type A screws x3
Type B screws x7

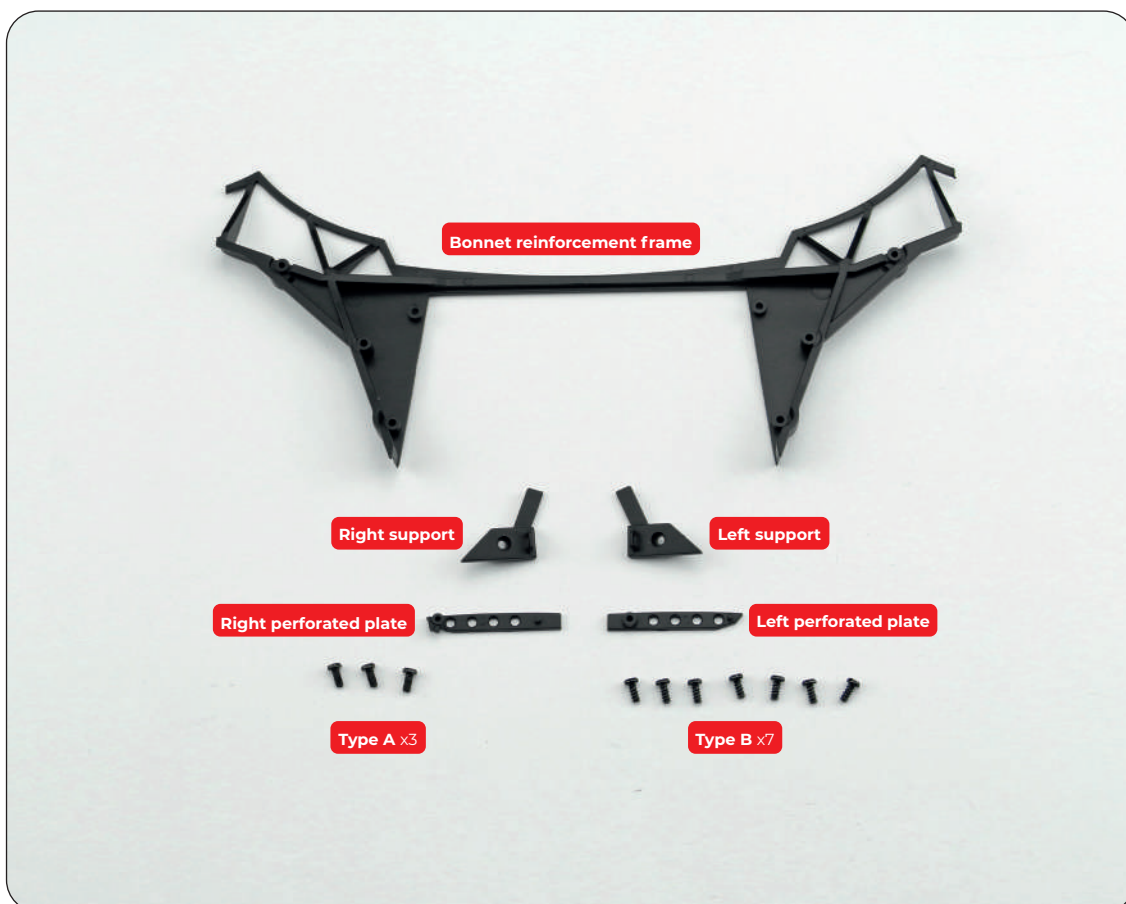

Stage 78: Fitting the Rear Frame and Installing the Upper Tie Rods

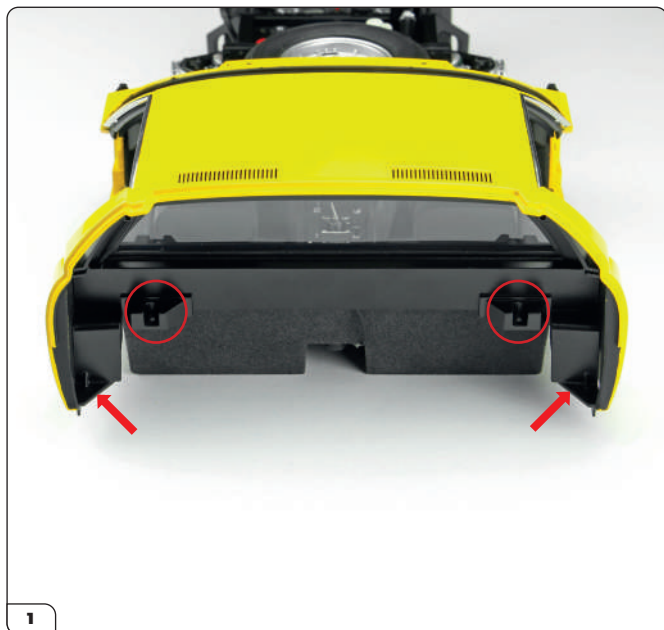

The first part of this stage will be fitting the rear frame into the body. Take the body assembly and locate the four fixing points: the two trapezoid-shaped protrusions along the cross frame firewall (circled) and the two triangular plates underneath them (arrows).

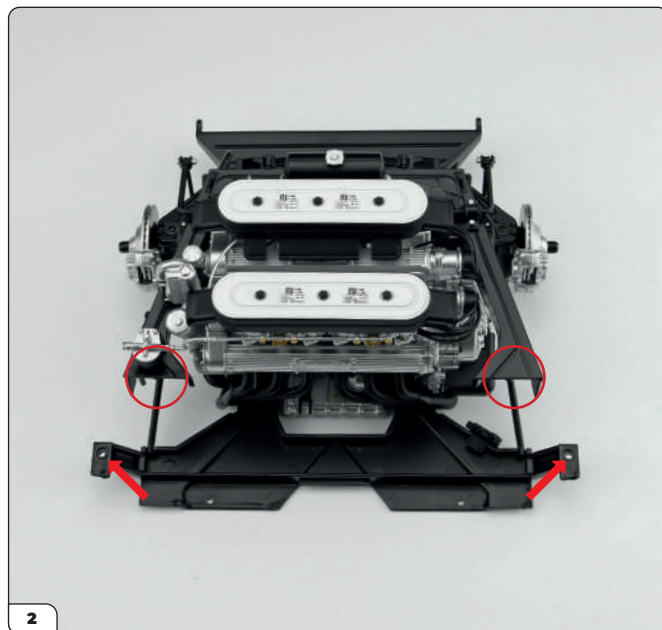

Take the rear frame assembly and locate the corresponding fixing points for fitting it into the body, highlighted by the circled areas and arrows.

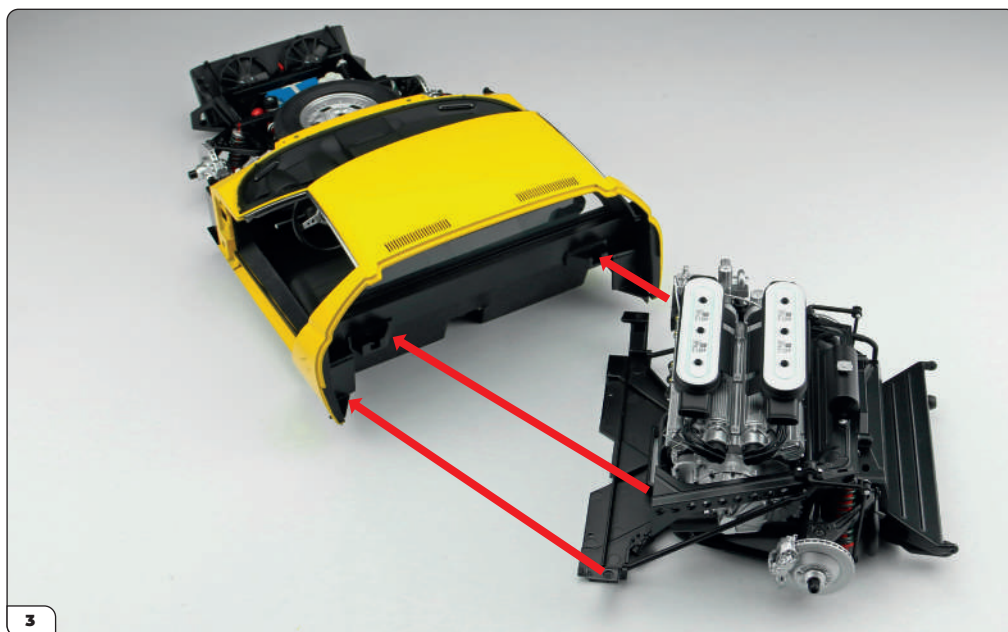

Align the body and the rear frame assemblies with each other as shown. Connect the two together by fitting the fixing points highlighted in steps 1 and 2.

Stage 78: Fitting the Rear Frame and Installing the Upper Tie Rods

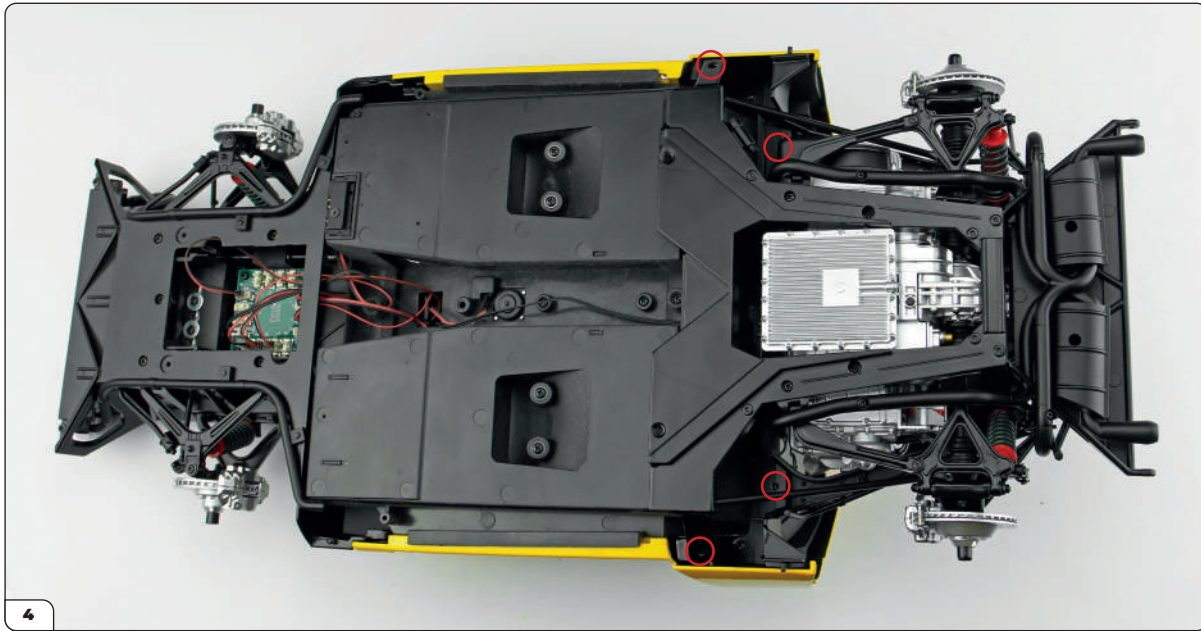

To fix the rear frame, take 4x Type A screws (supplied with Stage 76). Holding everything in place, carefully turn the body and the rear frame assembly upside down. Hold the the rear frame up so that it rests on the cradle of the cockpit and the fixing points fit into their respective seats. Check the holes for fixing are aligned (circled).

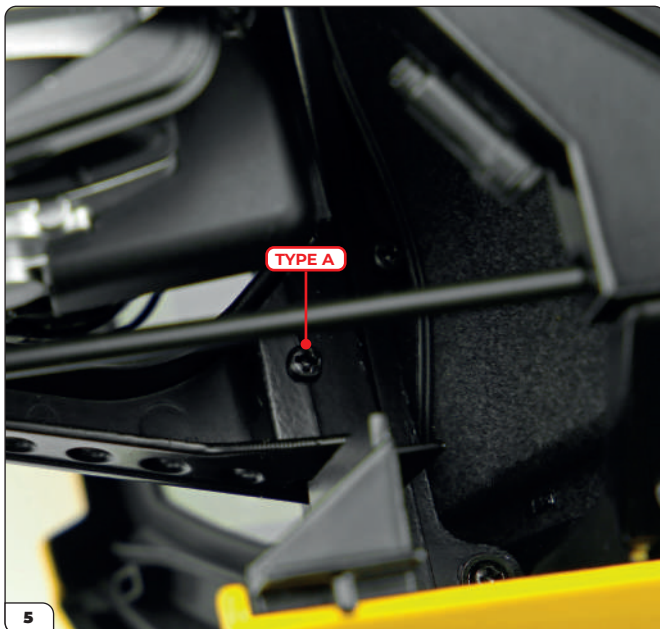

Starting on the driver's side, drive one of the Type A screws into the trapezoid-shaped connection.



Drive another of the Type A screws into the trapezoid-shaped connection on the passenger's side.

Stage 78: Fitting the Rear Frame and Installing the Upper Tie Rods

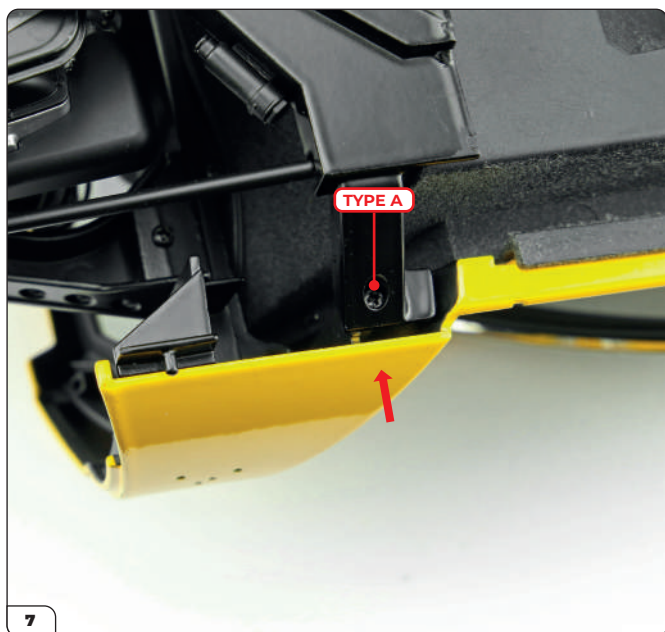

Returning to the driver's side, fasten the outermost connection point with a Type A screw. You may need to apply some pressure to the body (arrow) to ensure the holes are aligned as you drive the screw in.

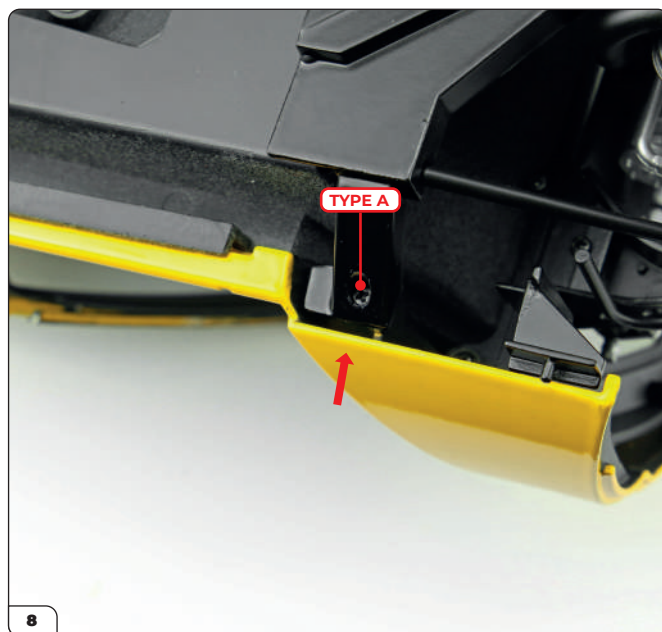

Finish securing the rear frame by fastening the outermost connection point on the passenger's side with a Type A screw.



The assembly should look like this once the rear frame has been fixed to the body.

Stage 78: Fitting the Rear Frame and Installing the Upper Tie Rods



Now take the two upper tie rods supplied with Stage 76 and lay them on your work surface as shown. The rods have a slightly curved end (arrows) and a fake screw at the opposite end. Each rod must be mounted with the nut (circled) of the fake screw facing towards the inside of the frame, while the hexagonal head faces outwards.

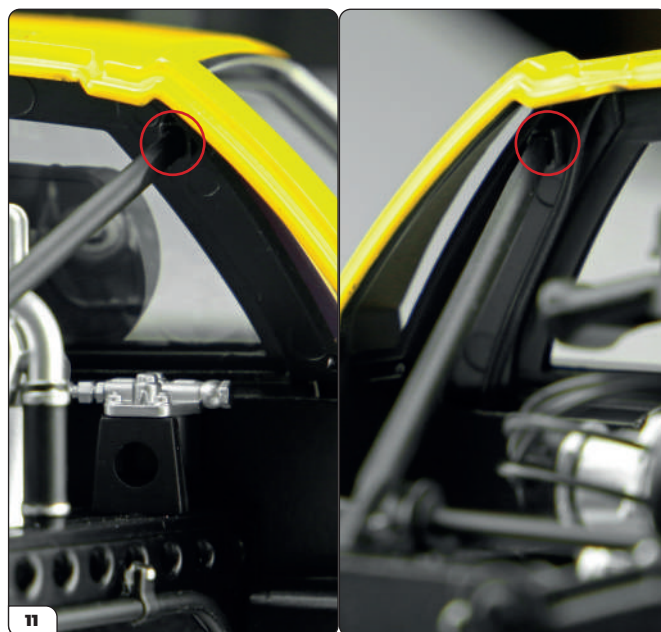

Take the rods and test fit them. Insert the pins of the curved ends into the square holes located on the sides of the rear window support (circled).



Carefully flex the right rod from the middle and guide its triangular end into the slot located on the rear frame (arrow). Note the nut facing inwards (circled).

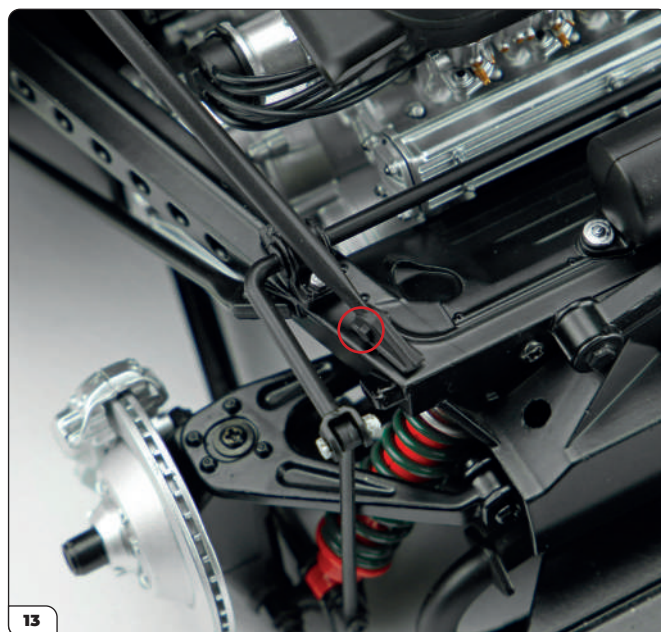

Repeat with the other rod in the same manner. You can see the hexagonal bolt head is facing outwards (circled).

Stage 78: Fitting the Rear Frame and Installing the Upper Tie Rods

STAGE COMPLETE



Stage 79: Attaching the Left and Right Doors

With the front and rear frames installed into the body, you can now fix the left and right doors onto the main assembly. Then you'll connect the switches from the doors to the circuit board.

The parts supplied with this stage can be kept aside until they are needed later in this Pack.



STAGE 79 PARTS LIST

Name
Headlight support
Headlight housing
Support plate x2
Headlight housing
Headlight lens
Type B screws x3
Headlight lens
Headlight LED
Headlight LED



Stage 79: Attaching the Left and Right Doors

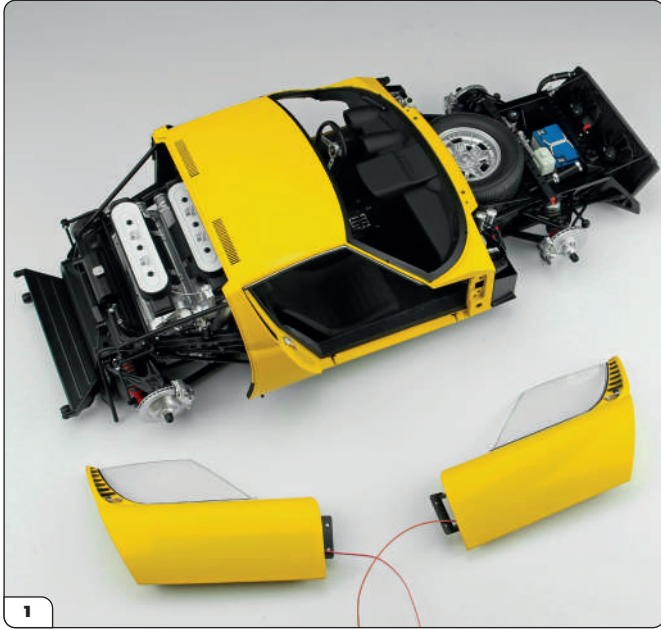

Place the main assembly on your work surface and retrieve the left and right doors assembled in Stages 6 and 53.



Starting with the right-hand side, locate the square hole in the housing for the door hinge (arrow).

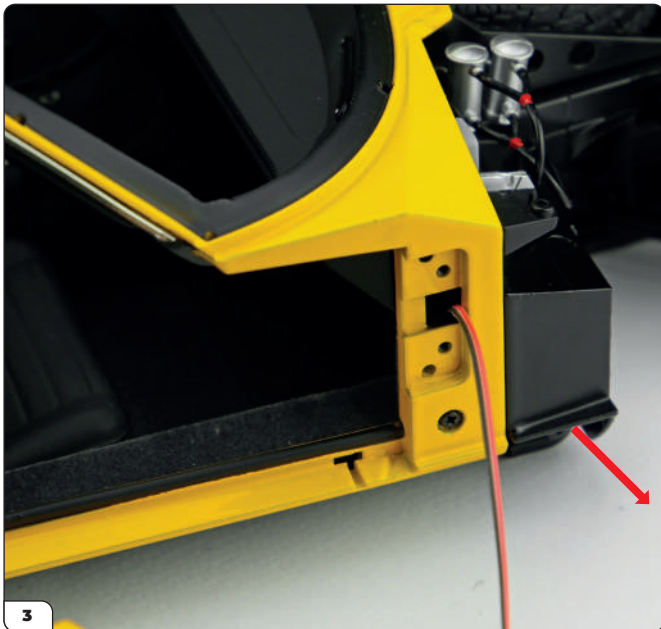

Thread the plug for the door switch through the square hole and through to the lower part of the front frame (arrow – see step 4).

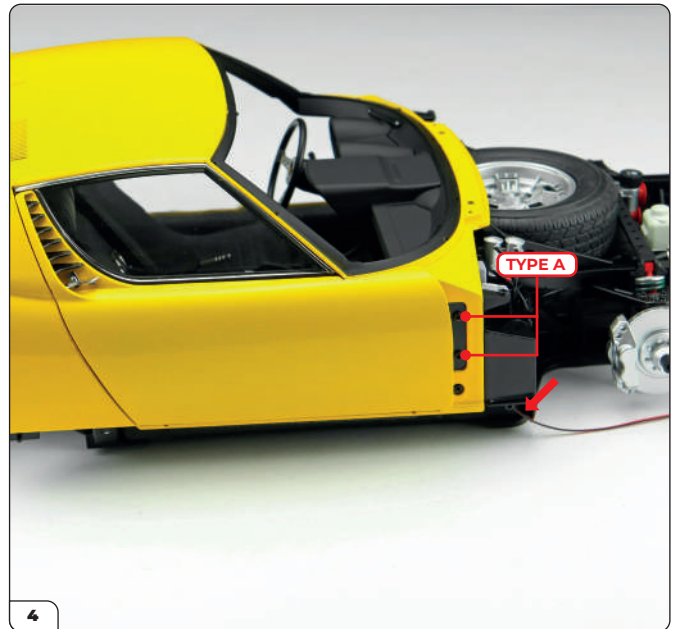

Position the right door as shown and fit the hinge into its housing. Start to secure the door using 2x Type A screws (supplied with Stage 76), but don't fully tighten the screws yet. Note the wire of the door switch has been threaded through the lower part of the frame (arrow).

Stage 79: Attaching the Left and Right Doors



Ensure that the door is closed and well aligned with the body (dashed lines), then tighten the Type B screws.

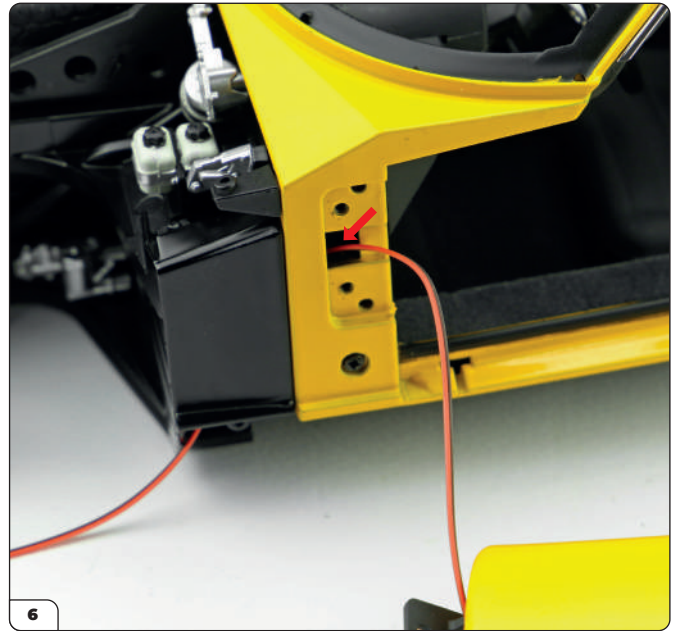

Take the left door and thread the plug through the square hole (arrow) on the left-hand side in the same manner as before. We recommend using a pair of tweezers to grasp the plug through the rectangular hole to get it at the correct angle to fit through.

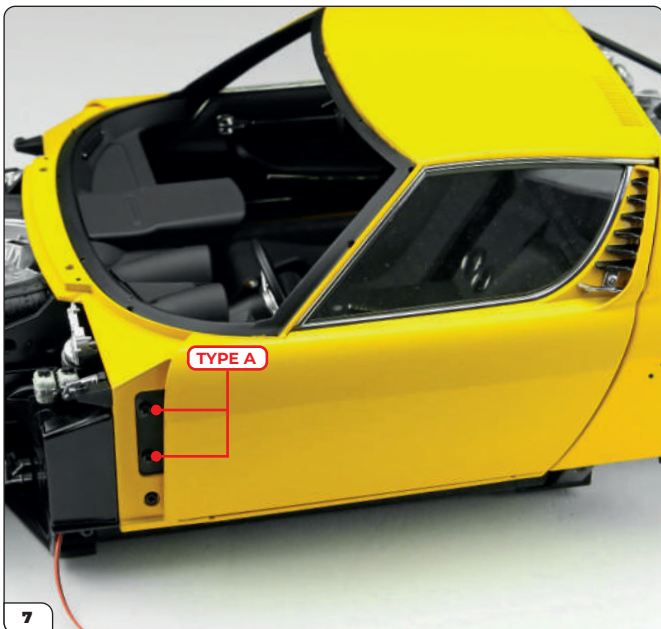

Fit the left door in place, and secure using 2x Type A screws (supplied with Stage 76). Tighten the screws once the door fits snug to the body.

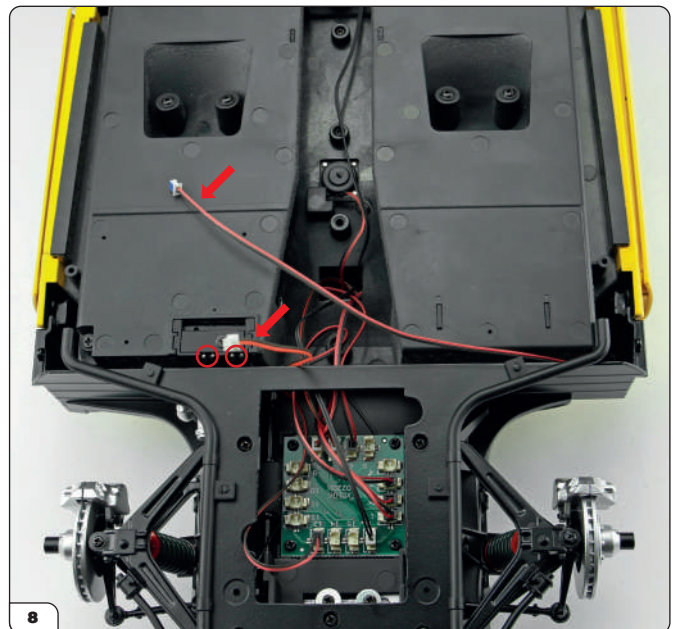

Carefully turn the assembly over. Take the cables coming from the doors (arrows) and lay them between the front frame and the cockpit as shown, then pass the plugs under the front cross member towards the circuit board. Take care not to damage the pedal connections (circled) as you lay the left-hand door wire in place.

Stage 79: Attaching the Left and Right Doors

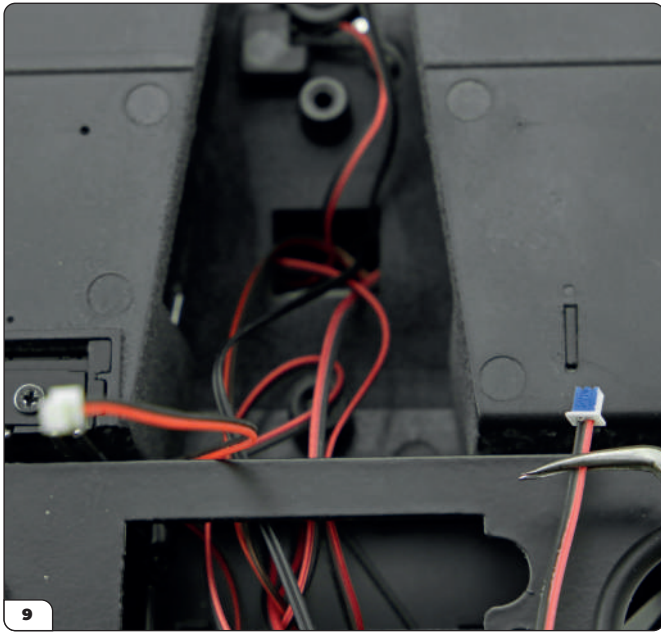

First take the right door switch with a white plug and blue panel.

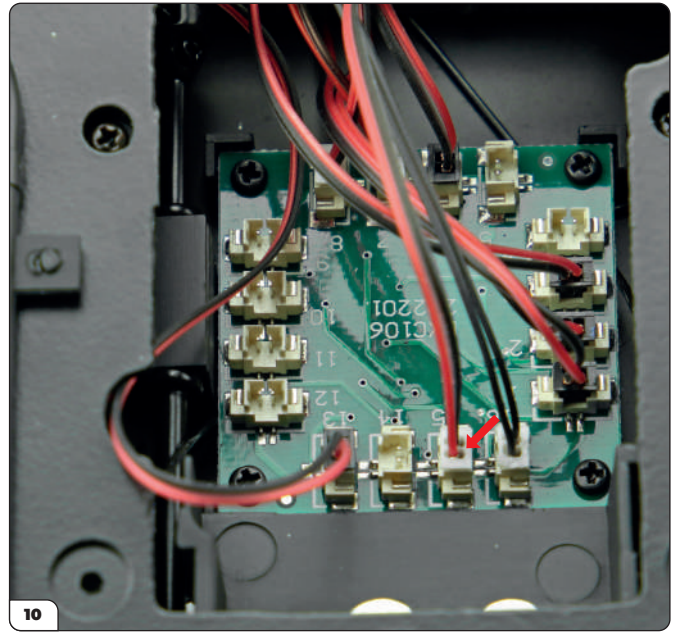

Plug the right door switch into connection 15 (arrow).

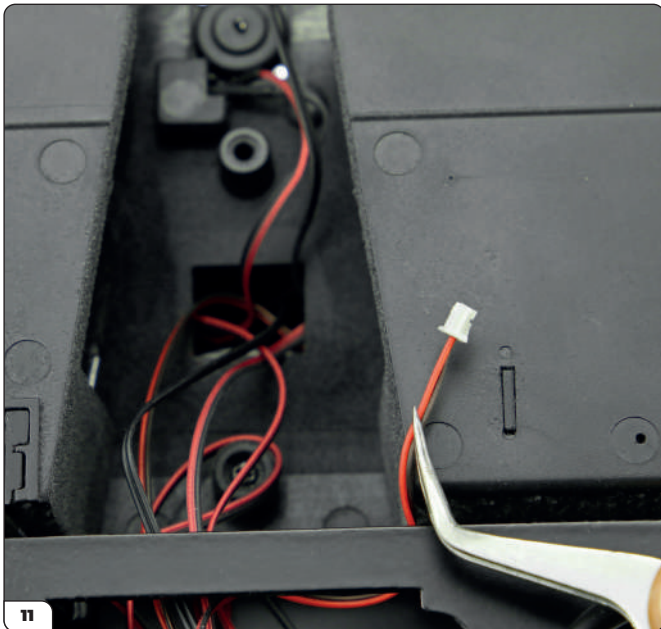

Take the plug of the left door switch, which is white (no panel colour).

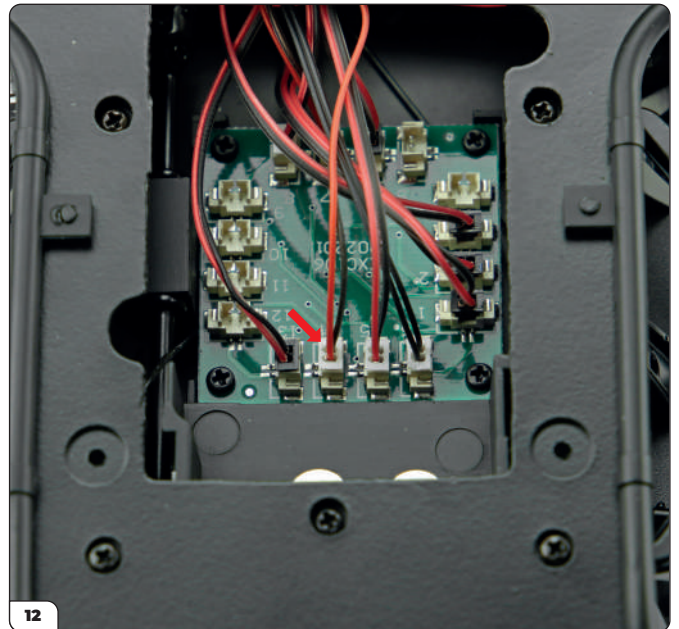

Plug the left door switch into connection 14 (arrow).

Stage 79: Attaching the Left and Right Doors

STAGE COMPLETE



Stage 80: Building the Bonnet Reinforcement Structure (1)

In this stage you are supplied with the beautiful front of the Miura's body. This will be fitted onto the model in a later stage, so store it away safely for now.

You'll need the parts supplied with Stage 77 to begin building the reinforcement structure for supporting the front body.



STAGE 80 PARTS LIST

Name
Front body
Type Q screws x3



Stage 80: Building the Bonnet Reinforcement Structure (1)

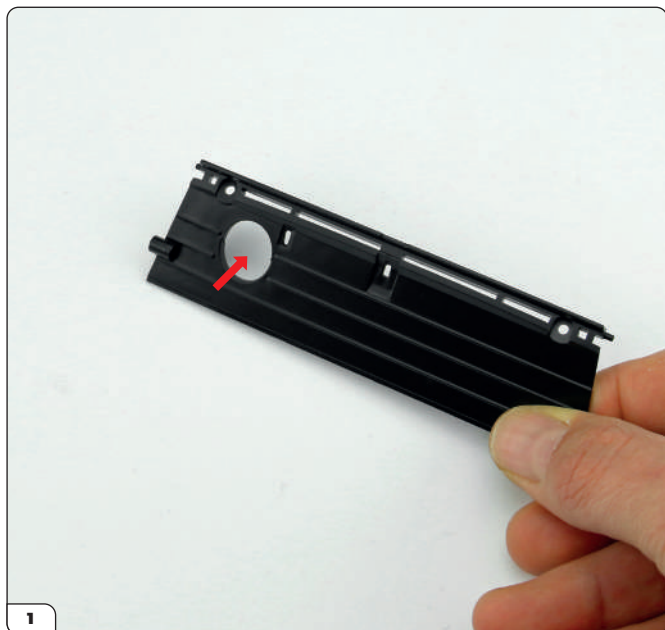

Take the bonnet inner bulkhead supplied with Stage 77. Note the large hole in the bulkhead for the plug of the tank.

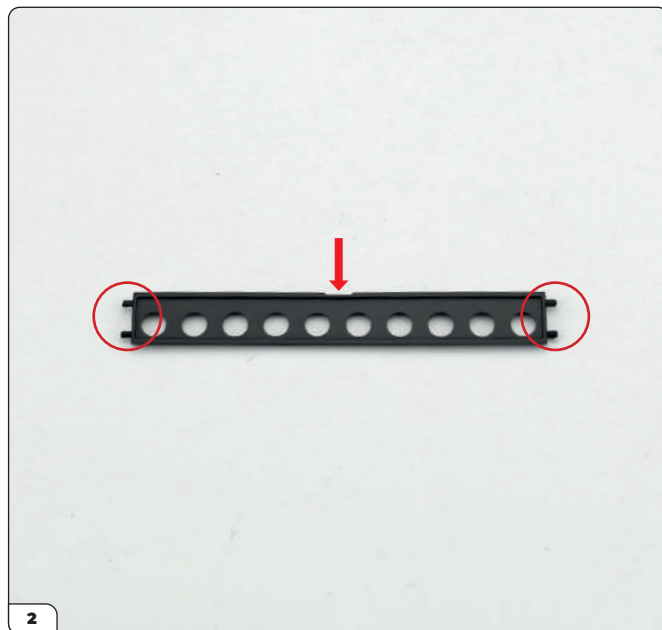

The bonnet central crossbar (supplied with Stage 77) has two pins at either end (circled) and a central recess (arrow).

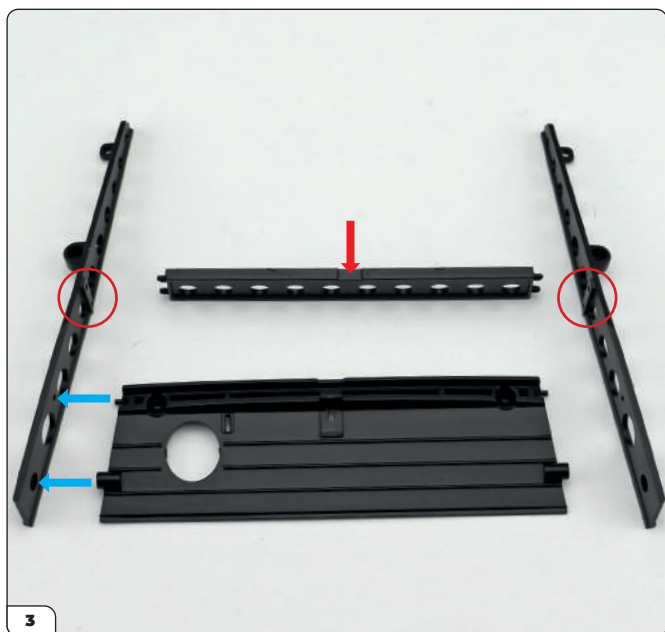

Place the bonnet inner bulkhead on your work surface, with the large hole on the left. Then place the bonnet central crossbar as shown, with the central recess oriented upwards (red arrow). Take the two bonnet side crossbars and align them with the other two pieces as shown, with the holes for the central crossbar pins facing inwards (circled). Note the small and large hole for fitting the inner bulkhead that correspond with the small pin and large column (blue arrows).



Press the pin and column of the inner bulkhead into the holes highlighted by the blue arrows in step 3.

Stage 80: Building the Bonnet Reinforcement Structure (1)



5 Drive a Type B screw (supplied with Stage 77) through the side crossbar and into the large column of the inner bulkhead.

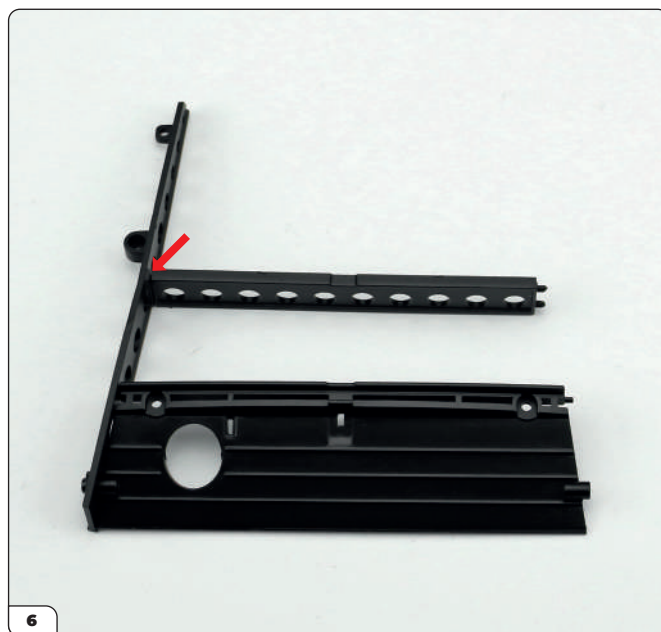

6 Press the pins of the central crossbar into the corresponding holes in the side crossbar (arrow). Ensure the central crossbar is oriented the correct way (see step 7).

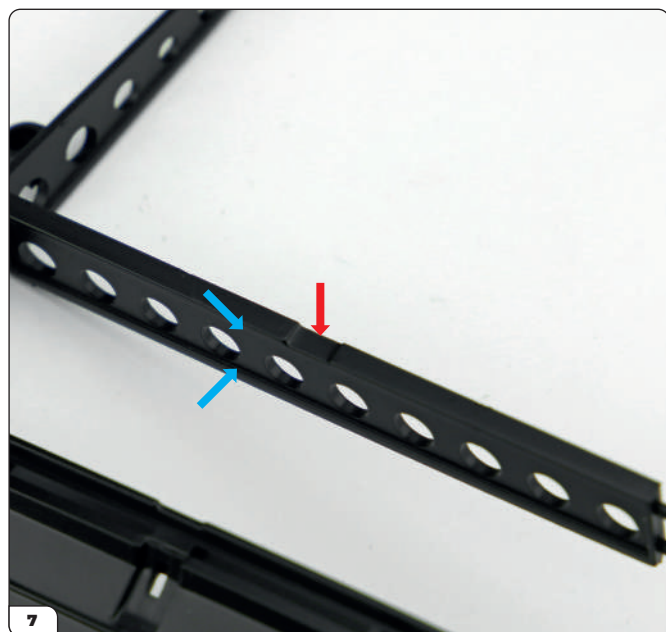

7 The recess of the central crossbar (red arrow) should face upwards, while the protruding edge (blue arrow) which runs around the length and height of the front should face towards the inner bulkhead.

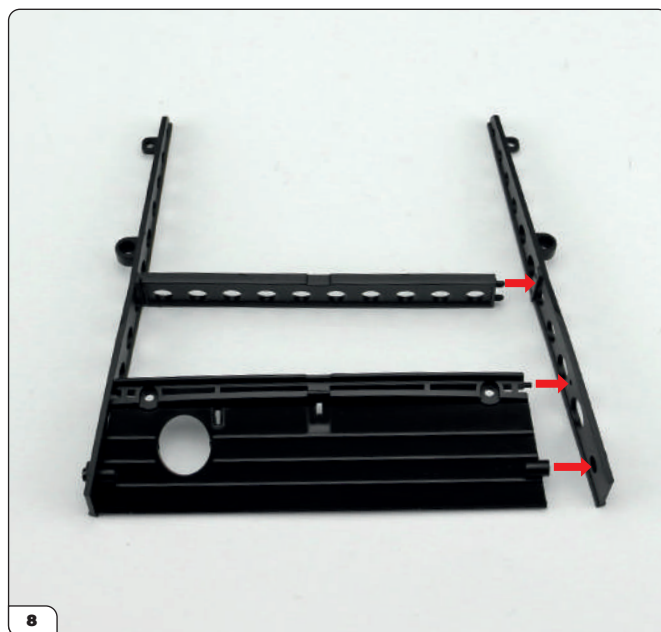

8 Align the other side crossbar with the assembly as shown, then press the pins and column into the side crossbar in the same manner as before (arrows).

Stage 80: Building the Bonnet Reinforcement Structure (1)



Drive a Type B screw into the column of the inner bulkhead to fix the parts together.

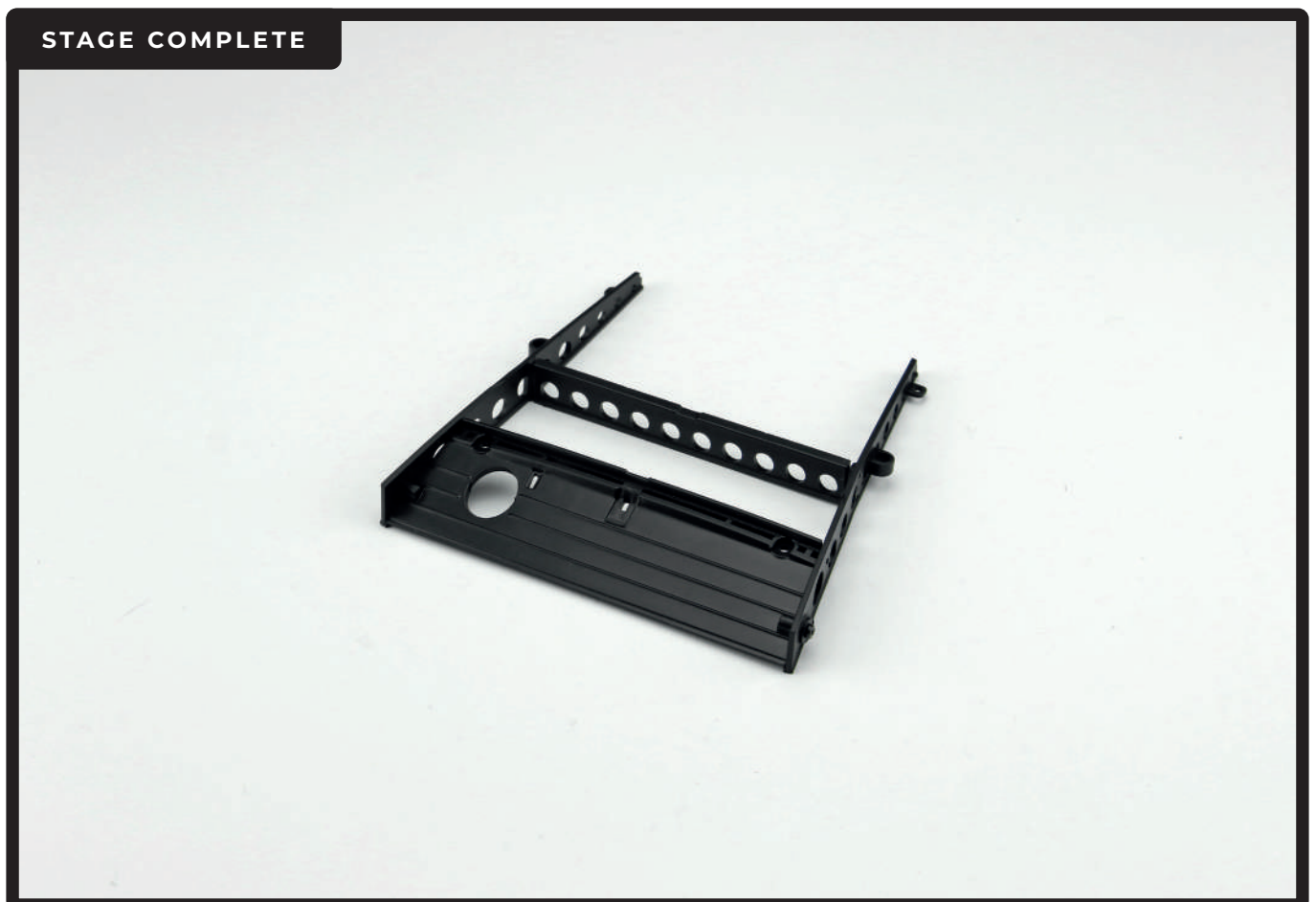

Stage 81: Building the Bonnet Reinforcement Structure (2)

You'll continue to assemble the reinforcement structure using the parts supplied with Stage 78.

The bag of parts supplied with this stage can be kept in a safe place until they are needed in a later stage.



STAGE 81 PARTS LIST

Name
Bonnet support bracket x2
Internal frame detail
Rear bonnet hinge x2
Bonnet grille support
Front bonnet hinge x2
Type S screws x2
Type A screws x3
Type G screws x5

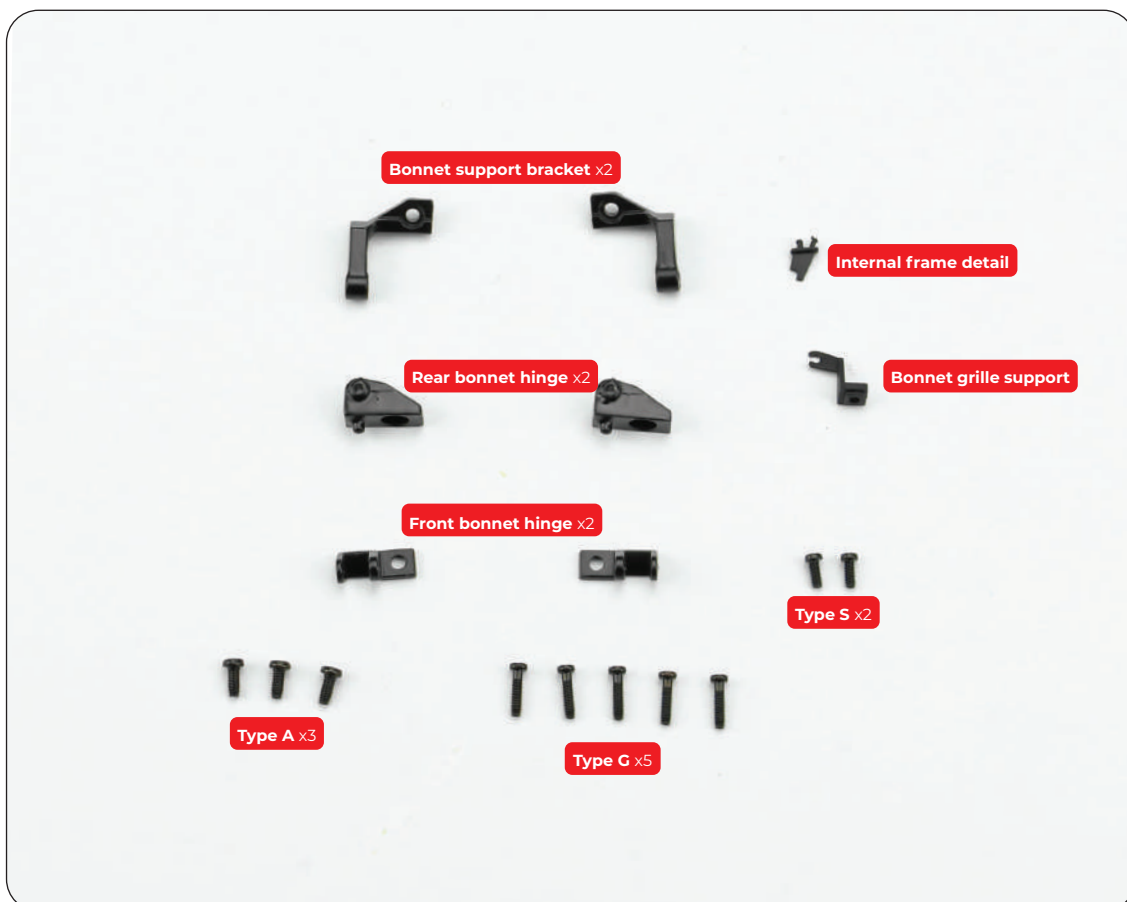

Stage 81: Building the Bonnet Reinforcement Structure (2)

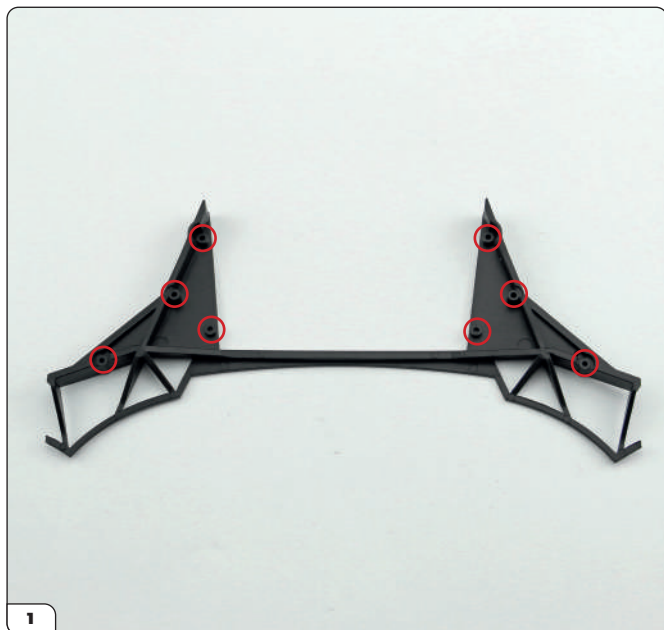

Take the bonnet reinforcement frame (supplied with Stage 78) and place it on your work surface with the screw columns (circled) facing upwards as shown.

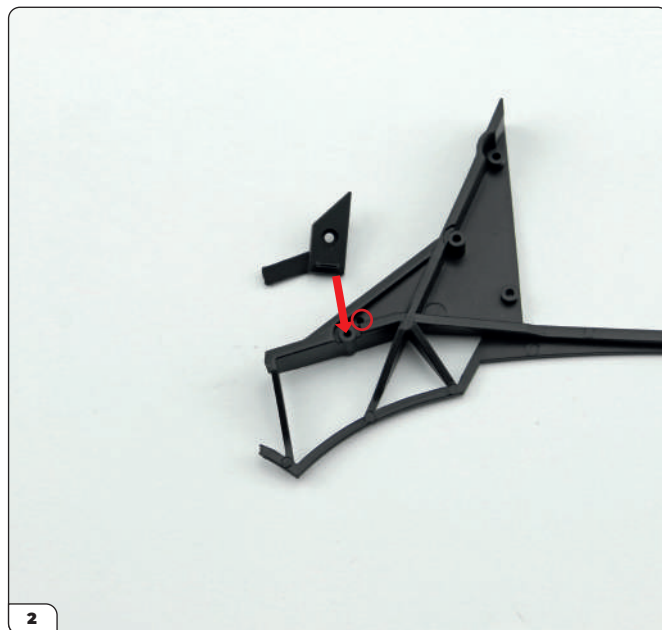

Take the left support (supplied with Stage 78) and align it with the frame as shown. The support fits into the leftmost column (arrow), while the pin on the back of the support fits into the small hole located next to the column (circled).

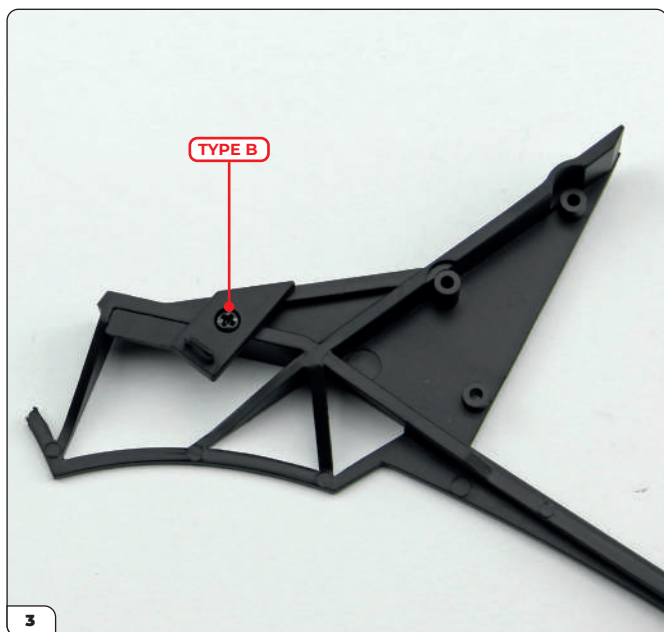

Press the support into the frame and secure it using a Type B screw. Make sure the screw is flush with the support.

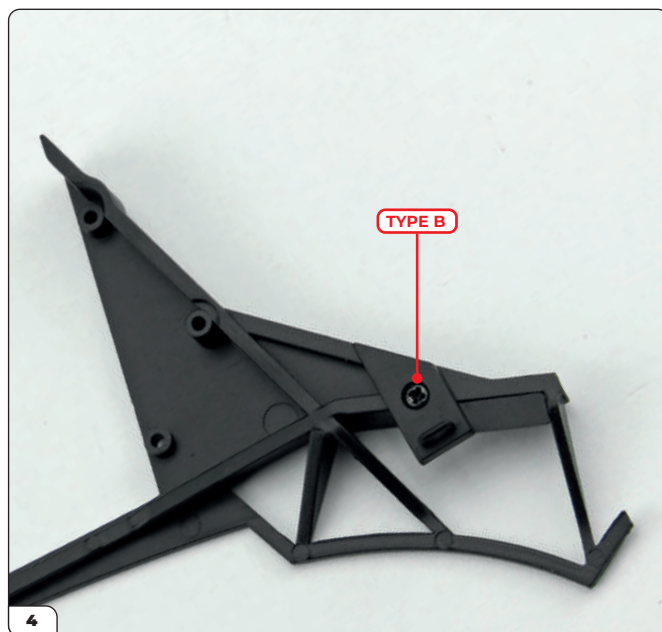

Fit the right support into the other side of the frame in the same manner and secure it using a Type B screw, making sure it is flush.

Stage 81: Building the Bonnet Reinforcement Structure (2)

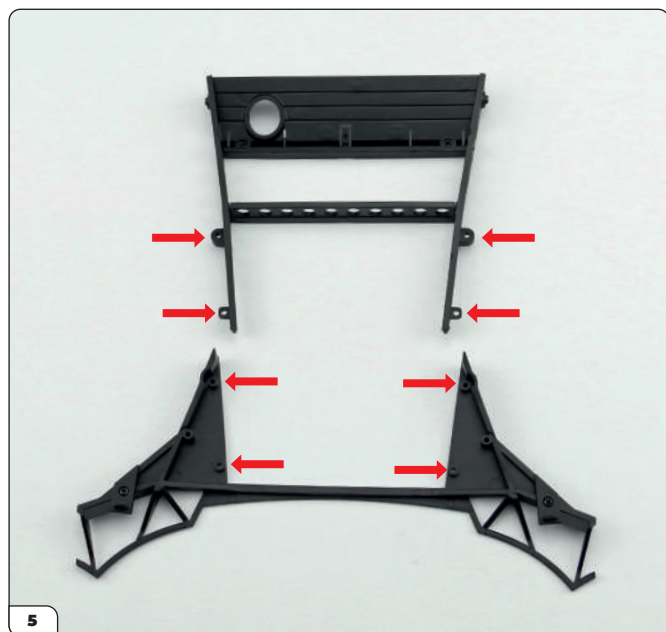

5
Retrieve the first part of the reinforcement structure assembled in Stage 80. Align the two parts as shown and identify the fixing points shown by the arrows.

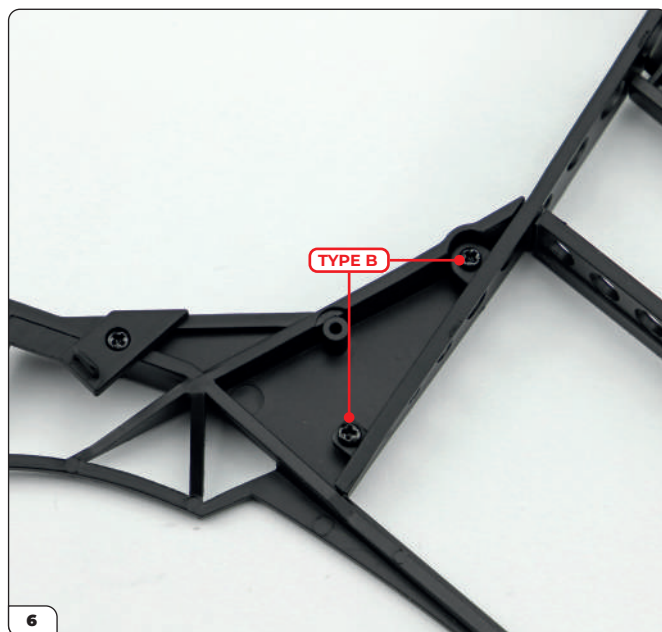

6
Fit the two parts of the structure together using the points identified in the previous step. Once in place, use 2x Type B screws (supplied with Stage 78) to secure one side of the structure.

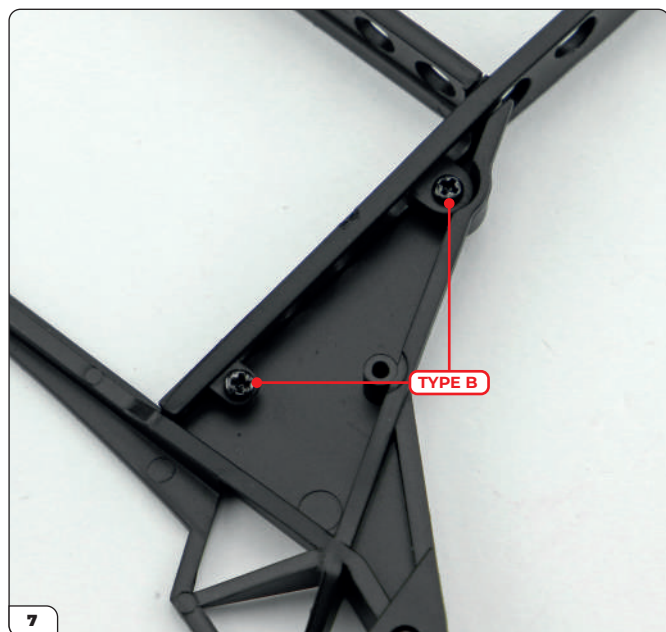

7
Use 2x Type B screws (supplied with Stage 78) to secure the other side.

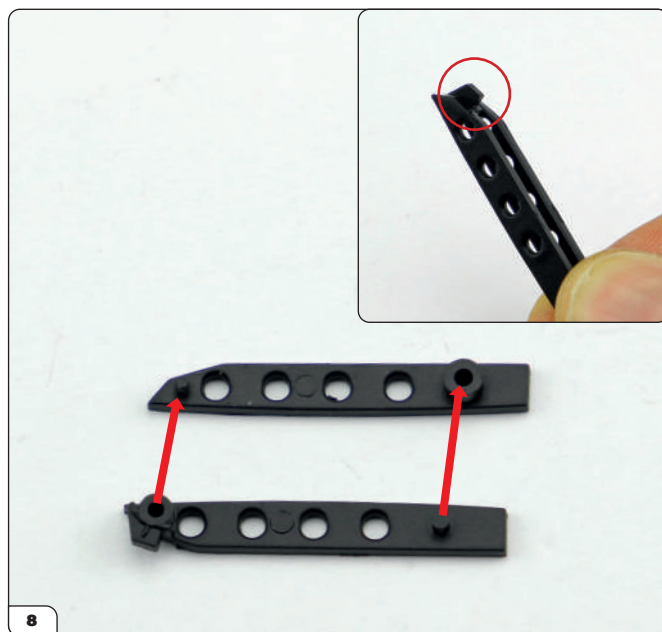

8
Take the right and left perforated plates (supplied with Stage 78) and press them together, using the pins and columns (arrows). Note the pin at the end of the perforated plates (inset, circled).

Stage 81: Building the Bonnet Reinforcement Structure (2)



Lay the structure assembly on your work surface as shown. The pin of the perforated plates fits into the rectangular hole in the middle of the inner bulkhead (arrow).



Press the pin of the plates into the inner bulkhead as shown.

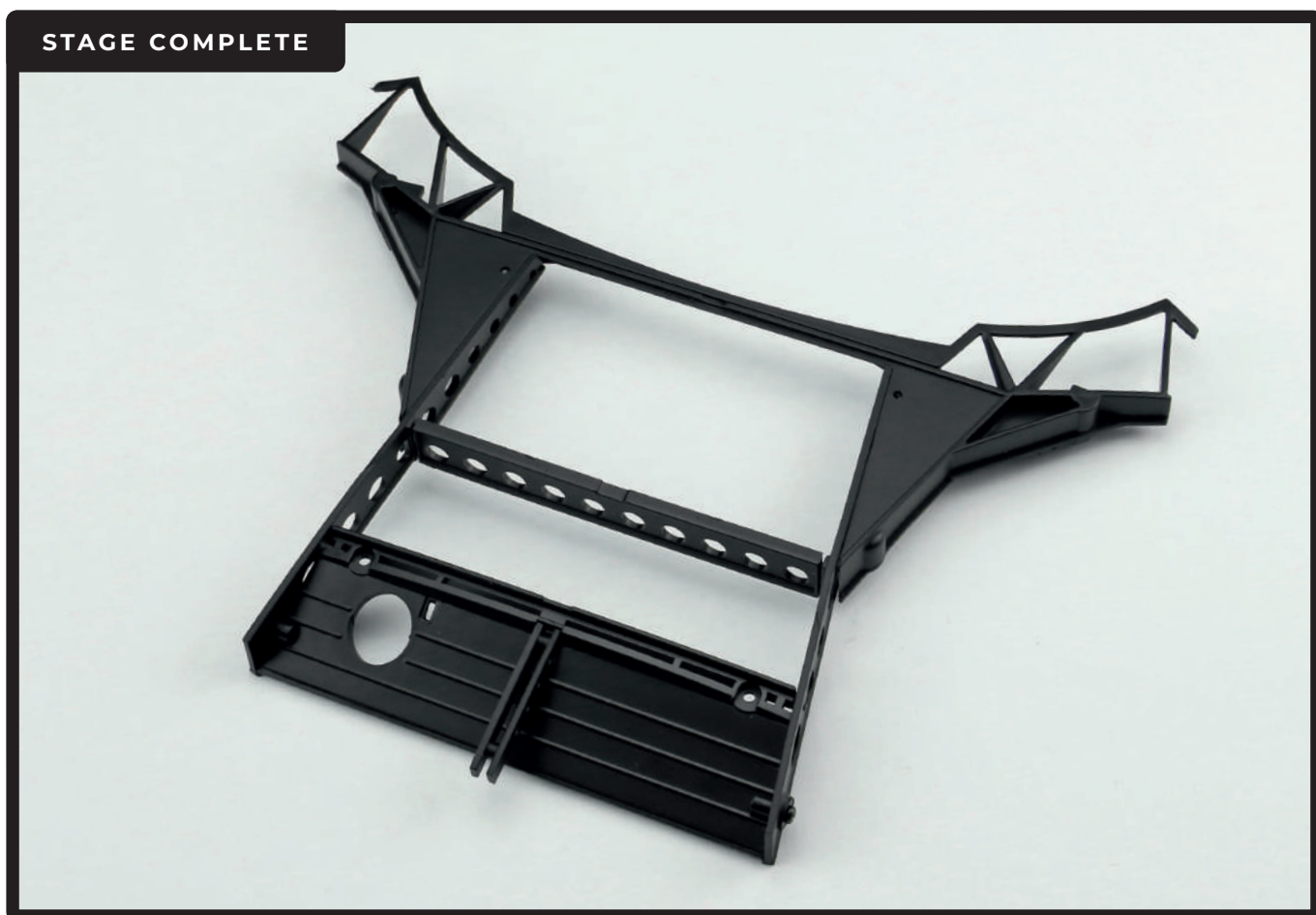

Stage 82: Assembling the Headlights

For the last stage of this Pack, you'll assemble the headlights for your model using the pieces supplied with Stage 79.

The bag of parts supplied with this stage can be kept in a safe place until they are needed in a later stage.



STAGE 82 PARTS LIST

Name
Left front wheel arch
Left front fog light lens
Left front fog light body
Left front indicator



Stage 82: Assembling the Headlights

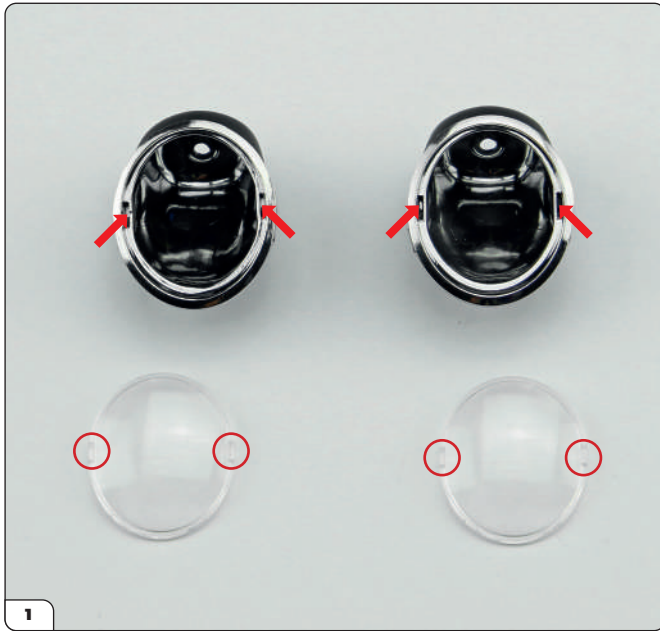

Take the headlight lenses and bodies (supplied with Stage 79) and place them on your work surface as shown. The lenses have two plugs on their sides (circled) which correspond with the slots in the sides of the housings (arrows). These are identical and may be used as either the left or right headlight once assembled.



Press one of the lenses into the headlight housings as shown. Note the orientation of the pattern on the lens (arrow).



Take one of the headlight LEDs (supplied with Stage 79) and insert the bulb end into the hole at the back of the housing (inset). The fit may be tight, we recommend holding behind the bulb with a pair of tweezers to firmly press it into place.



Fit the remaining headlight LED into the back of the other housing. The headlights are now ready to be mounted onto the support.

Stage 82: Assembling the Headlights

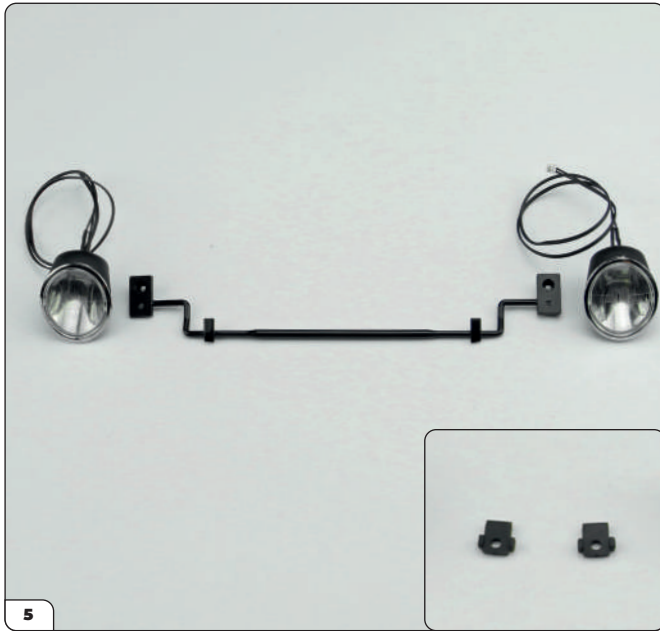

Place the headlight support (supplied with Stage 79) on your work surface, then align the two headlights with it as shown.

The small support plates (inset) that are supplied in the same bag as the headlight support will be used in a later Pack, keep them in a safe place until they are needed.

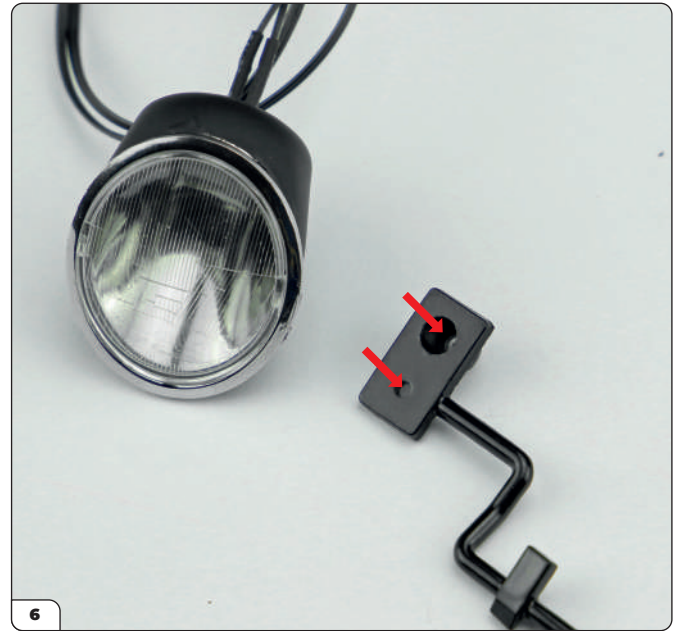

Each end of the support has a bracket with a small and large hole (arrows) for mounting the headlight.



Mount one of the headlights onto one end of the support, then secure it using a Type B screw (supplied with Stage 79).



Mount the other headlight in the same manner and secure it using a Type B screw.

Stage 82: Assembling the Headlights

