



# Lamborghini MIURA



## Pack 05

### BUILD INSTRUCTIONS

**STAGE 34: FITTING THE RIGHT  
REAR BRAKE DISC**

**STAGE 35: INSTALLING THE  
COOLANT AUXILIARY RESERVOIR**

**STAGE 36: ATTACHING THE ANTI-ROLL BAR**

**STAGE 37: ASSEMBLING A REAR TYRE**

**STAGE 38: PREPARING THE TRANSMISSION  
TUNNEL REAR PANEL**

**STAGE 39: FITTING THE PASSENGER  
FOOTREST AND MAT TO THE COCKPIT FLOOR**

**STAGE 40: ADDING THE SIDE COVER AND AIR  
VENTS TO THE TRANSMISSION TUNNEL**

**STAGE 41: FITTING THE HEADRESTS  
AND DRIVER'S SIDE DETAILS**

**STAGE 42: INSTALLING THE CENTRAL  
CONSOLE AND REAR PANEL**

The "Automobili Lamborghini" and "Automobili Lamborghini Bull and Shield" trademarks, copyrights, designs and models are used under license from Automobile Lamborghini S.p.A, Italy.

## Advice from the experts

---

Spare screws are included with each part. Occasionally, you may be instructed to keep spare or unused screws for a later stage. Keep these spares in a safe place and label them correctly.

Please make sure you don't mix up the screws. They look quite similar, but the threads do vary slightly. Using the wrong screws may damage the parts.

When securing parts together using multiple screws, fit each screw loosely to ensure all the parts are correctly aligned before gently tightening them firmly, but not overtight, in the order in which you placed them.

The screwdriver can be magnetized by stroking it with a magnet (fridge magnet, etc.) enabling it to hold the screws and make assembly easier.

If a screw is tight going into a metal part, do not force it as you may shear the head off. Remove it and put a tiny smear of Vaseline, soap or light oil on the thread. That will lubricate it and make it easier to drive home.

During the course of this build, you will receive many pieces that you will assemble immediately – following the instructions in the corresponding stage – and other pieces that you should store safely to one side, for use in future assembly stages.

Left and Right! When building your Lamborghini, the left or right hand side refers to each side as you are sitting in the car.



**WARNING:** Some parts are assembled using magnets. These magnets can cause serious injury if they are swallowed. Keep away from children. If you suspect a magnet has been swallowed, seek medical help straight away.

## Stage 34: Fitting the Right Rear Brake Disc

For the first stage of this Pack, you'll fit the right rear brake discs onto its wheel hub. Take care with their parts, as there is a fragile metal pin on the inner brake caliper.



### STAGE 34 PARTS LIST

| Name                                  |
|---------------------------------------|
| Right rear brake disc (inner)         |
| Right rear brake disc (outer)         |
| Right rear brake disc caliper (inner) |
| Right rear brake disc caliper (outer) |

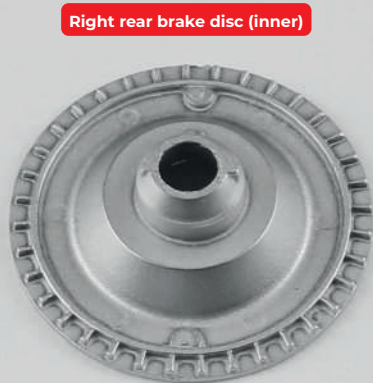

## Stage 34: Fitting the Right Rear Brake Disc

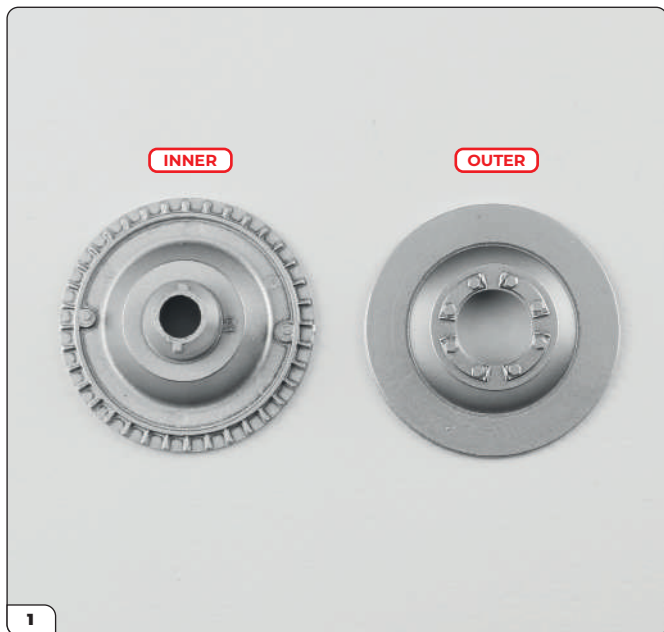

The right rear brake disc is made up of two sides. The inner side will face towards the model while the outer will face away from it. You can distinguish the two parts with the help of the image above.

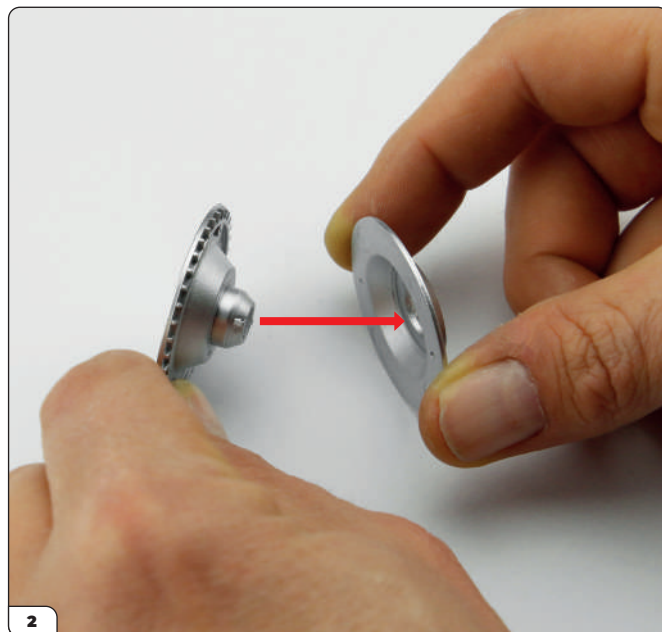

Take the inner disc and insert it into the outer disc as shown. Squeeze both parts together firmly all the way around until the fit is flush.



These images show how the brake disc looks fitted together from the side (left) and from above (right).



The right rear brake caliper also consists of an inner and outer part. Lay them on your work surface as shown to distinguish the two parts from each other.

## Stage 34: Fitting the Right Rear Brake Disc

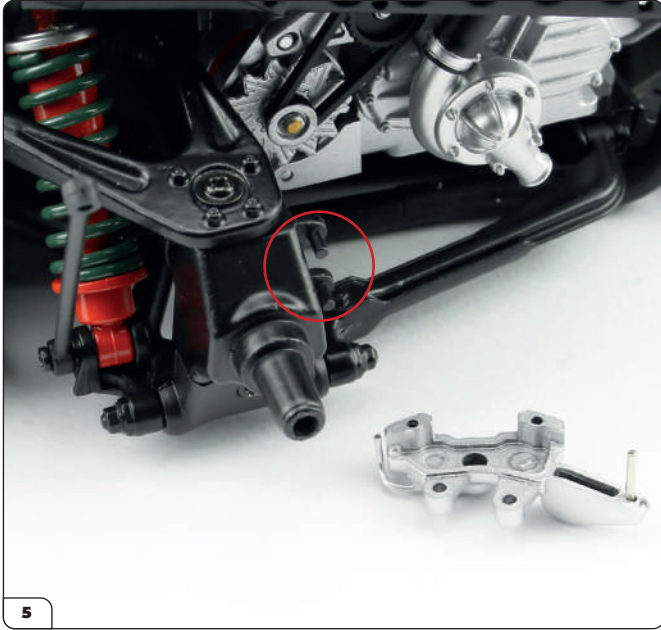

Place the rear frame assembly on your work surface. The inner part of the caliper will fit onto the two pins located next to the left rear wheel hub (circled).

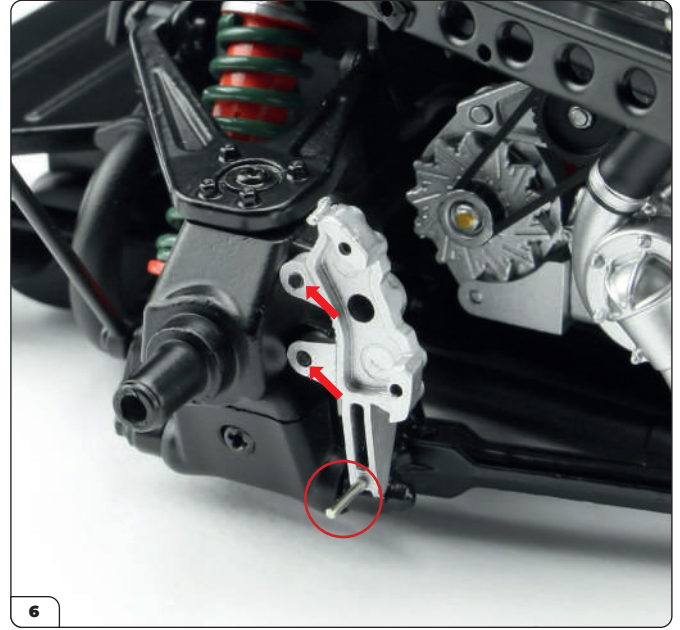

Orient the inner caliper as shown and press it onto the two pins (arrows). Take care not to apply any pressure to the thin metal pin (circled) while fitting the part in place. If necessary, carefully file away some of the paint on the pins for a better fit.

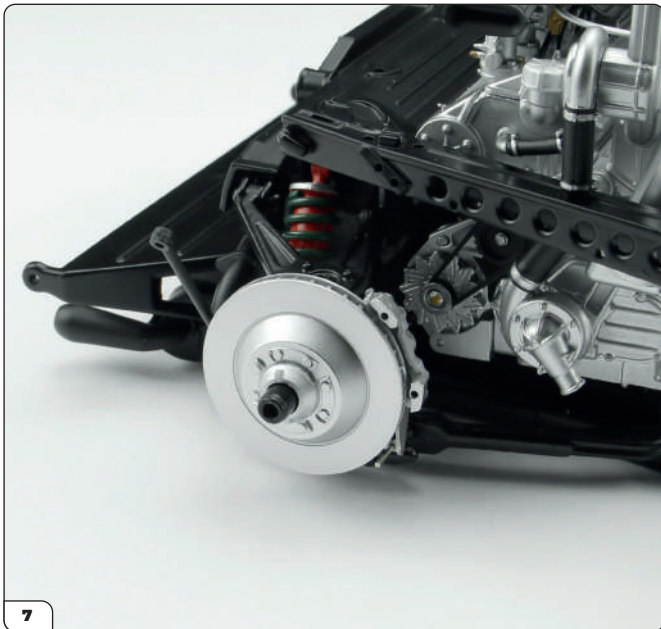

Fit the brake disc onto the wheel hub as shown.

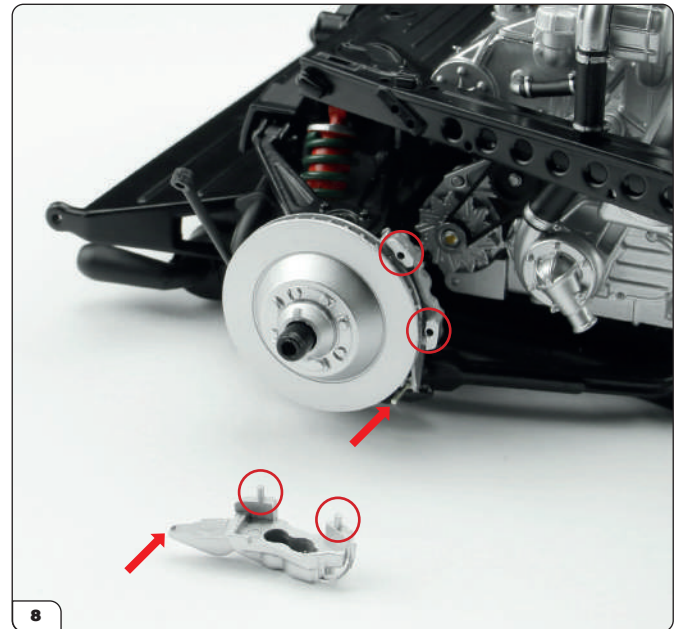

Next the outer part of the caliper will be fitted. Note the two mounting pins (circled) and the recess (arrow) that correspond with the two holes and thin metal pin of the inner caliper visible in step 7.

## Stage 34: Fitting the Right Rear Brake Disc

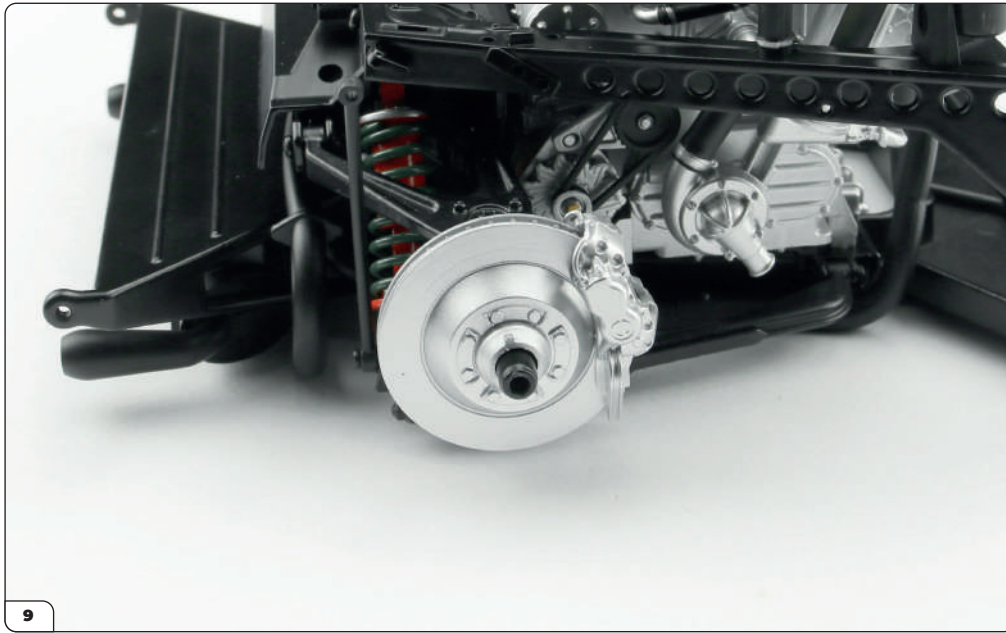

Carefully fit the outer caliper onto the inner caliper and lightly press the parts together.

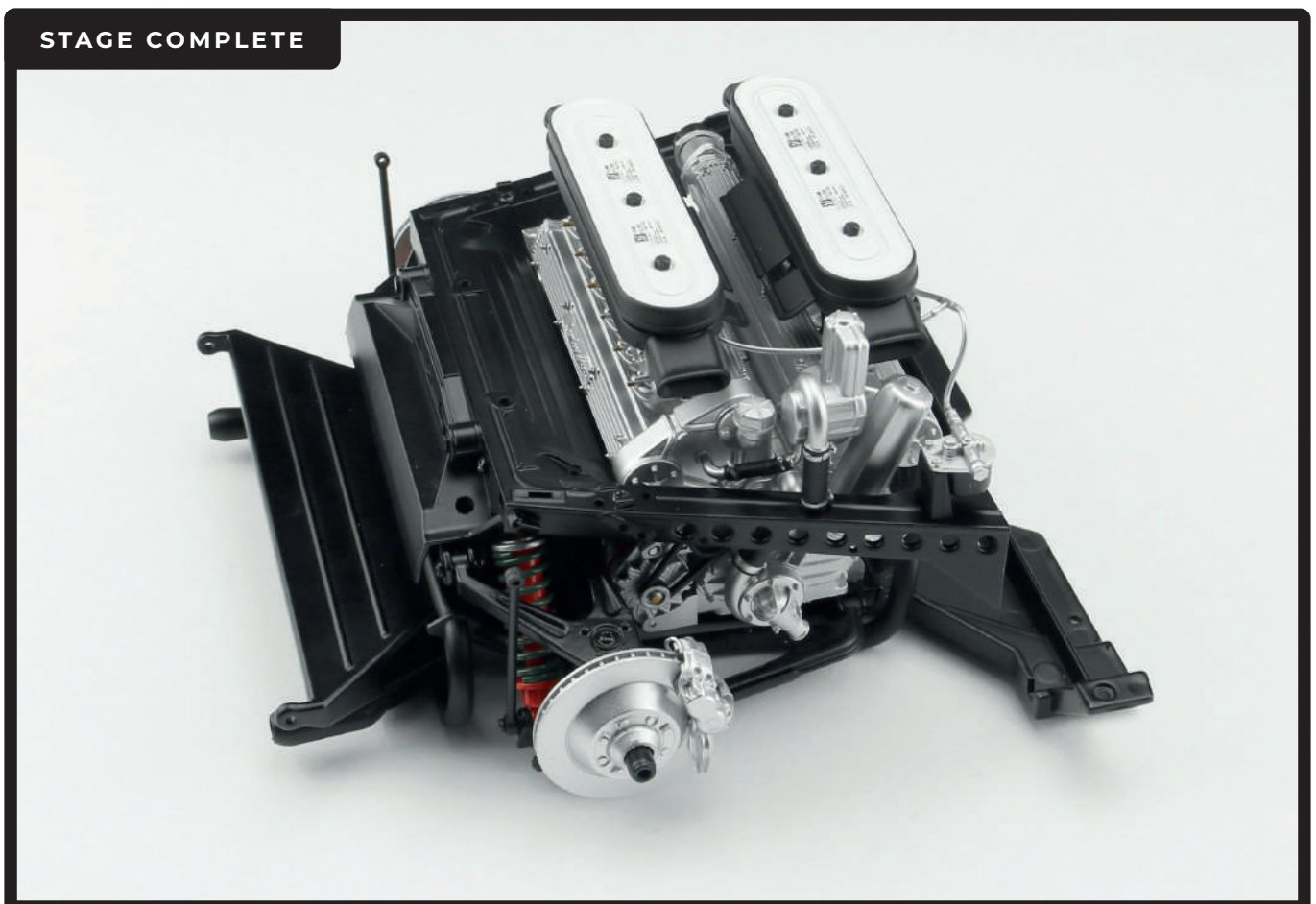

## Stage 35: Installing the Coolant Auxiliary Reservoir

In this stage you'll install the coolant auxiliary reservoir, which stores the liquid pumped into the engine blocks and keeps them cool.



### STAGE 35 PARTS LIST

| Name                                |
|-------------------------------------|
| Coolant auxiliary reservoir (back)  |
| Coolant auxiliary reservoir (front) |
| Horizontal pipe                     |
| Fitting                             |
| Vertical pipe                       |



## Stage 35: Installing the Coolant Auxiliary Reservoir



1

The coolant auxiliary reservoir has a front piece with two posts (top image) and a back piece with two corresponding holes (bottom image).



2

Align the two pieces of the coolant reservoir as shown, then press them firmly together. The inset image shows how the tank should look once assembled.

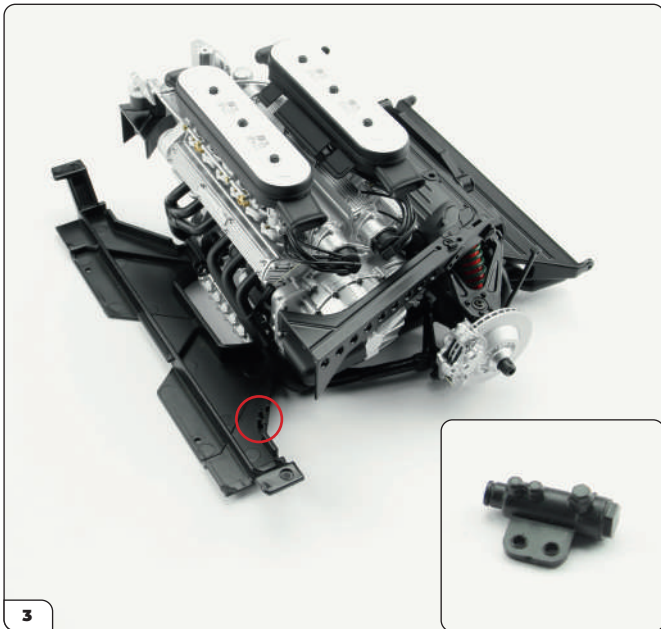

3

Place the rear frame assembly on your work surface. Locate the two fixing pins (circled) which will be used for attaching the fitting (inset).

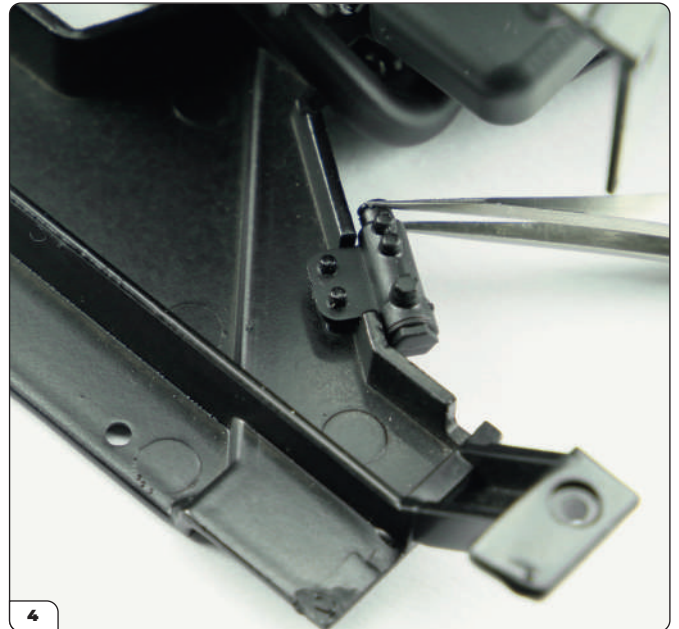

4

Take the fitting and firmly press the tab with two holes onto the two pins identified in the previous step, orienting it as shown.



## Stage 35: Installing the Coolant Auxiliary Reservoir

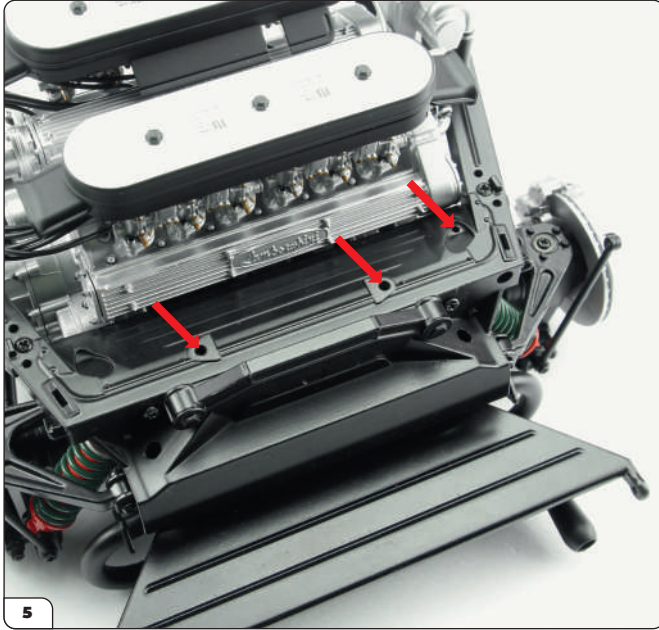

Turn the frame assembly around to the rear end, then locate the three mounting holes for the coolant auxiliary reservoir (arrows).

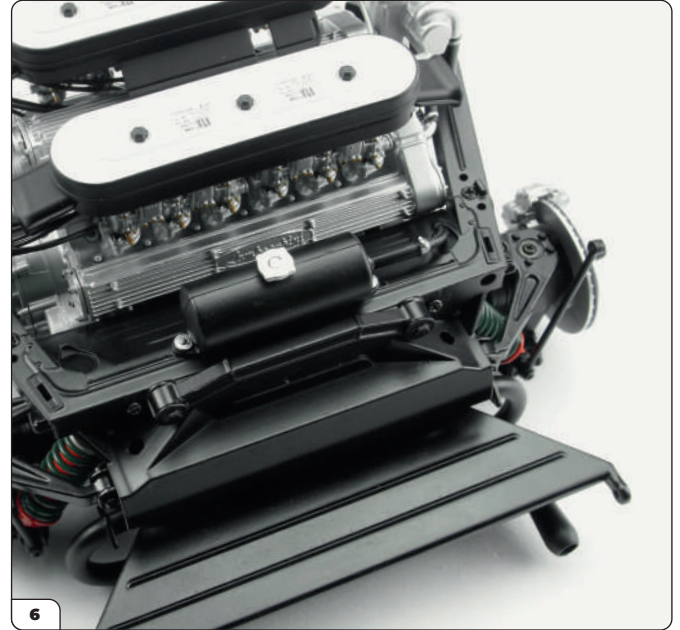

Fit the coolant auxiliary reservoir onto the rear frame by pressing its pins firmly into the holes indicated in the previous step. You may need to file some excess paint from the pins to get a good fit.

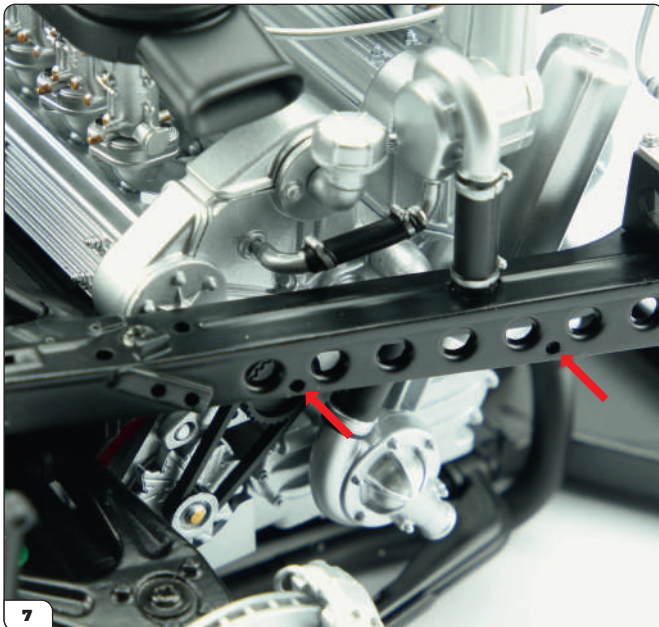

On the right side of the frame, locate the two holes for mounting the horizontal pipe (red arrows).

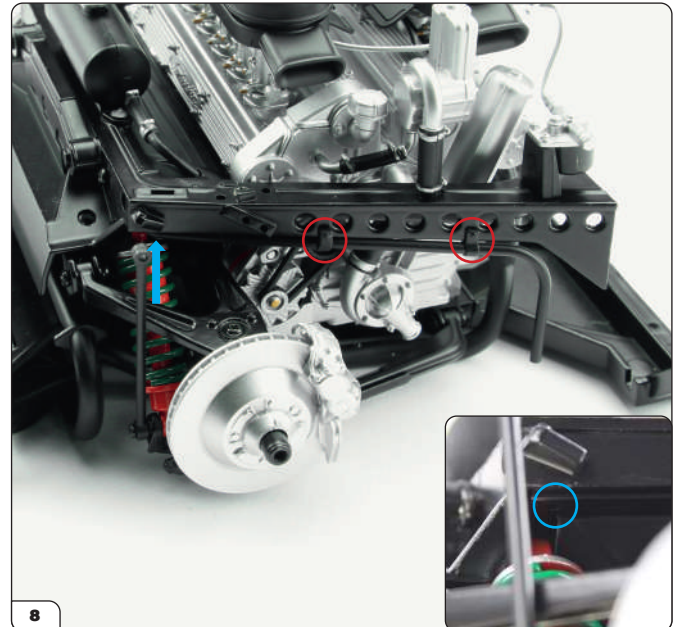

Insert the pins of the horizontal pipe into the holes in the side of the frame (circled). At the same time, fit the pin at the end of the pipe into the hole located under the frame (blue arrow). The inset image shows the hole circled in blue.

## Stage 35: Installing the Coolant Auxiliary Reservoir

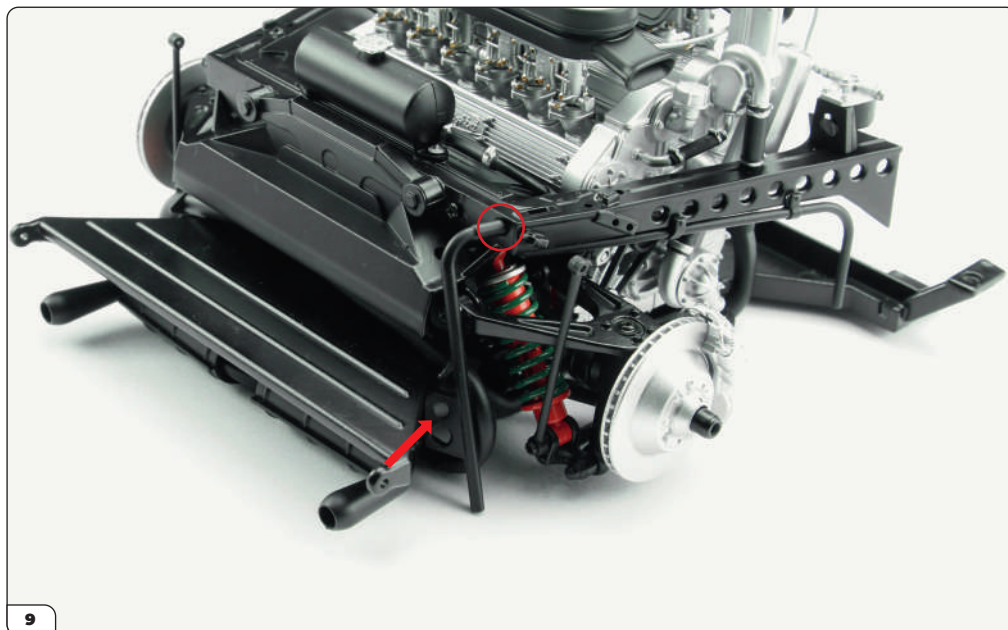

On the right rear corner of the frame there is a hole (circled). Take the vertical tube and push the thicker end of it hard into the hole. The perforated plate of the pipe should be oriented as shown (arrow).

**STAGE COMPLETE**

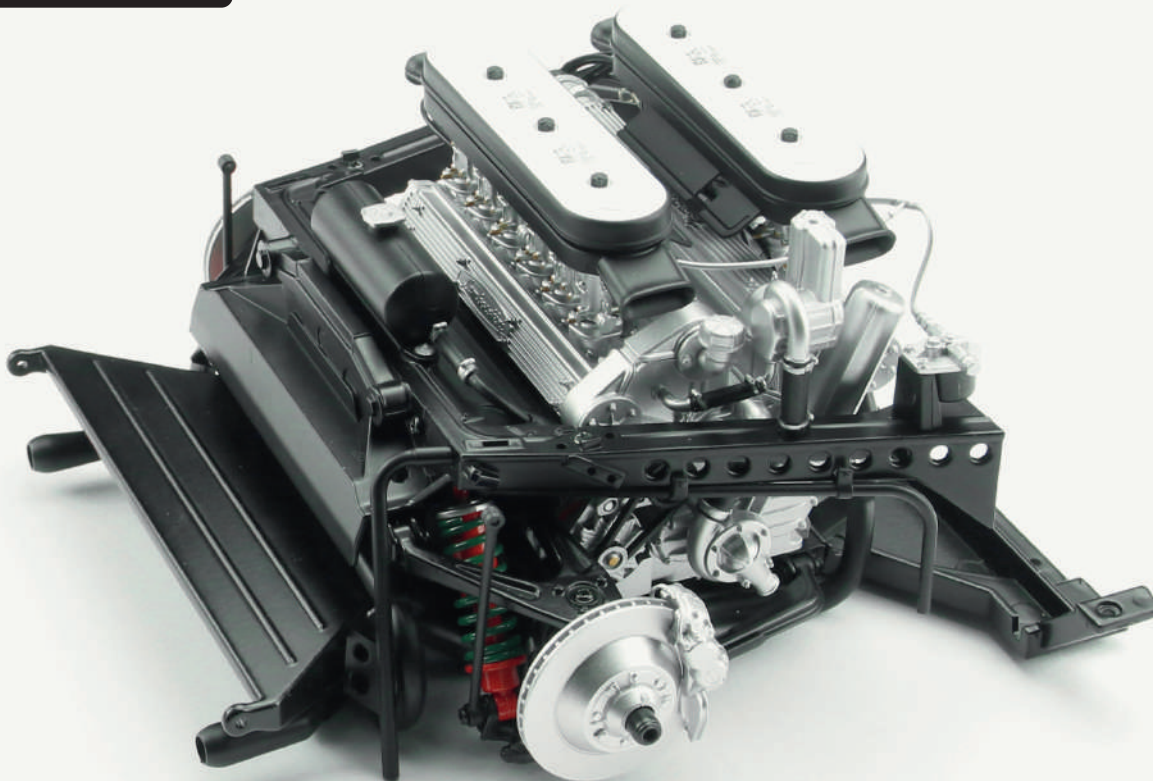

## Stage 36: Attaching the Anti-roll Bar

Next the anti-roll bar will be fitted by attaching it to the tie rods on the suspension.



### STAGE 36 PARTS LIST

| Name                          |
|-------------------------------|
| Left tie rod                  |
| Right tie rod                 |
| Anti-roll bar brackets        |
| Rear suspension anti-roll bar |

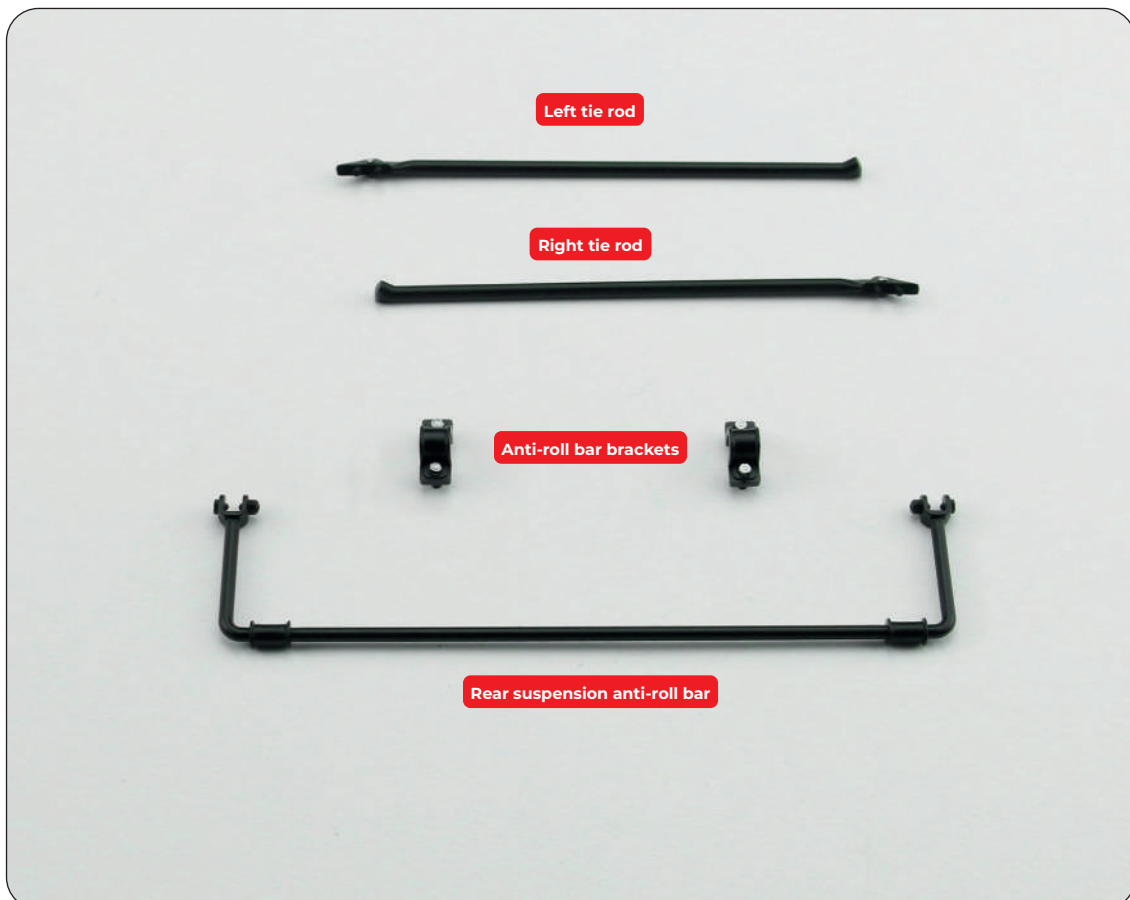

## Stage 36: Attaching the Anti-roll Bar

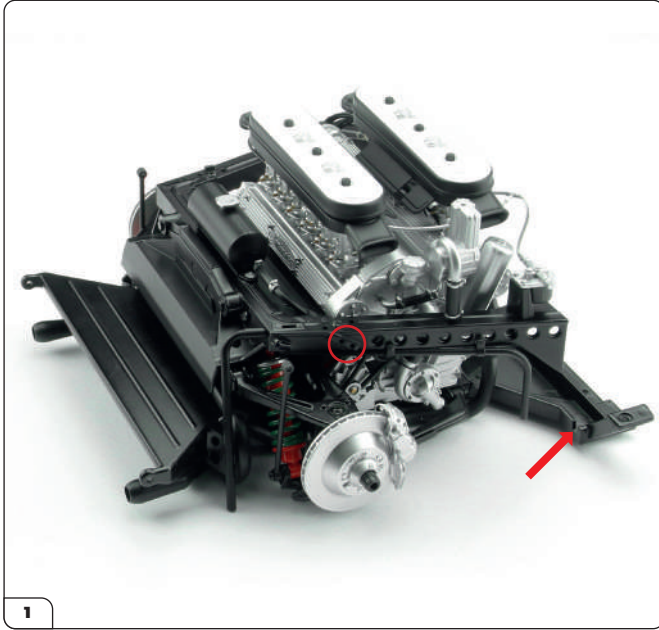

1 Place the rear frame assembly on the work surface as shown, with the right-hand side facing you. Locate the two holes (circled) on the edge of the frame and the U-shaped recess (arrow) for mounting the right tie rod.

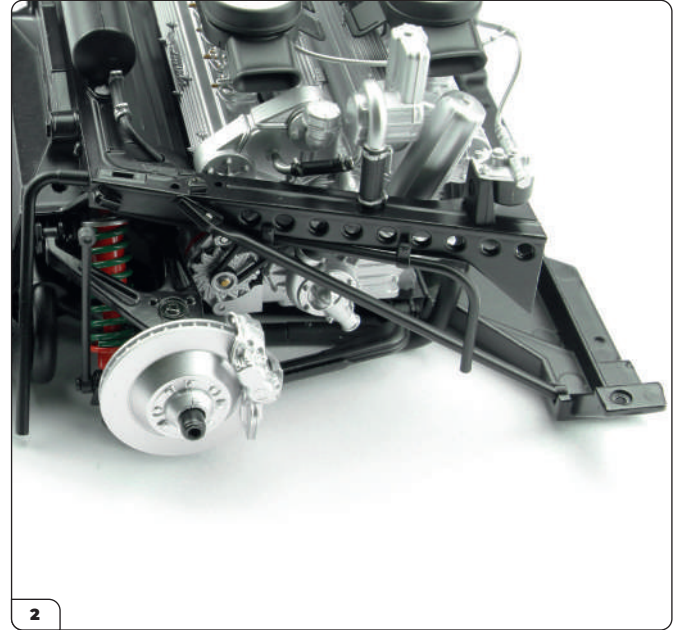

2 Fit the end of the right tie rod into the recess (arrow) then push the two pins at the other end of the rod into the holes highlighted in the previous step.



3 The two images above show the connection points for the right tie rod. Make sure the two pins are fully pressed into the holes in the frame.

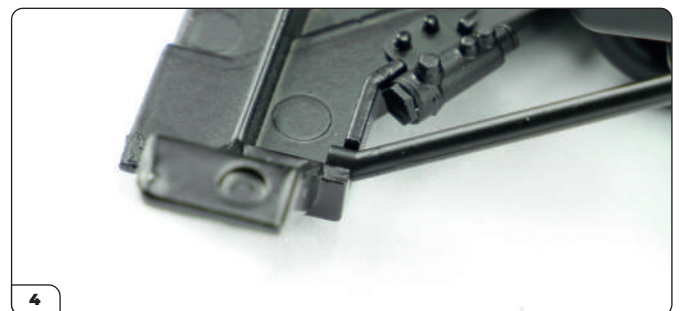

4 On the other side of the rear frame, install the left tie rod in the same manner. The images show the connection points, which are identical to the right tie rod.

## Stage 36: Attaching the Anti-roll Bar

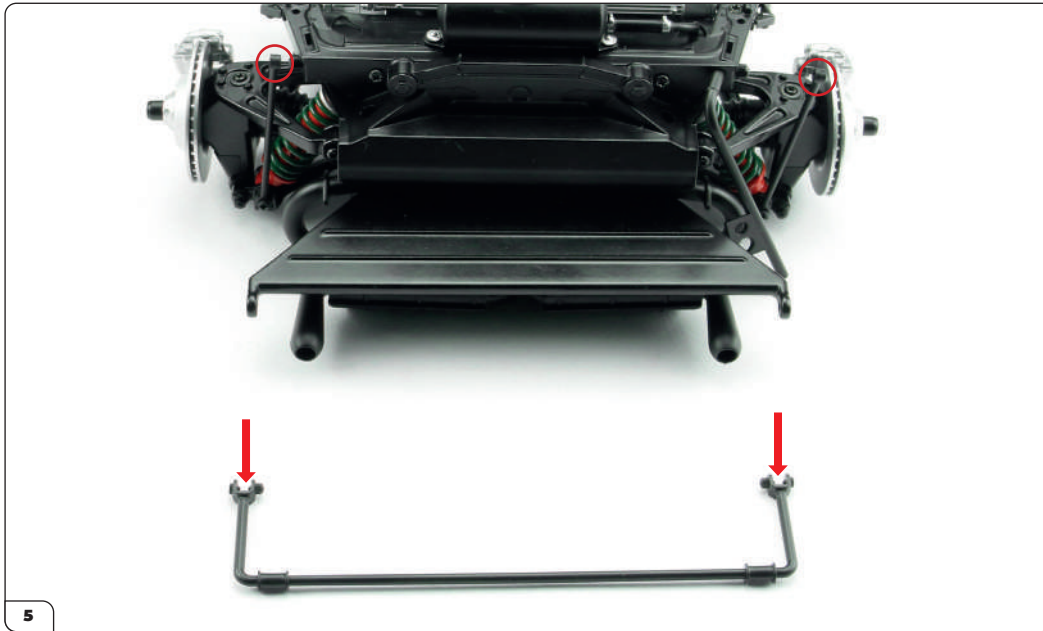

Next you'll attach the anti-roll bar. The bracket ends of the bar fit over the two eyelets from the tie rods installed in stages 26 and 27 (circled).

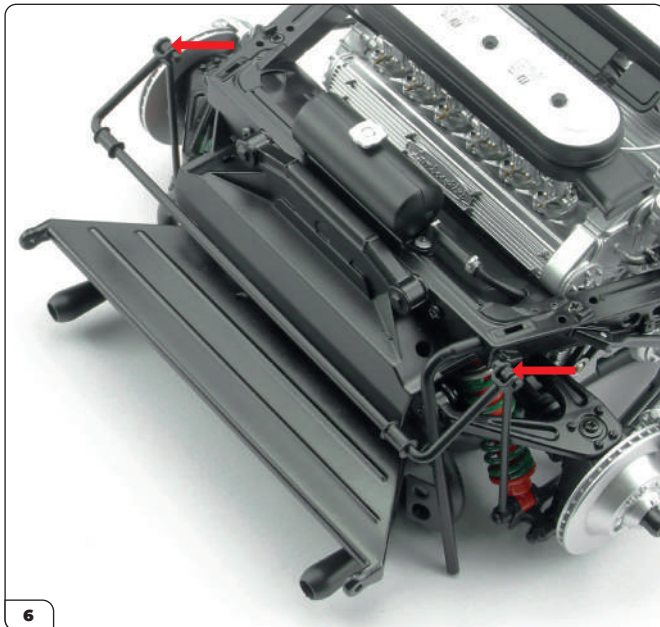

Firmly press each bracket end of the anti-roll bar over the eyelets of the tie rods as shown (arrows).

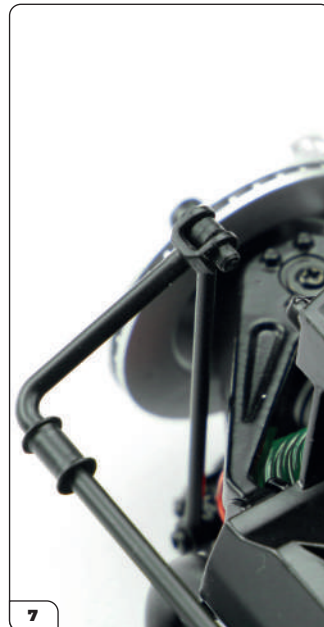

Both sides of the bar's brackets should snap into the holes of the eyelets. These can be difficult to fit – try carefully and gently prying the bracket apart to fit, then squeezing them with flat-nosed pliers once they are in place..

## Stage 36: Attaching the Anti-roll Bar

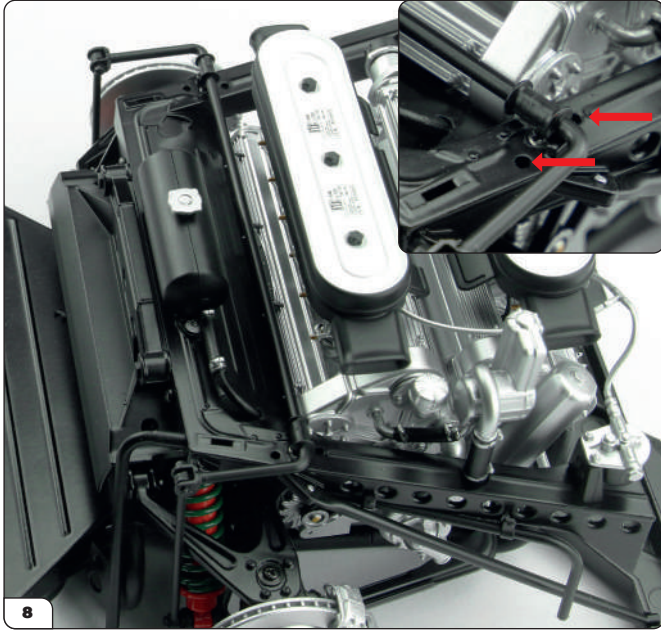

Rotate the anti-roll bar so that it is resting on the frame as shown. The thick sections should sit between the pair of holes on top of the frame (inset, arrows).



Press the two anti-roll bar brackets into the holes in the frame and over the thick sections of the bar to hold it in place.



**STAGE COMPLETE**

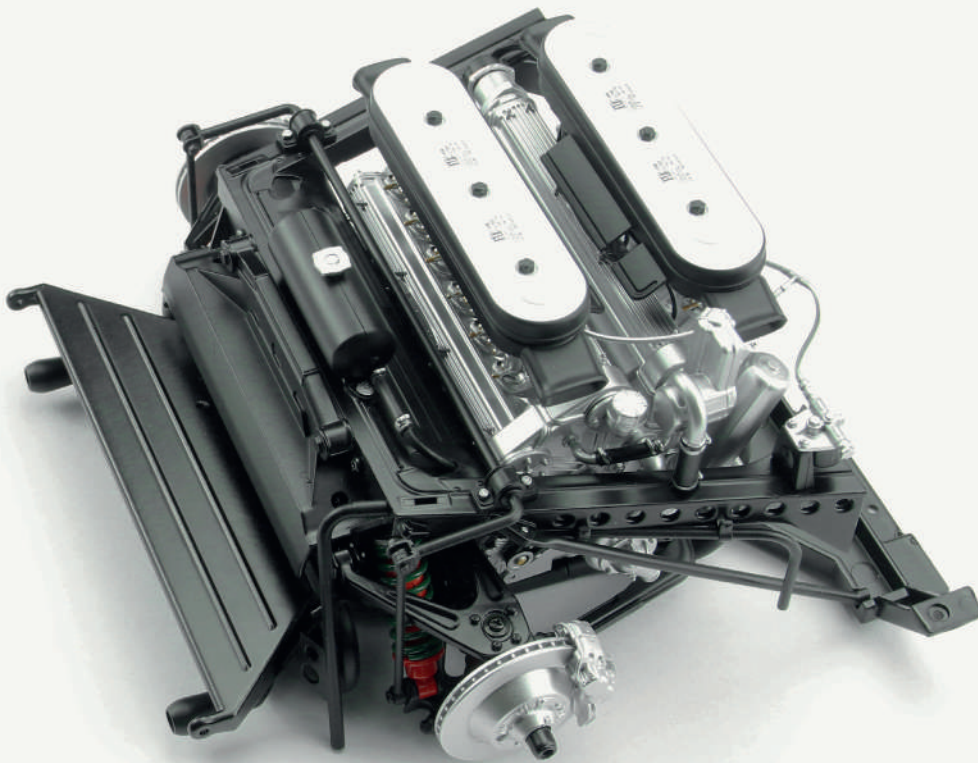

## Stage 37: Assembling a Rear Tyre

This stage involves fitting together the rim and tyre of one of the rear wheels. There's also an optional step for painting the screws for the horizontal pipe fitted in the previous stage.



### STAGE 37 PARTS LIST

| Name         |
|--------------|
| Pirelli tyre |
| Wheel rim    |



## Stage 37: Assembling a Rear Tyre

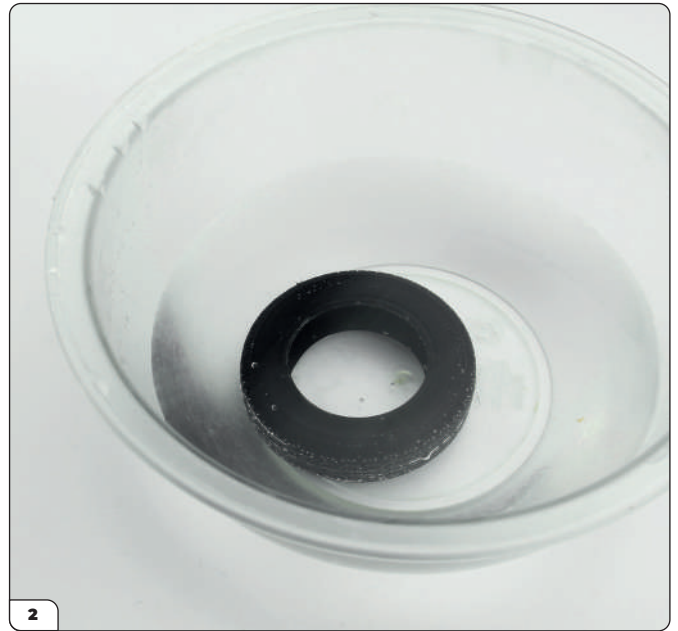

The wheel rim accurately replicates the Campagnolo rim from the Miura S. There are two sides: the inner and outer face, which are labelled in the photos above.

Place the tyre in a bowl of warm water for a few minutes to soften the rubber, which will help with fitting it onto the rim.



Remove the tyre from the water and quickly dry it with a paper towel.



Insert the rim into the tyre as shown.



## Stage 37: Assembling a Rear Tyre



Begin to flatten the rim as it is pushed in.



Squeeze the tyre so that the lip fits into the recess around the rim.



Once it is in place around the rim, both sides of the tyre should look like this.

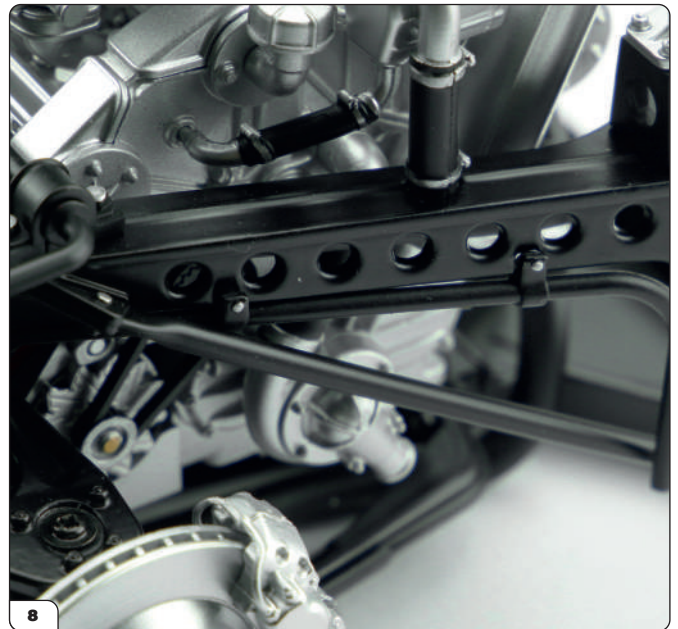

To add some more detail to your model, we recommend using some chrome silver model paint and carefully picking out the screws of the horizontal bar fitted in stage 35.

## Stage 37: Assembling a Rear Tyre

---

STAGE COMPLETE



## Stage 38: Preparing the Transmission Tunnel Rear Panel

For this stage you will assemble the rear panel of the transmission tunnel by fitting the air vents into it. The passenger mat and footrest will be used in a later stage and can be stored away for now.



### STAGE 38 PARTS LIST

| Name                           |
|--------------------------------|
| Passenger footrest             |
| Transmission tunnel rear panel |
| Passenger mat                  |
| Air vent x2                    |



## Stage 38: Preparing the Transmission Tunnel Rear Panel



1  
Take the two air vents and lay them on your work surface. Note the patterned area on the face of the vents (arrows). The back of the vents have D-shaped fittings, as shown in the bottom image.



2  
In the transmission tunnel rear panel there are two matching D-shaped holes for fitting the air vents.



3  
Press the first air vent into the hole of the panel. If necessary, remove some excess paint from the edge of the D-shaped hole.



4  
Press the second air vent in place. The D-shaped fittings will ensure that the patterned areas are oriented correctly.

## Stage 38: Preparing the Transmission Tunnel Rear Panel

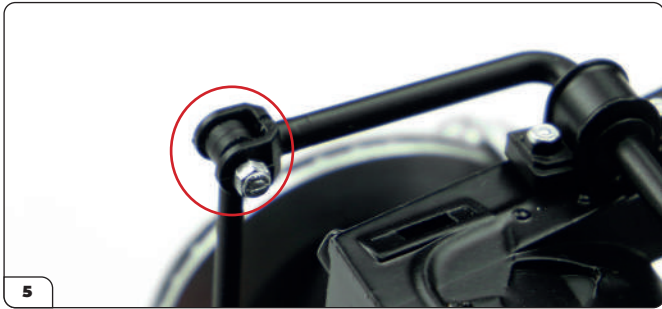
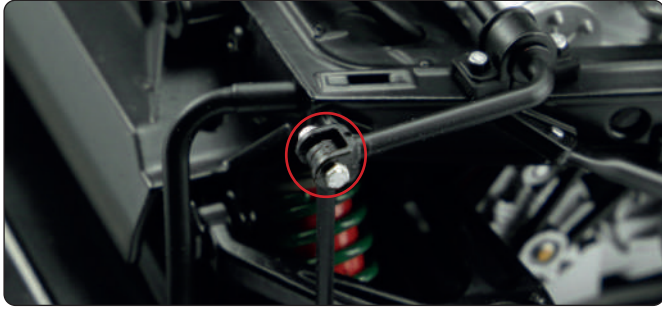

To add more detail to your model, you can pick out the screws on both sides of the anti-roll bar brackets using chrome silver paint.

**STAGE COMPLETE**



## Stage 39: Fitting the Passenger Footrest and Mat to the Cockpit Floor

This stage contains the cockpit floor for your Lamborghini Miura. You'll need the passenger mat and footrest supplied with the previous stage to fit them in the cockpit.



### STAGE 39 PARTS LIST

| Name          |
|---------------|
| Cockpit floor |



Cockpit floor

## Stage 39: Fitting the Passenger Footrest and Mat to the Cockpit Floor

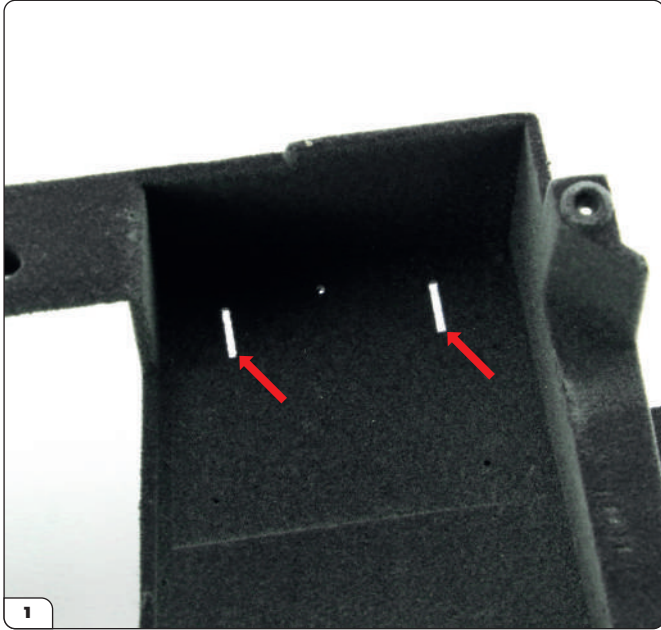

At the front of the cockpit floor there is a recess in the passenger footwell, along with two thin rectangular holes (arrows). Check for and remove any residue in these holes.

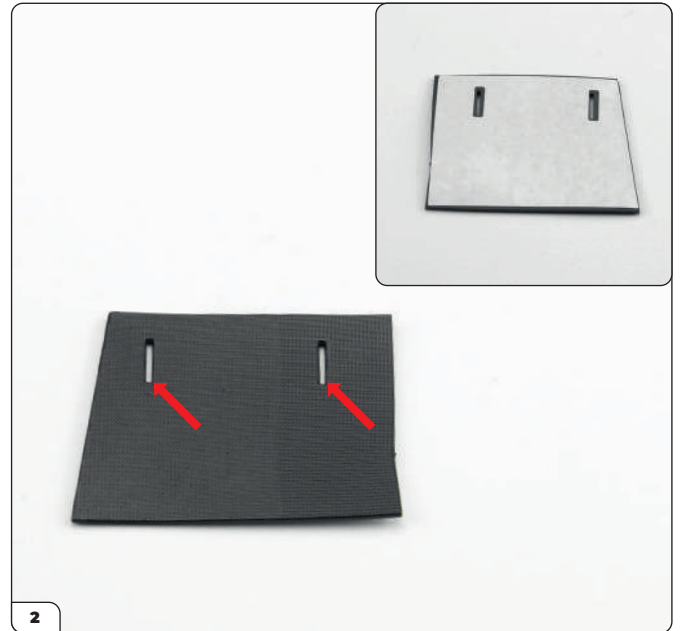

Take the passenger mat from stage 38. This has corresponding rectangular holes (arrows). There is backing paper on one side that covers the adhesive layer (inset).

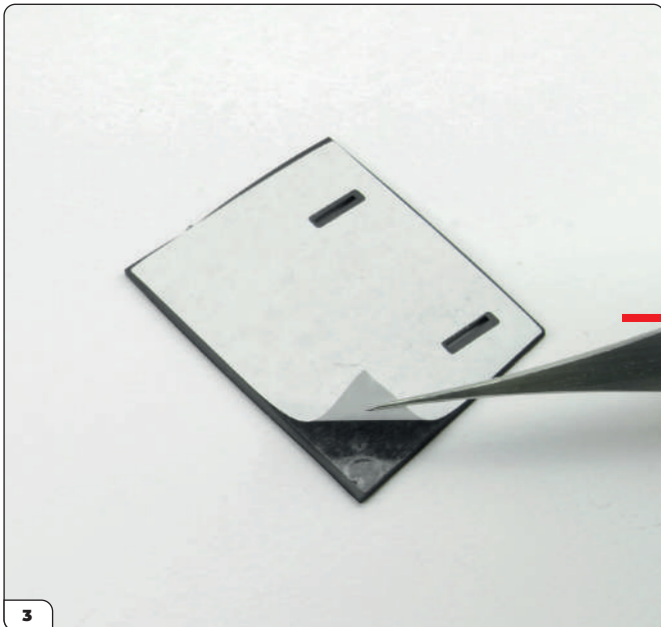

Peel the backing paper from the passenger mat to reveal the adhesive layer.

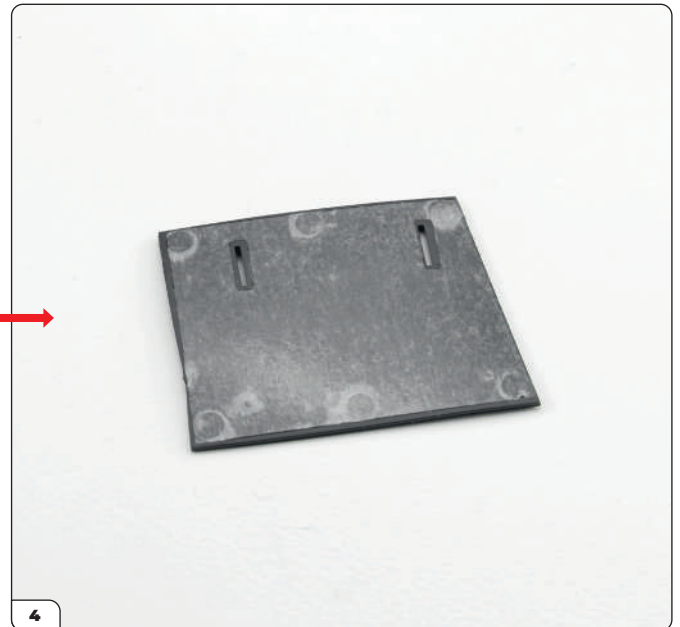

## Stage 39: Fitting the Passenger Footrest and Mat to the Cockpit Floor

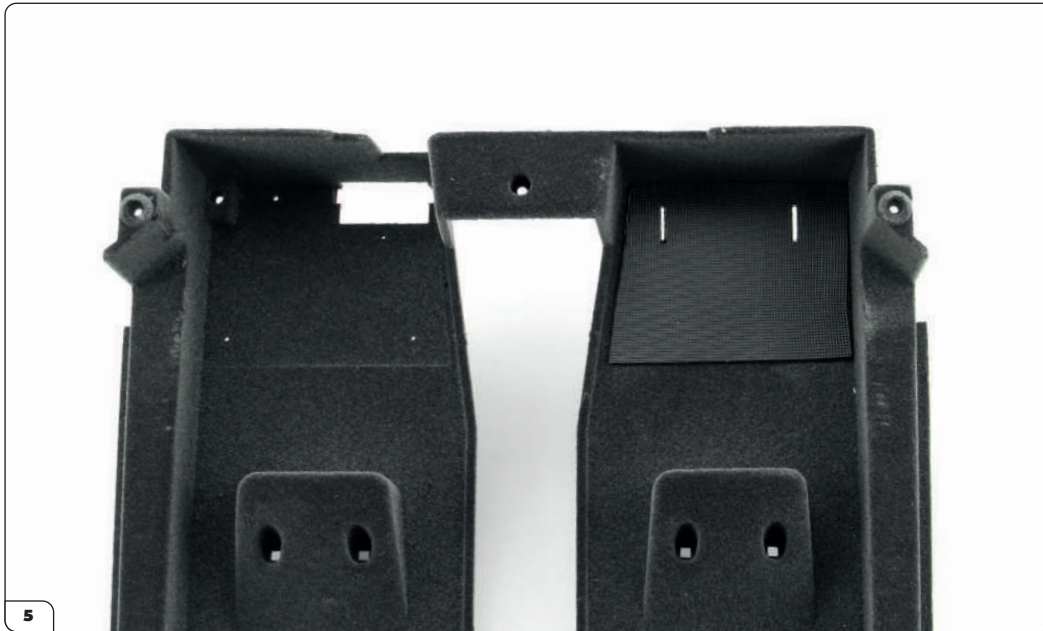

Use the adhesive to stick the mat into the recess in the passenger footwell, making sure that the rectangular holes align.



Now take the passenger footrest from stage 38. This has two tabs at the bottom which fit into the rectangular holes (arrows).

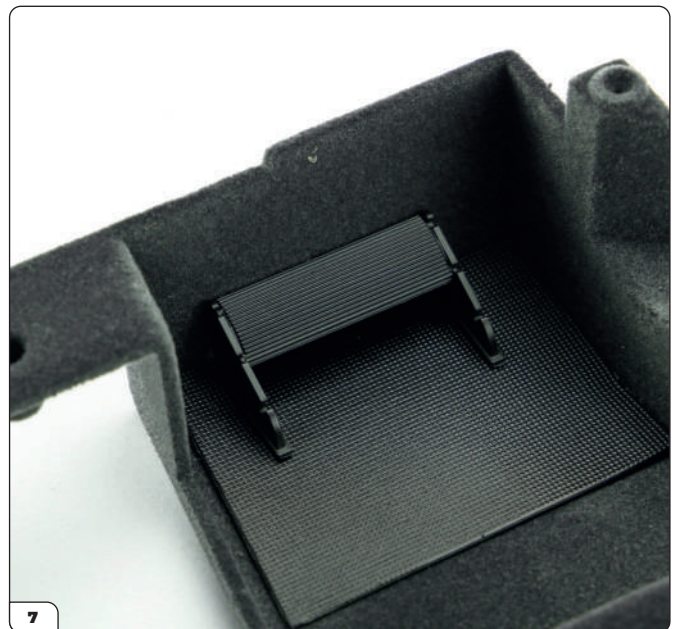

Orient the footrest as shown and firmly press its tabs into the rectangular holes until it is flush with the mat.



## Stage 39: Fitting the Passenger Footrest and Mat to the Cockpit Floor

STAGE COMPLETE

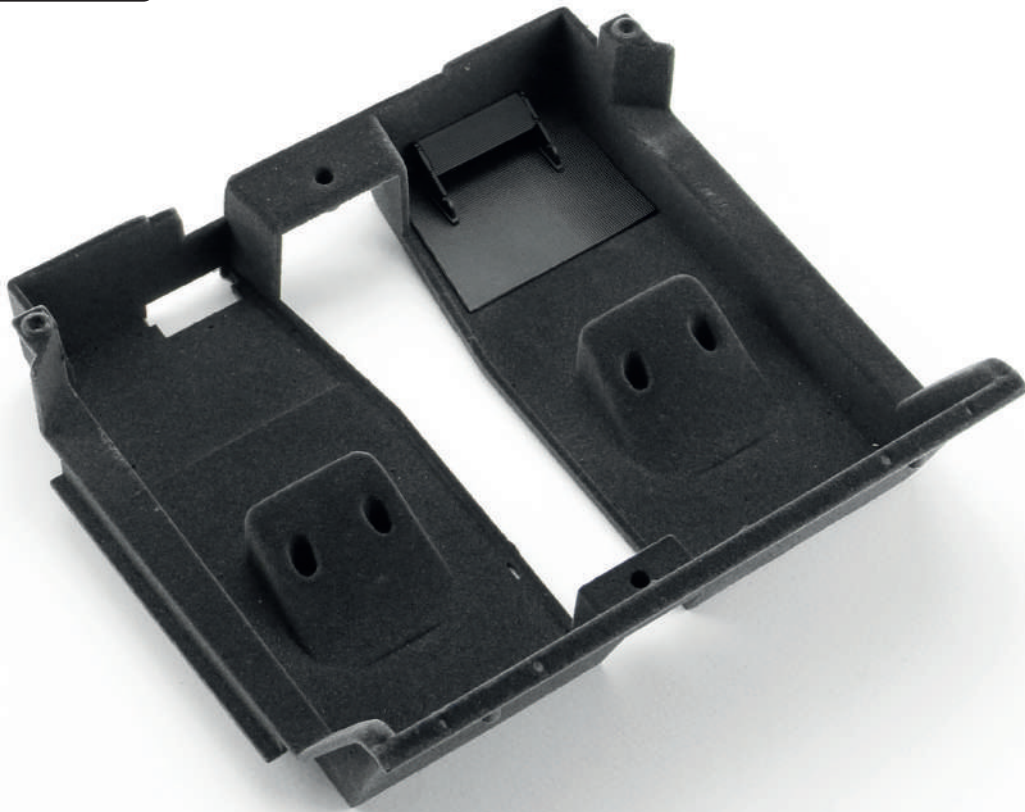

## Stage 40: Adding the Side Cover and Air Vents to the Transmission Tunnel

Next you'll prepare the transmission tunnel with some details: the air vents and a protective cover for the driver's side.



### STAGE 40 PARTS LIST

| Name                |
|---------------------|
| Transmission tunnel |
| Side cover          |
| Air vent x2         |



## Stage 40: Adding the Side Cover and Air Vents to the Transmission Tunnel



Take the air vents. On the back there are D-shaped fittings, as with the previous ones from stage 38.

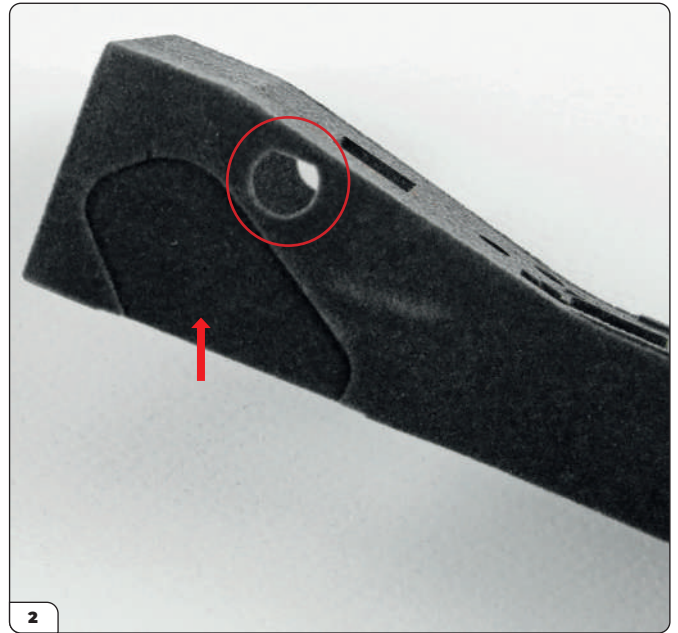

These fit into the corresponding holes in the transmission tunnel (circled). Note as well that the left hand side of the tunnel has a recess for the side cover (arrow).



Press one of the air vents into the shaped hole on the left hand side of the transmission tunnel.



Turn the tunnel around and locate the other shaped hole.

## Stage 40: Adding the Side Cover and Air Vents to the Transmission Tunnel

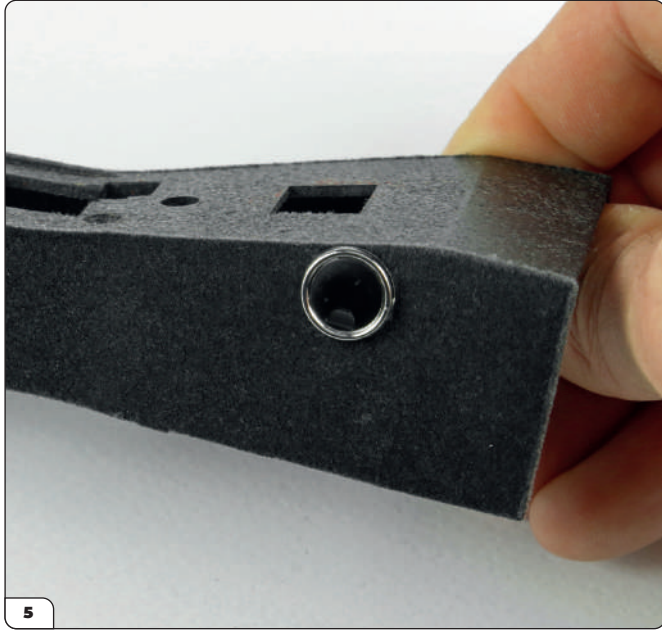

Press the remaining air vent in place. The shaped fittings ensure that the patterned sections of the vents are oriented correctly.



Next take the side cover. One side has backing paper that covers an adhesive layer (bottom image).



Peel away the backing paper from the side cover to reveal the adhesive layer (inset).

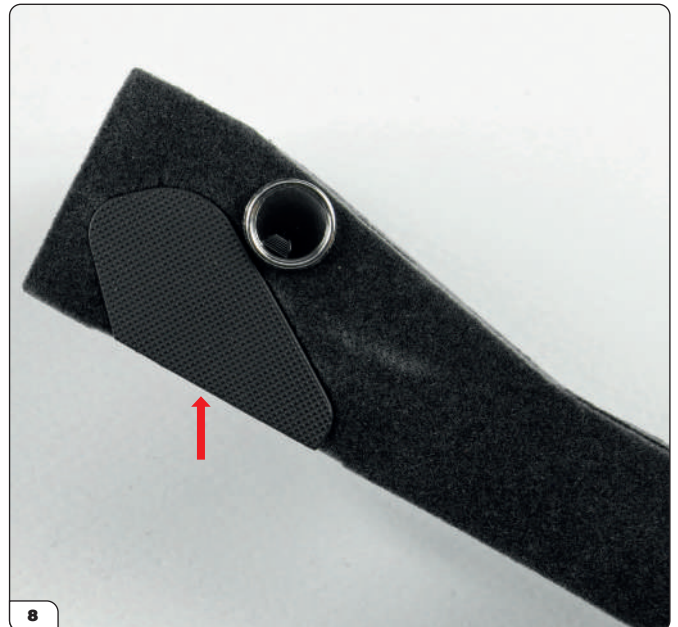

Align the cover with the recess in the left hand side of the transmission tunnel and firmly press it into position. Make sure the bottom edge of the cover (arrow) doesn't overlap the edge of the transmission tunnel.

## Stage 40: Adding the Side Cover and Air Vents to the Transmission Tunnel

---

STAGE COMPLETE



# Stage 41: Fitting the Headrests and the Driver's Side Details

Returning to the cockpit floor, this stage involves adding the rear bonnet lever to the driver's side along with the footwell mat. You'll also install the headrests for both the driver and passenger.



## STAGE 41 PARTS LIST

| Name                           |
|--------------------------------|
| Driver and passenger headrests |
| Driver mat                     |
| Rear bonnet lever              |
| Rear bonnet lever knob         |
| Type B screws x5               |



**Note:** the rear bonnet lever knob should be packaged in the same bag as the driver and passenger headrests. Take care not to lose it when unpacking the parts in this stage!

## Stage 41: Fitting the Headrests and the Driver's Side Details

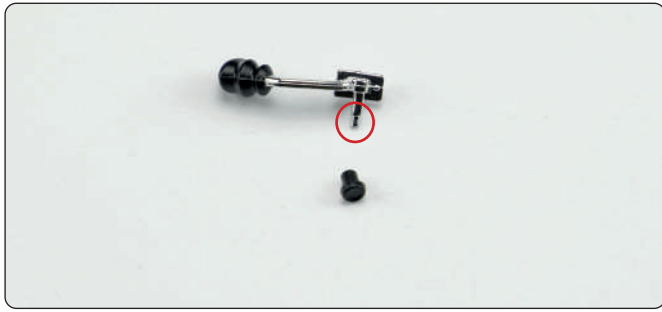

**1** Take the rear bonnet lever and its knob. There is a small pin (top image, circled) for fitting the knob in place. Press the parts together as shown in the bottom image.

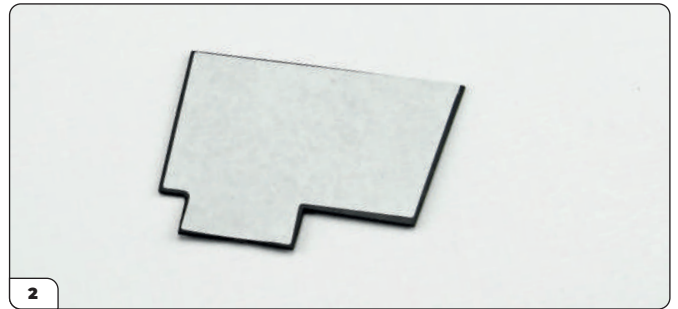
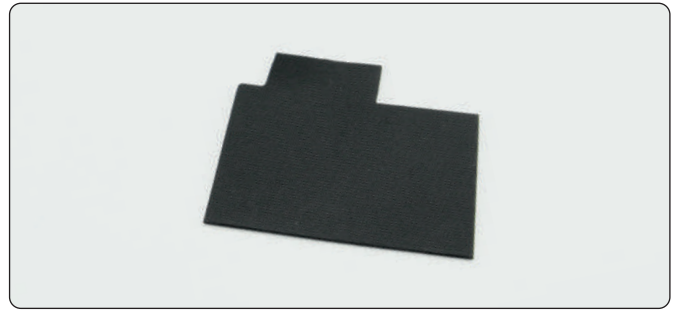

**2** Take the driver mat. One side has backing paper that covers an adhesive layer (bottom image).

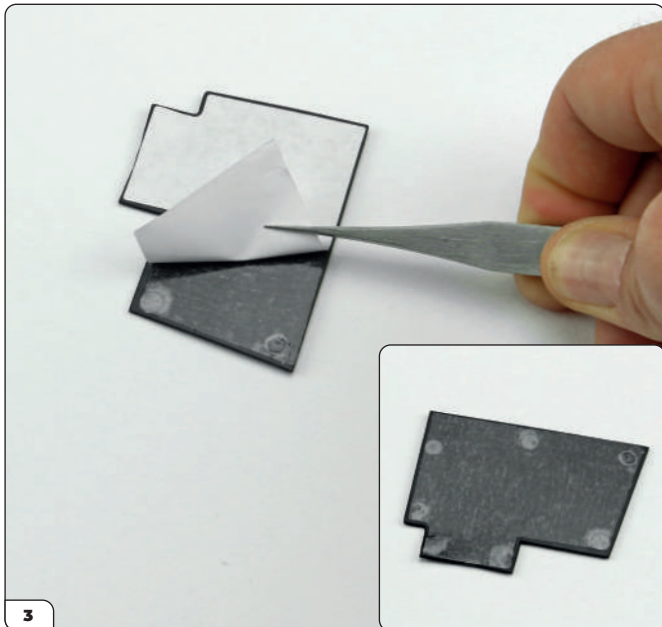

**3** Peel away the backing paper from the driver mat to reveal the adhesive layer (inset).



**4** Place the cockpit floor from stage 39 on your work surface. Align the driver mat with the recess located in the footwell on the left side of the cockpit and stick it in place using the adhesive layer.

# Stage 41: Fitting the Headrests and the Driver's Side Details



Locate the small rectangular hole on the driver's side of the cockpit floor (circled). Take the rear bonnet lever assembled in step 2 and firmly press it into the rectangular hole, orienting it so that the side knob is facing towards the inside of the cockpit (inset).

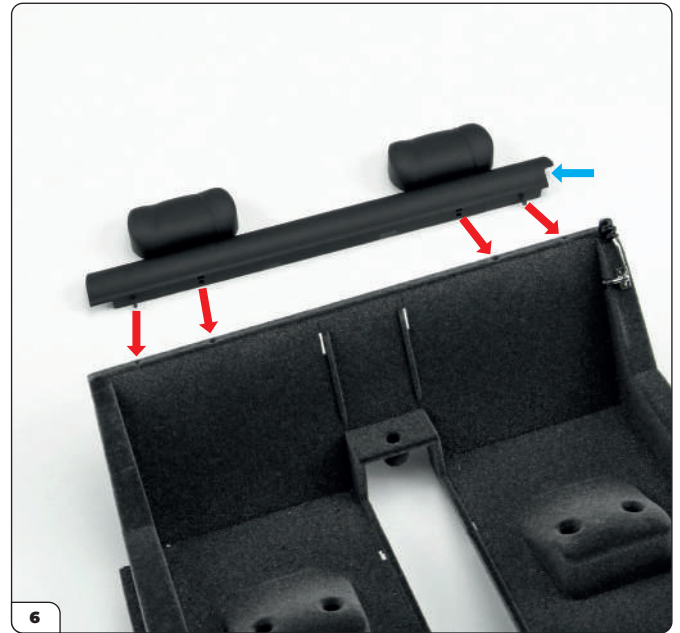

Align the driver and passenger headrests with the cockpit floor as shown, noting the indent for the rear bonnet lever (blue arrow). The headrest piece has two pins and two holes on the bottom edge. These correspond with four holes on the connecting edge of the cockpit floor (red arrows).

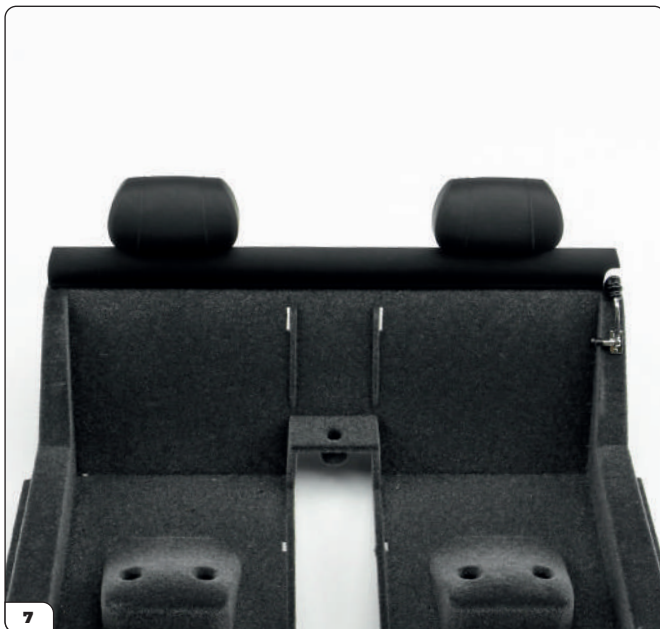

Press the two pins of the headrests into the outer holes of the cockpit floor. The inner holes should align once the pins are in place. These will be used for screwing the parts together in the next step.

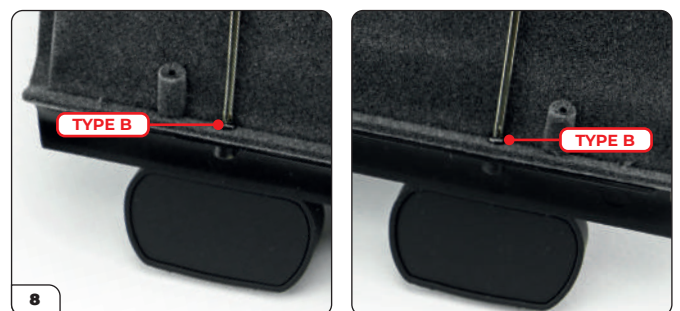
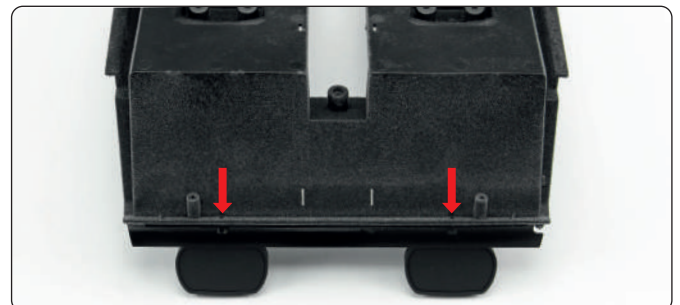

Turn the cockpit floor over and locate the two inner holes (top image, arrows). Drive a Type B screw into each hole as shown in the bottom images.



## Stage 41: Fitting the Headrests and the Driver's Side Details

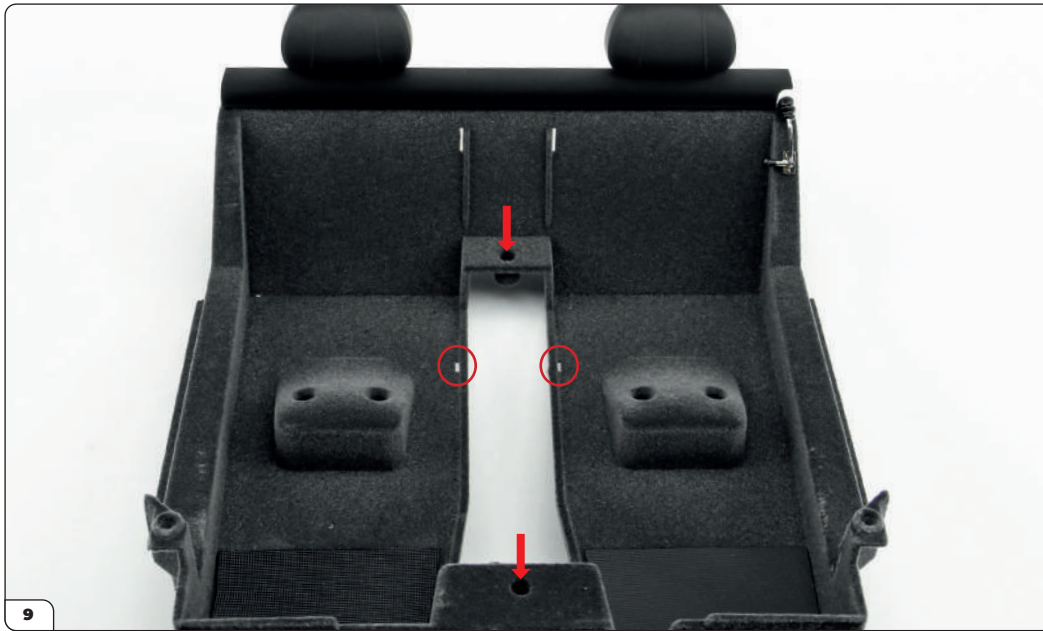

Turn the cockpit floor upright. For fitting the transmission tunnel, there are two large holes at the front and back of the floor (arrows) and two small rectangular holes in the middle (circled).



Take the transmission tunnel from stage 40 and press it into the holes highlighted in the previous step.

## Stage 41: Fitting the Headrests and the Driver's Side Details

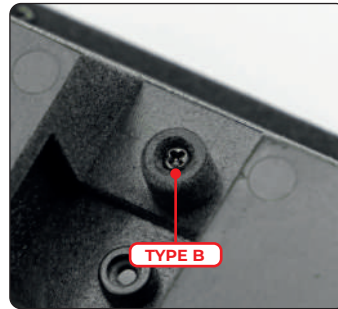
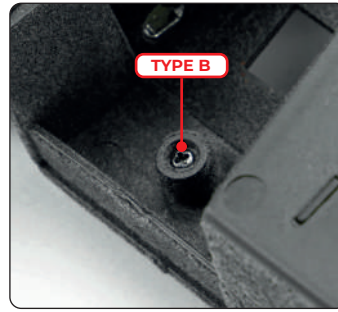

Turn the cockpit floor over and locate the screw posts at the front and rear (circled). As shown in the images on the right, use a Type B screw in each hole to secure the transmission tunnel to the cockpit floor.

STAGE COMPLETE



## Stage 42: Installing the Central Console and Rear Panel

In the last stage for this pack, the central console will have the engine sound switch installed before being fitted onto the transmission tunnel. You'll also fit the rear panel assembled in stage 38.



### STAGE 42 PARTS LIST

| Name                |
|---------------------|
| Engine sound switch |
| Key                 |
| Wiper knob          |
| Central console     |
| Type B screws x3    |

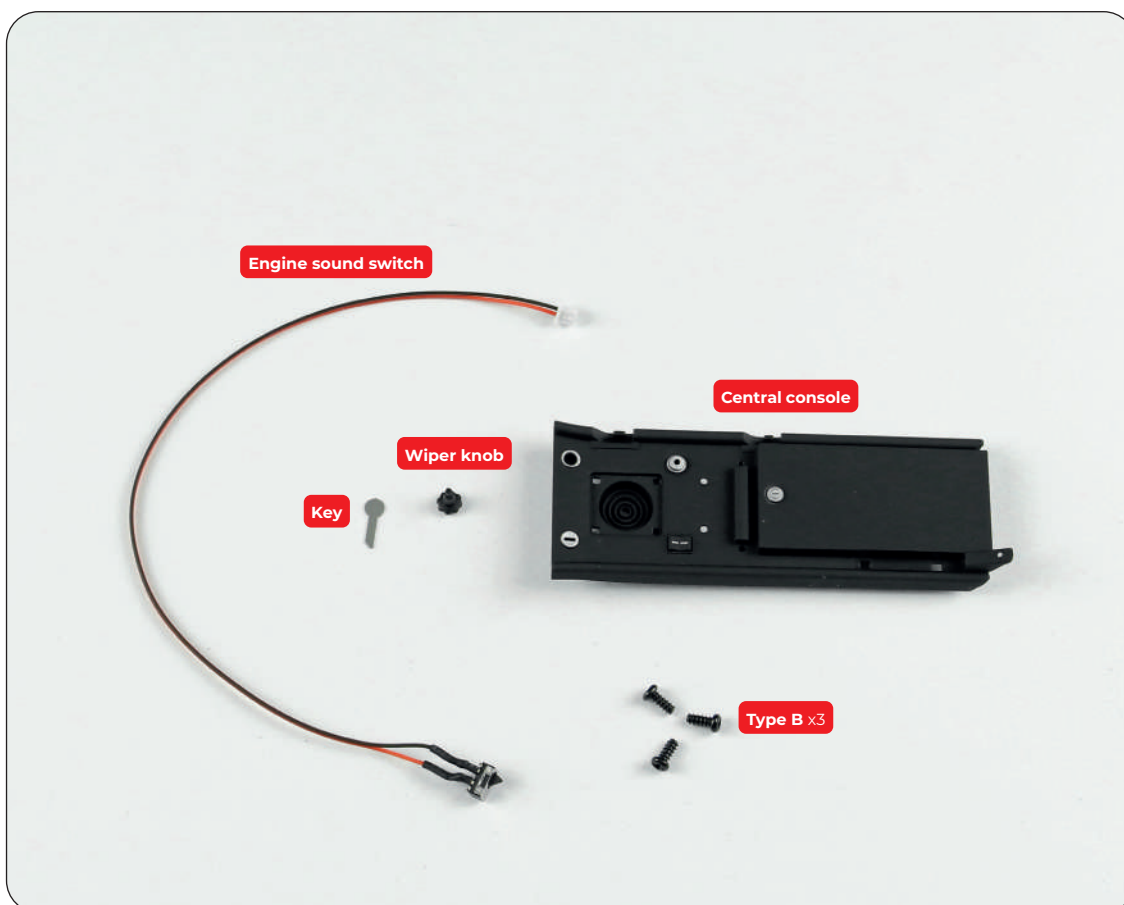

## Stage 42: Installing the Central Console and Rear Panel



First take the central console and the wiper knob. The knob fits into a small hole on the central console (circled). Press it in place as shown in the inset.

Note: there is text on the wiper knob. You can rotate the knob while it is in place so that the text is oriented correctly (inset).

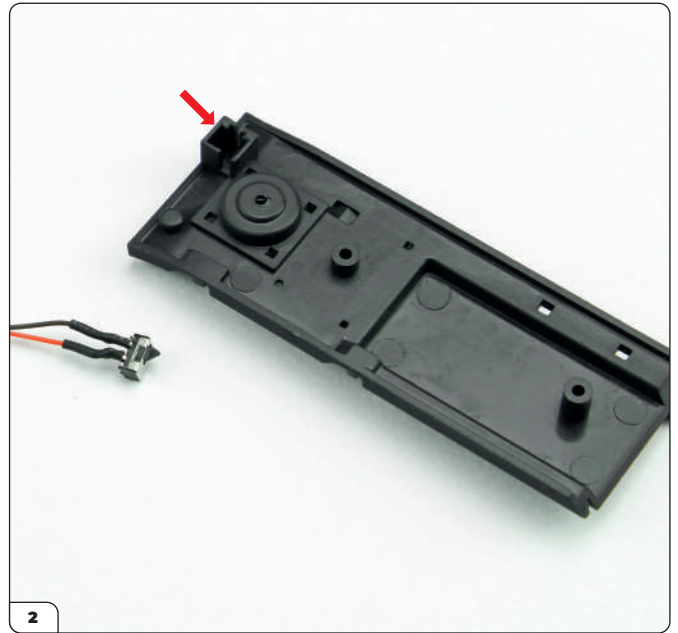

Turn the central console over and locate the housing for the engine sound switch (arrow).

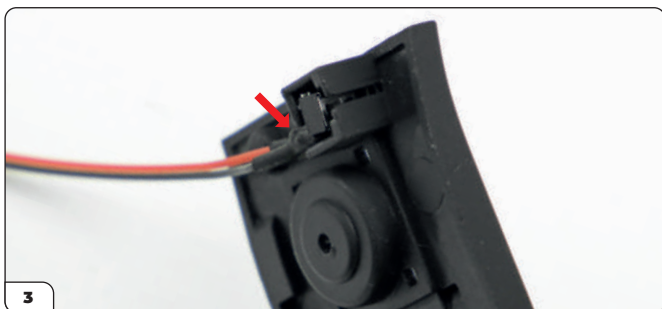
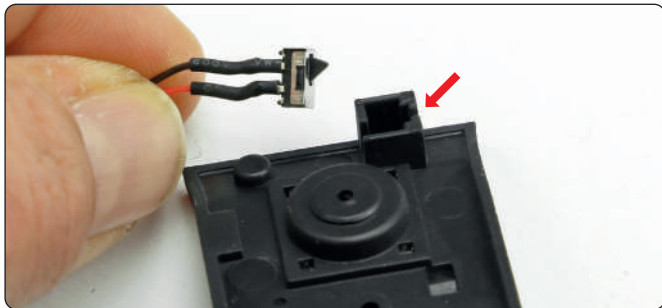

The switch for the engine sound is triangular. This fits into the thin slot facing outwards from the central console (top image, arrow). Fit the switch in place, pushing its wires into the space on the opposite side to the thin slot (bottom image, arrow).

Note: the switch provided in your pack has two small foam pieces stuck to its sides. Leave these attached, they will help keep the switch in place.



Now take the transmission tunnel rear panel assembly from stage 38 (inset) and the cockpit floor assembly. Locate the two rectangular holes at the rear of the cockpit, above the transmission tunnel (circled).

## Stage 42: Installing the Central Console and Rear Panel



Orient the rear panel as shown and press it into the rectangular holes indicated in the previous step.

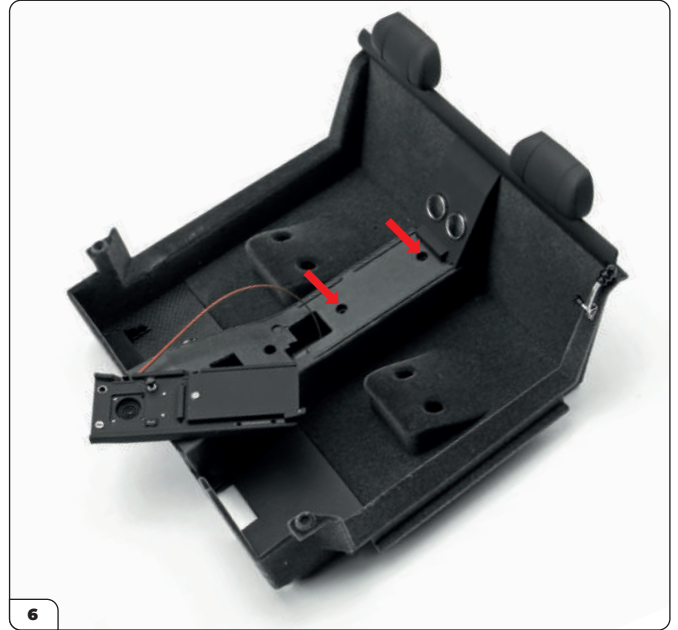

Next take the central console and thread the end of the engine sound switch's wire through the gap in the transmission tunnel. Note the two holes (arrows) which will be used for fitting the central console.



Push the central console in place. At the same time, bend the wire to allow it to protrude at an angle from underneath (see photo 8).

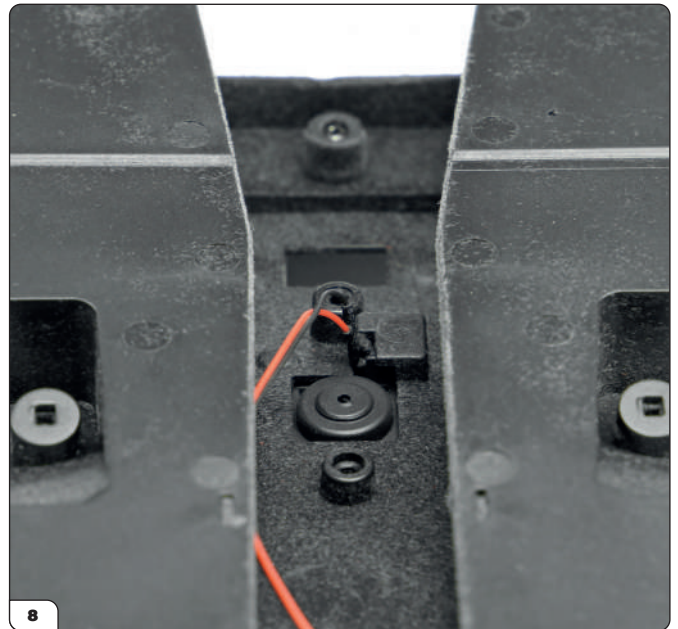

The wire from the engine sound switch should be fed through the transmission tunnel as shown once the central console is fitted.

## Stage 42: Installing the Central Console and Rear Panel

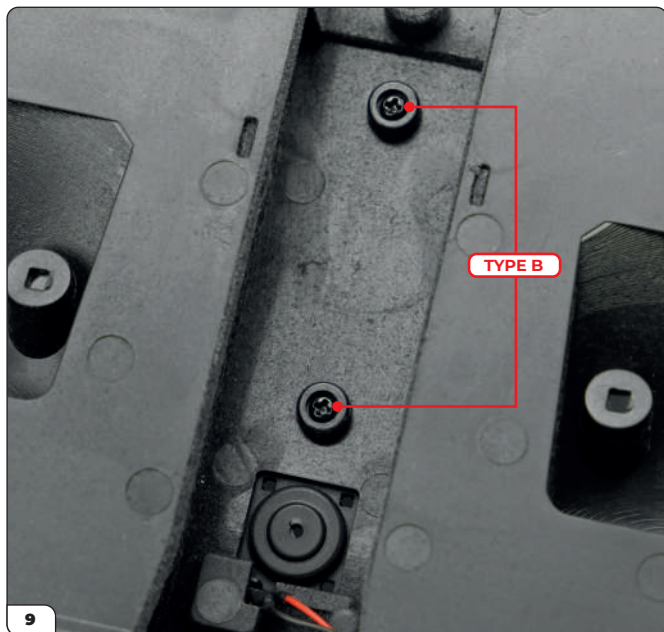

Locate the two screw holes and attach the central console to the transmission tunnel using 2x Type B screws.



The key fits in the slot of the central console as shown. You may wish to keep it in a safe place for now until the build is complete!

