



FDNY®

FIRE TRUCK TOWER LADDER 9



Pack 12

BUILD INSTRUCTIONS

**STAGE 70: ASSEMBLING THE LEFT
FLY SECTION**

**STAGE 71: ASSEMBLING THE RIGHT
FLY SECTION**

**STAGE 72: INSTALLING A STORAGE
COMPARTMENT, WALKWAYS AND TOOLS**

STAGE 73: REAR WHEELS

**STAGE 74: ATTACHING THE WHEELS &
COMPONENTS FOR THE ROOF**

**STAGE 75: AERIAL BASE SECTION LADDER &
WATERWAY**

**STAGE 76: AERIAL LOWER MIDSECTION
LADDER & WATERWAY**

**STAGE 77: AERIAL UPPER MIDSECTION
LADDER & WATERWAY**

**STAGE 78: AERIAL FLY SECTION LADDER &
WATERWAY, AND ADDING
THE FINAL DETAILS**

Advice from the experts

 **Please keep ALL unused screws as they will be required in a later stage.**

Please make sure you don't mix up the screws. They look quite similar, but the threads do vary slightly. Using the wrong screws may damage the parts.

When securing parts together using multiple screws, fit each screw loosely to ensure all the parts are correctly aligned before gently tightening them firmly, but not overtight, in the order in which you placed them.

The screwdriver can be magnetized by stroking it with a magnet (fridge magnet, etc.) enabling it to hold the screws and make assembly easier.

If a screw is tight going into a metal part, do not force it as you may shear the head off. Remove it and put a tiny smear of Vaseline, soap or light oil on the thread. That will lubricate it and make it easier to drive home.

During the course of this build, you will receive many pieces that you will assemble immediately – following the instructions in the corresponding stage – and other pieces that you should store safely to one side, for use in future assembly stages.

Left and Right! When building your fire truck, the left or right hand side refers to each side as you are sitting in the cab.



WARNING: Some parts are assembled using magnets. These magnets can cause serious injury if they are swallowed. Keep away from children. If you suspect a magnet has been swallowed, seek medical help straight away.

Stage 70: Assembling the Left Fly Section

In this final pack, you will assemble the sections of the ladder that extend from the boom, the long lengths of waterway, and add all the final details, including the wheels.

You'll start with the first ladder section, known as the Fly Section.



STAGE 70 PARTS LIST

Name
Fly section (left)
Waterway bracket
Stop plate
Type F screws x2
Set of spare screws



Stage 70: Assembling the Left Fly Section

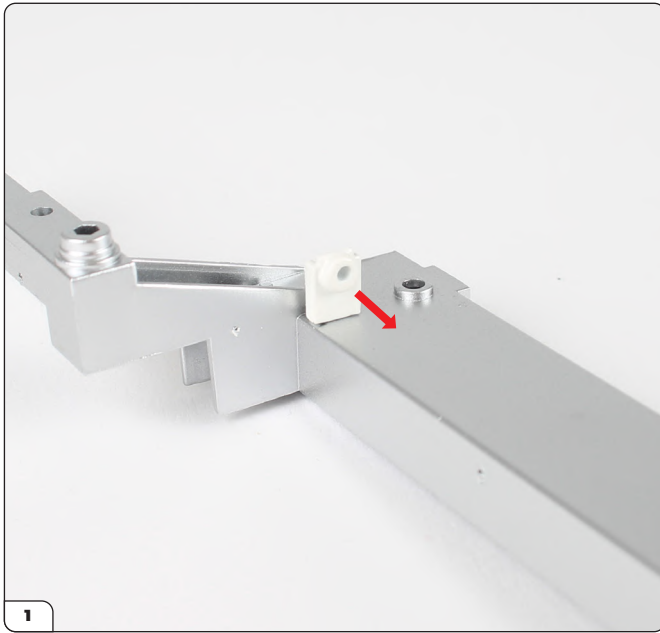

ATTACHING THE STOP PLATE

Take the fly section (left) and locate the fixing point for the stop plate. Ensure the raised side of the stop plate faces the longest length of the fly section, indicated by the arrow above. Push the stop plate firmly into place.

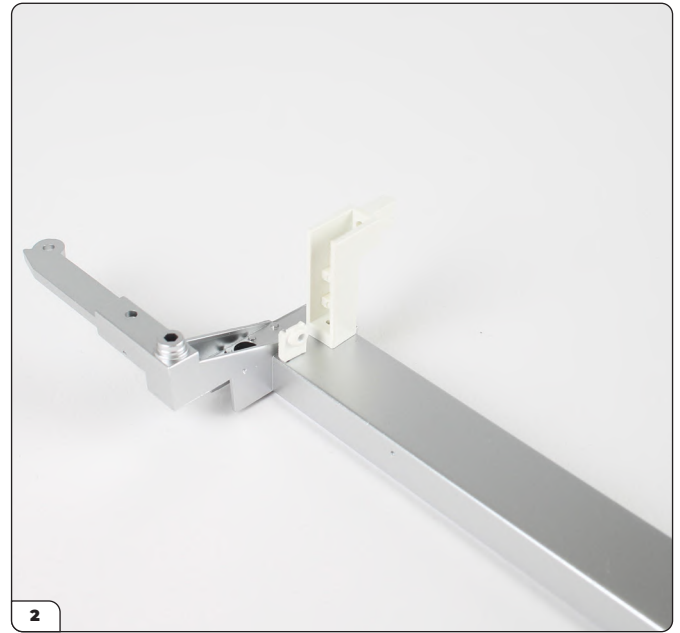

Position the waterway bracket over the raised screwhole, next to the stop plate, in the orientation shown.

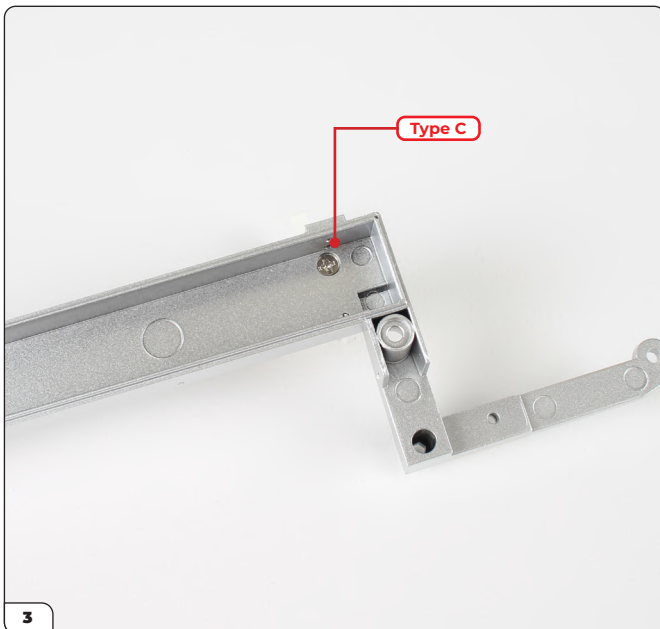

Fix the waterway bracket in place from the underside using a type C screw (supplied with pack 9).

Stage 70: Assembling the Left Fly Section



Stage 71: Assembling the Right Fly Section

In this next stage, you'll continue working on the Fly Section.



STAGE 71 PARTS LIST

Name
Fly section (right)
Stop plate
Screws type F x2
Screws type C x1
Screws type I x2



Stage 71: Assembling the Right Fly Section

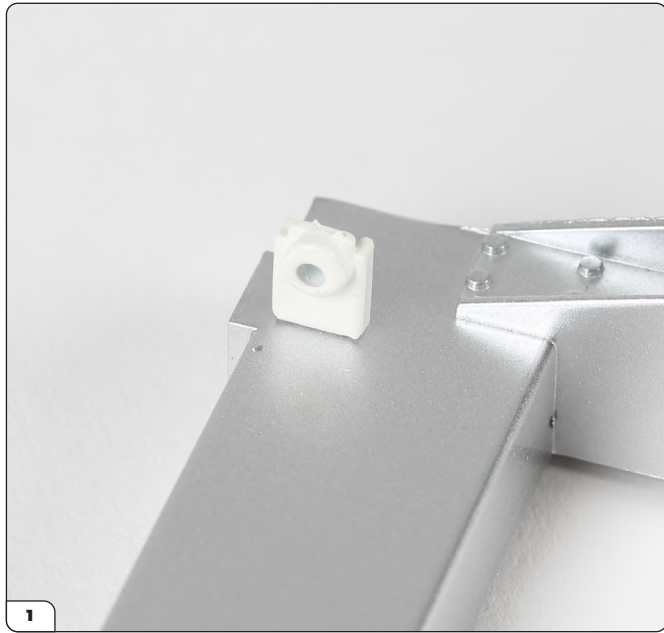

Push the stop plate into place on the fly section (right) as shown. As before, the raised side faces the longest length.

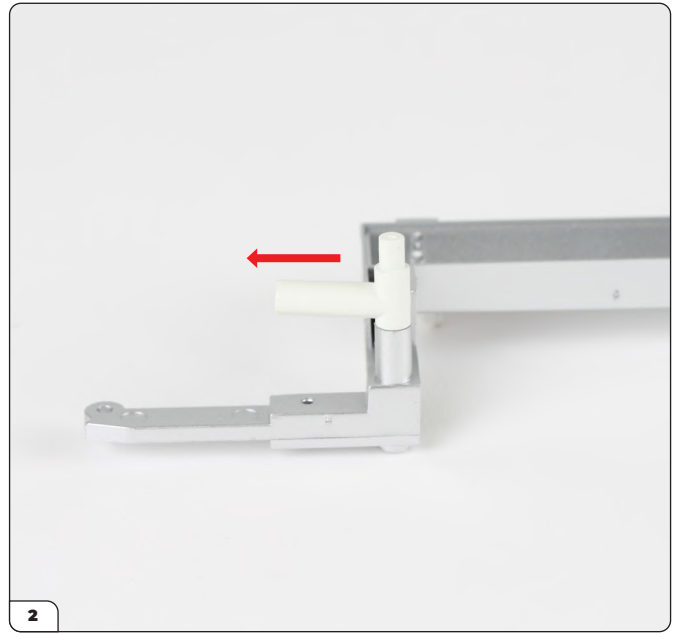

Turn the fly section over. Take the waterway connector from stage 62 and insert either side into the post on the fly section so that the widest tube of the connector faces away from the fly section (arrow).



Align both fly sections as shown.

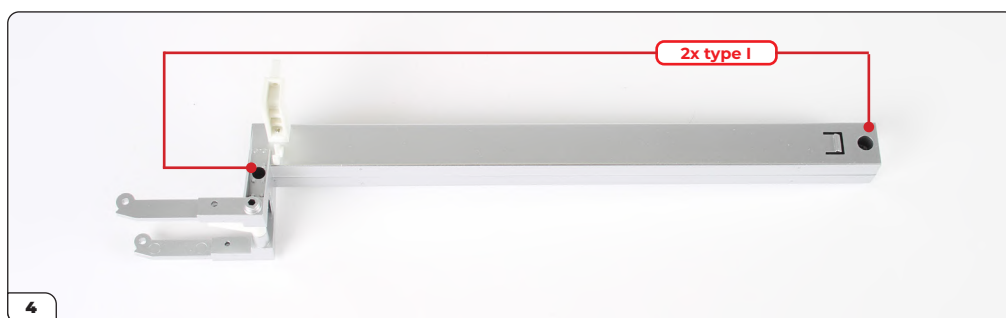

Join the fly sections together and secure them using 2x type I screws.

Stage 71: Assembling the Right Fly Section



Take the pistons from the platform assembly completed in stage 52.

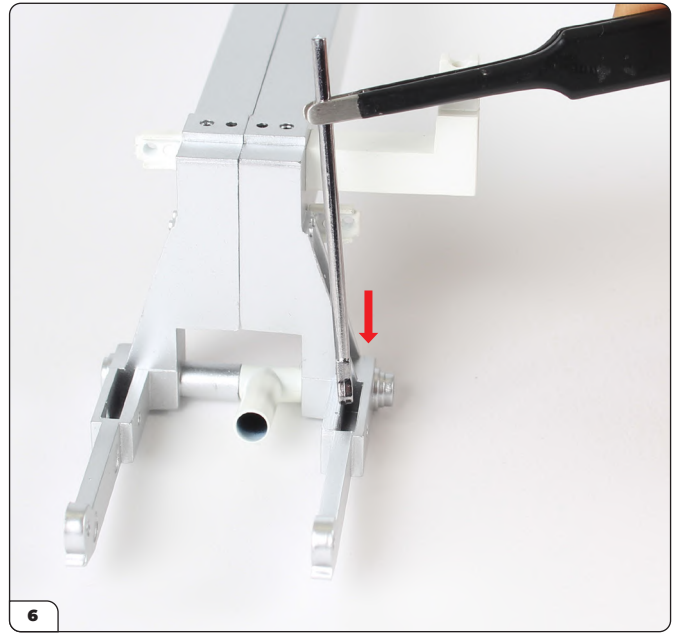

Align the screwhole on the flat end of one of the pistons with the screwhole inside the projecting arm of the fly section.

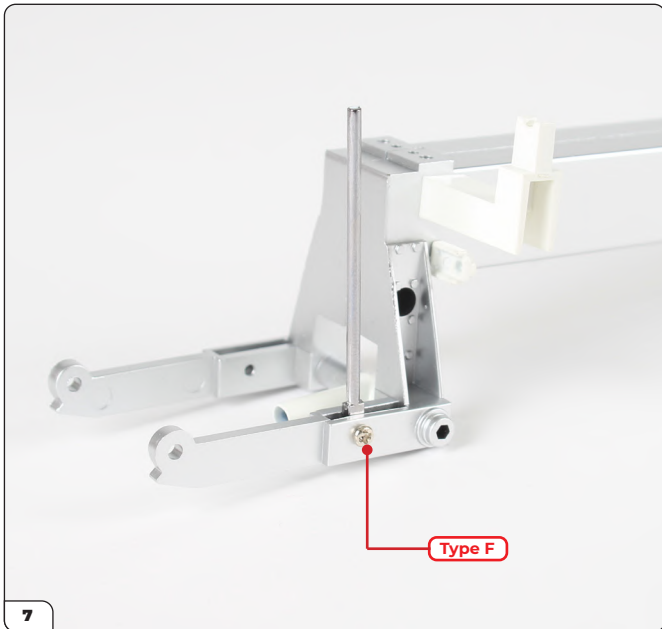

Secure the piston in place using a type F screw



Repeat steps 6 & 7 to attach the second piston.

Stage 71: Assembling the Right Fly Section

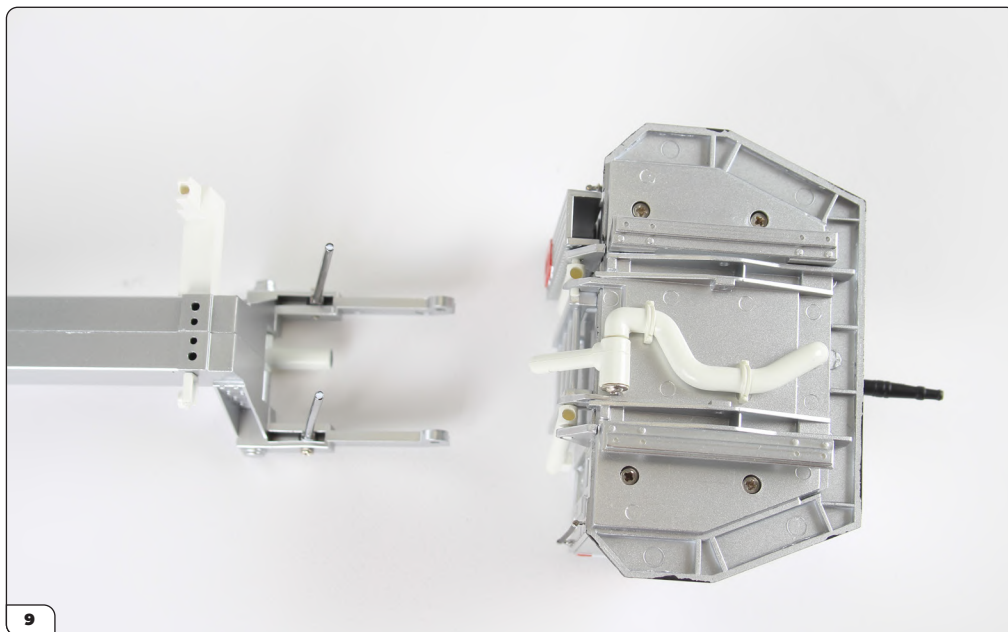

Align the pistons on the end of the fly section with the platform in the upturned position.

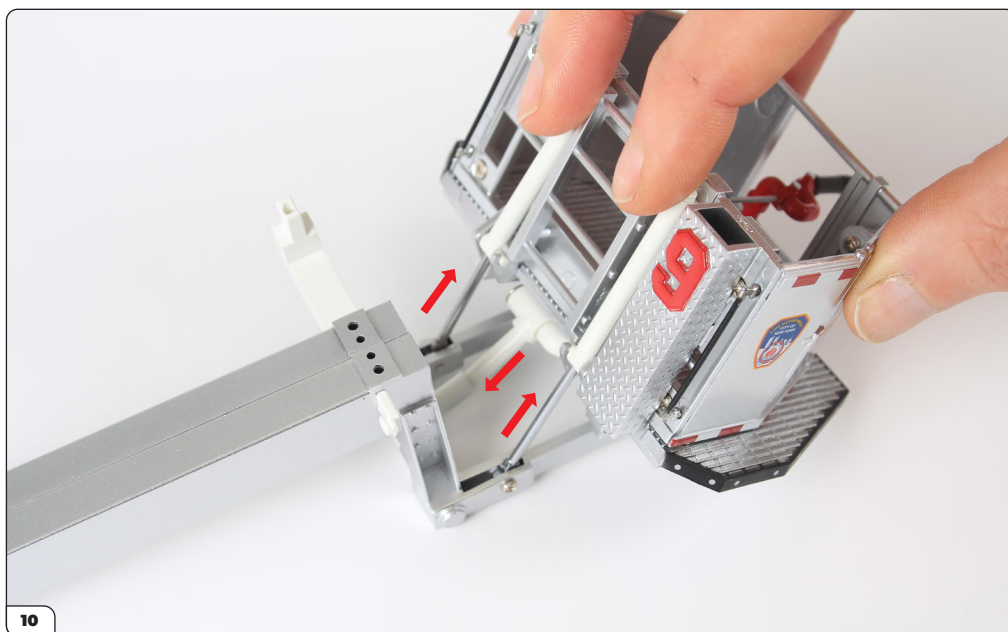

Insert the piston poles into the piston outer sections, and at the same time, insert the 'T' shaped pipe into the waterway connector attached in step 2.

Stage 71: Assembling the Right Fly Section

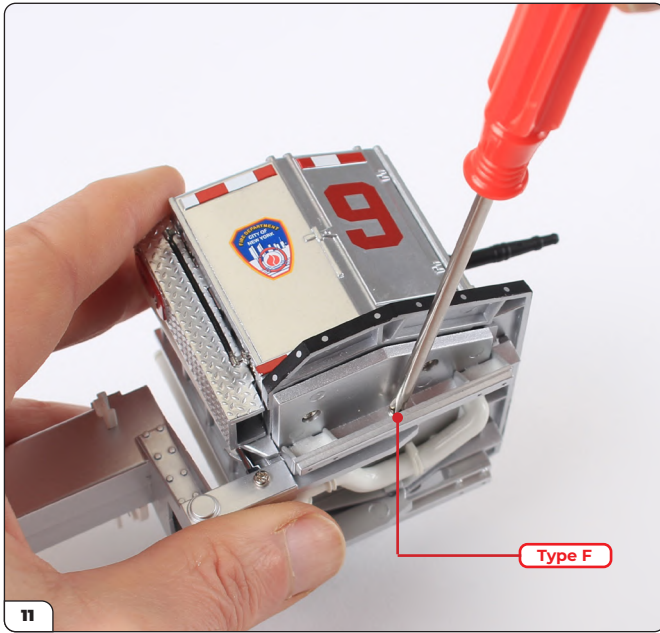

Fix the platform to the fly section using a type F screw.

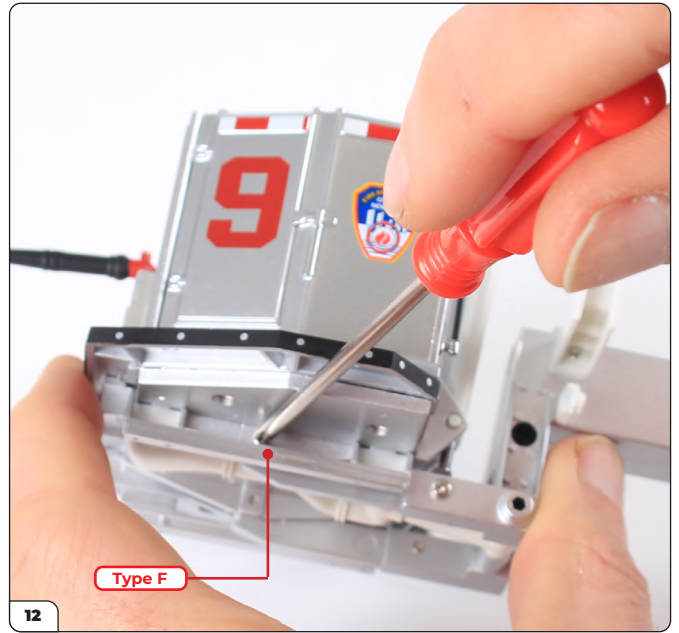

Fix the other side of the platform using another type F screw.

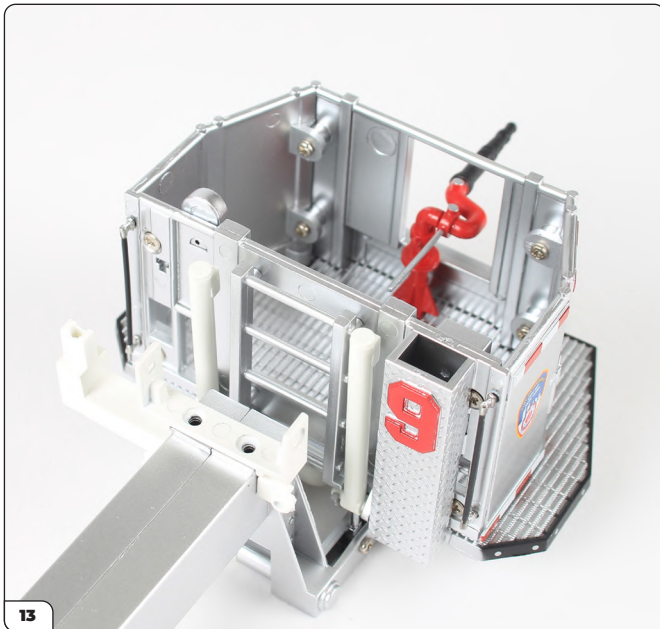

Take the ladder bracket from stage 63 and position it over the pair of screw holes on the end of the fly section.

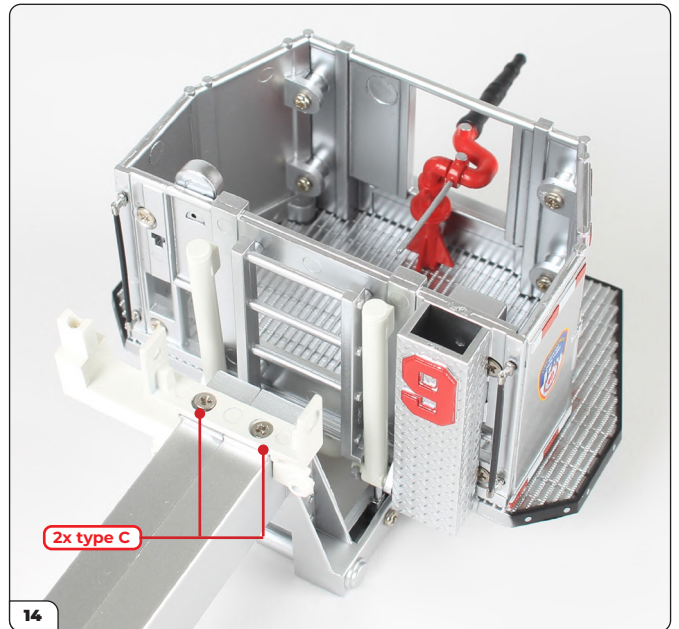

Fix the ladder bracket in place using 2x type C screws.

Stage 71: Assembling the Right Fly Section



Gently but firmly push the free end of the fly section into the open end of the boom mid-section.



Keep gently pushing until the fly section snaps into place.

Stage 71: Assembling the Right Fly Section

STAGE COMPLETE



Stage 72: Installing a Storage Compartment, Walkways and Tools

In stage 72, you'll attach the final storage compartment and add details to the roof.



STAGE 72 PARTS LIST

Name
Storage compartment
Large raised walkway
Small raised walkway
Medium raised walkway
Small front wheel hubcap
Large rear wheel hubcap
Compartment handle
Hydraulic ram jack
Axe
Type L screw x1



Stage 72: Installing a Storage Compartment, Walkways and Tools

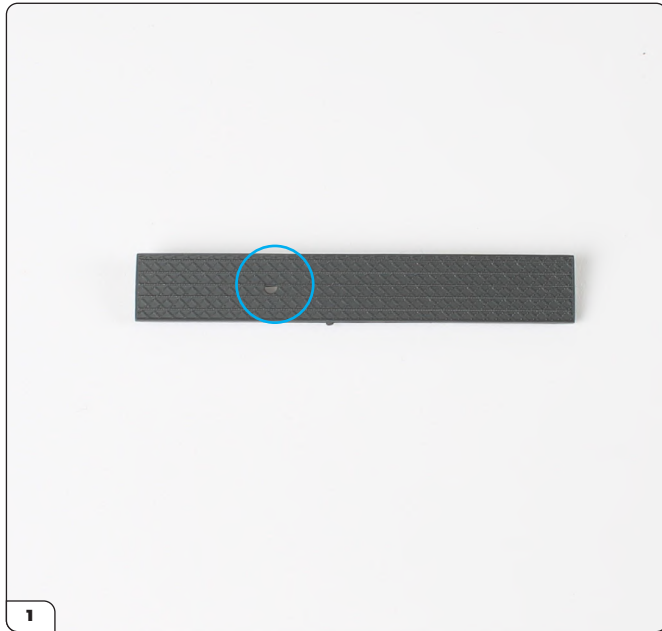

Take the large raised walkway and note there is a hole at one end, shown here to the left (circled).



With the hole to the rear of the truck, press the walkway into place on the right-hand side of the main body, just underneath the 'TOWER LADDER 9' sign.



With the three holes on the storage compartment facing up, align the D-shaped fixing points for the handle and the compartment.

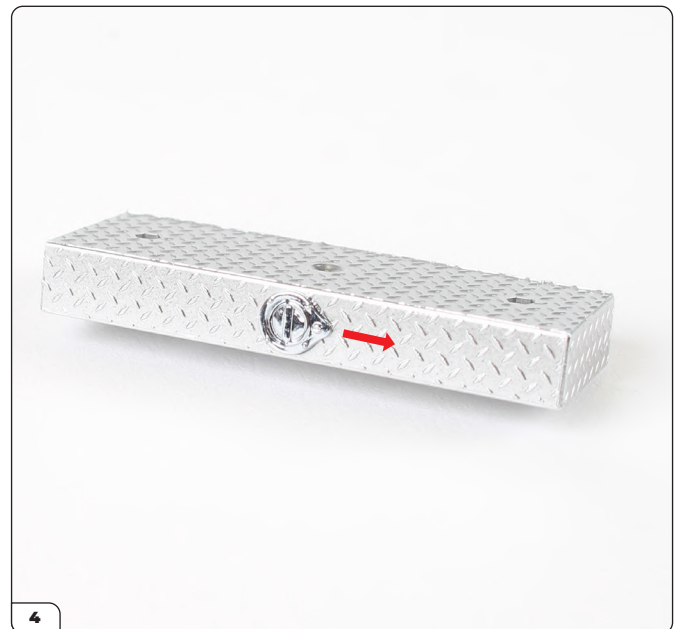

Press the handle firmly into place. The 'point' faces to the right (arrow).

Stage 72: Installing a Storage Compartment, Walkways and Tools



Align the fixing points on the medium walkway with the holes in the roof of the storage compartment.



Push firmly into place.



Press the storage compartment assembly into position on the roof, above the storage compartment marked 'FIRE' at the rear of the main body.

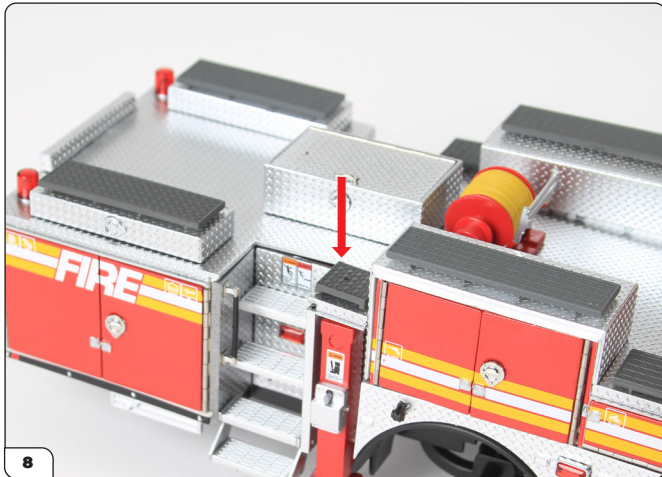

Push the small walkway into the roof, above the jack.



The axe is stored in the compartment above the rear wheels, on the right-hand side. Push its lugs into the holes in the bottom of the compartment.

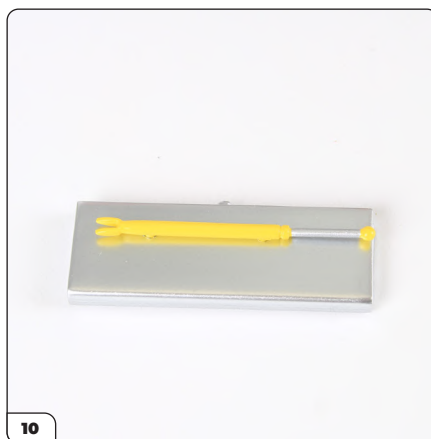

To fix the ram jack, first slide out the shelf above the sledge hammer. Push the ram jack lugs into the two holes on the shelf.



Slide the shelf back into the compartment.

Stage 72: Installing a Storage Compartment, Walkways and Tools

STAGE COMPLETE



Stage 73: Rear wheels

Now it's time to complete the wheels...



STAGE 73 PARTS LIST

Name
Rear tires x4
Outer wheel x2
Inner wheel x2
Screw type L x1



Stage 73: Rear wheels



ASSEMBLING THE WHEEL

Push the inner wheel into one of the rear tires so that the tire rim tucks snugly around the groove on the wheel. If the tire is very tight, try soaking it in a hot water bath for one minute.



Push the outer wheel into the remaining tire and tuck the tire rim into the groove around the wheel.

Stage 73: Rear wheels

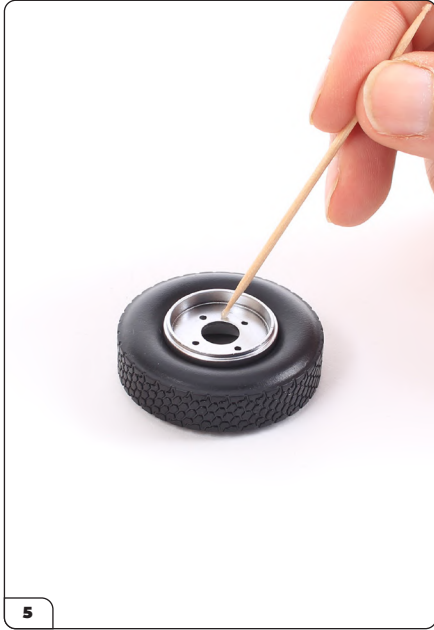

Apply a drop of glue to the flat surface of the inner wheel as shown.



Take the outer wheel and align the four fixing pins with the holes on the inner wheel before pushing the two wheels together. Press firmly.



The inner and outer wheels have been glued together.

Repeat steps 1-4 to make 2 of these rear wheels.

STAGE COMPLETE



The type L screw provided in this stage will be needed to attach the wheel in the next stage.

Stage 74: Attaching the Wheels & Components for the Roof

You'll continue the build by attaching more components for the roof.



STAGE 74 PARTS LIST

Name
Large accessory storage
Water cooler storage
Traffic cone
Accessory
Sand bottle
Hubcap
Water coolers
Screw type L x1



Stage 74: Attaching the Wheels & Components for the Roof



FITTING THE FINAL WHEELS

Take the wheel assemblies from the previous stage and prepare to fit them to the rear wheel hubs. Check that the outer wheel is facing you and slide one of the wheels into place on the right-hand rear-wheel hub.



Secure the wheels to the wheel hub using a type L screw from stage 73.



Fit the large rear wheel hubcap from stage 72 over the screw on the rear right wheel.



Fit the small front wheel hubcap from stage 72 over the screw on the front right wheel.

Stage 74: Attaching the Wheels & Components for the Roof



Now fit the remaining rear wheel to left-hand side. Check that the outer wheel is facing you and slide the wheels into place onto the wheel hub.



Secure the wheels to the wheel hub using a Type L screw supplied with this stage.

Finally, fit the hubcap supplied with this stage.



Push one of the water coolers into the smaller section of the accessory storage, applying a little super glue if necessary.



Press firmly to fix in place.

Stage 74: Attaching the Wheels & Components for the Roof



Take the large accessory and push it into the box as shown.



Press the assembled accessory storage box into the roof of the main body.



Lower the sand bottle into the tarp box and push firmly to fix.

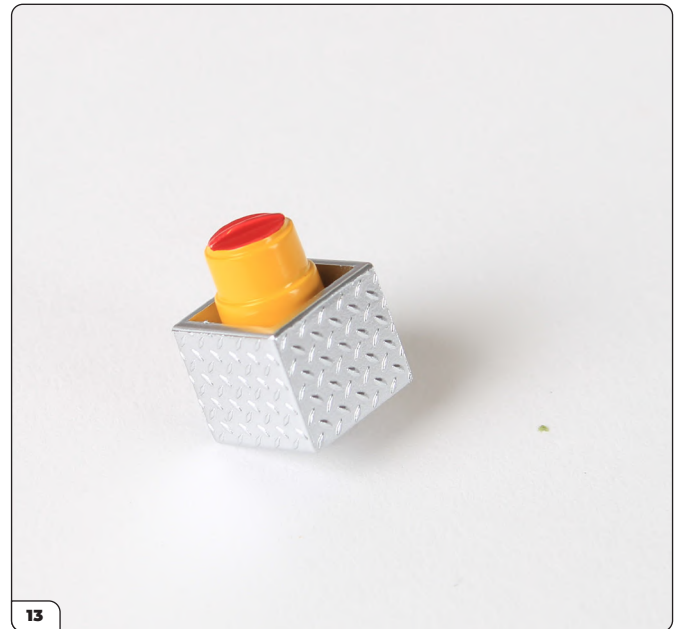

Take another water cooler and the water cooler storage. Push the water cooler into the storage box.

Stage 74: Attaching the Wheels & Components for the Roof



Press the water cooler storage into the hole in the large walkway.



Fit the traffic cone over the raised anchor point in the roof.

STAGE COMPLETE



Stage 75: Aerial Base Section Ladder and Waterway

You'll now attach the first in a series of ladders and waterway sections.



STAGE 75 PARTS LIST

Name
Base section ladder
Base section waterway

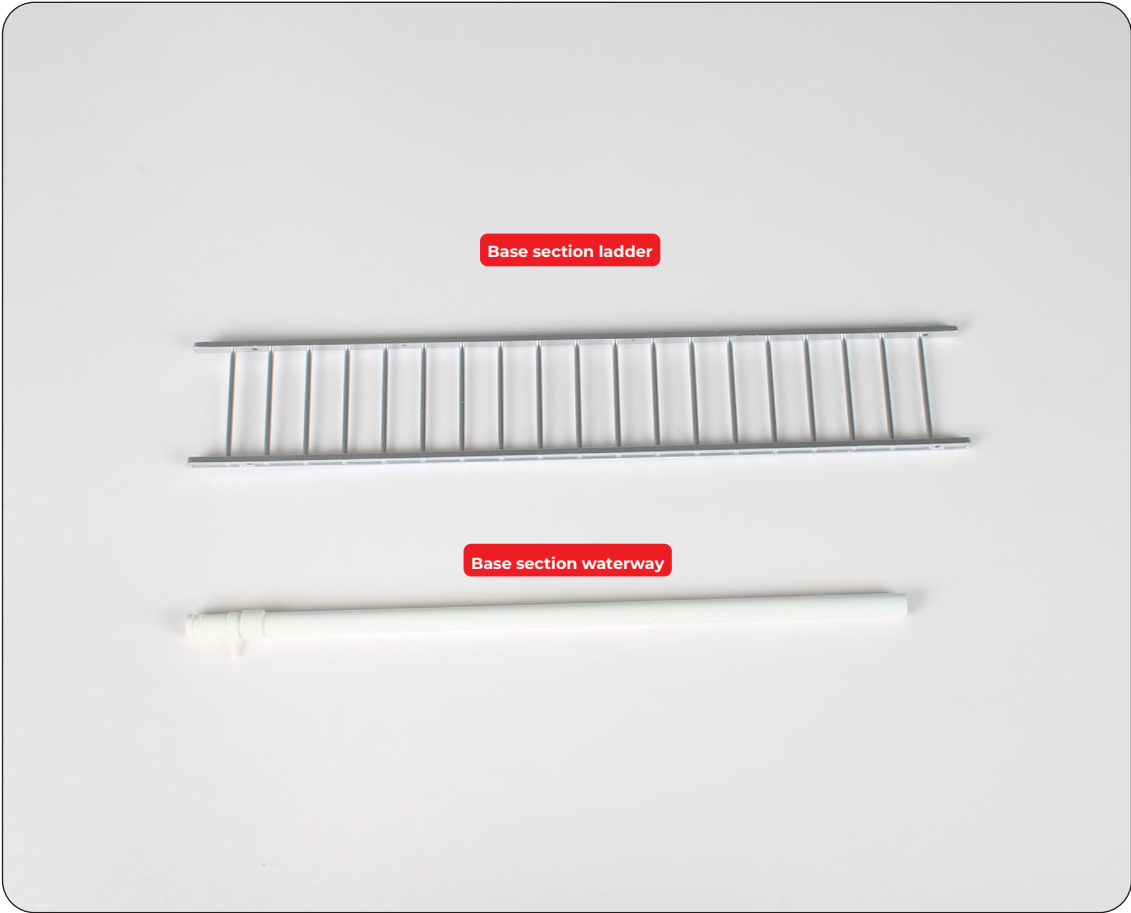

Stage 75: Aerial Base Section Ladder and Waterway



ATTACHING THE BASE LADDER SECTION

Take the ladder and note that there is a top and a bottom. The screw holes at the top are further from the end.



Feed the bottom end of the ladder into the ladder bracket at the bottom of the boom.



Align the screwholes on the ladder with those on the ladder bracket and secure the ladder on both sides using 2x Type B screws (supplied from the pack of spares).



Stage 75: Aerial Base Section Ladder and Waterway

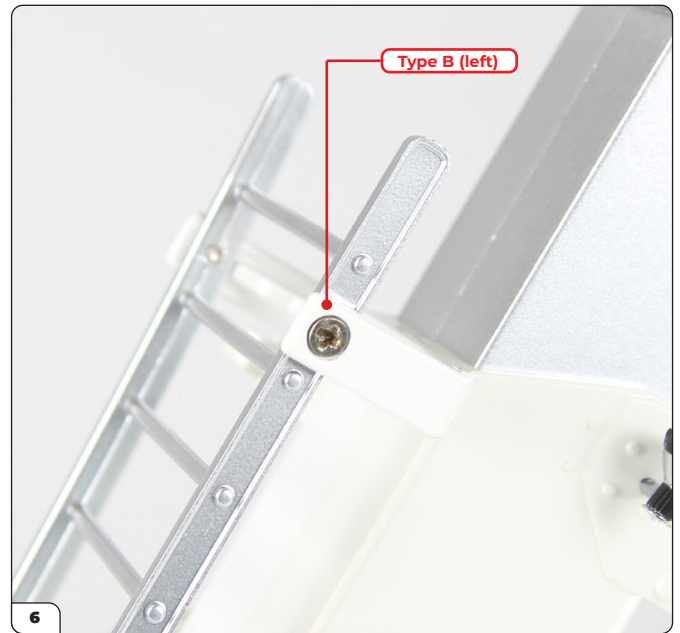
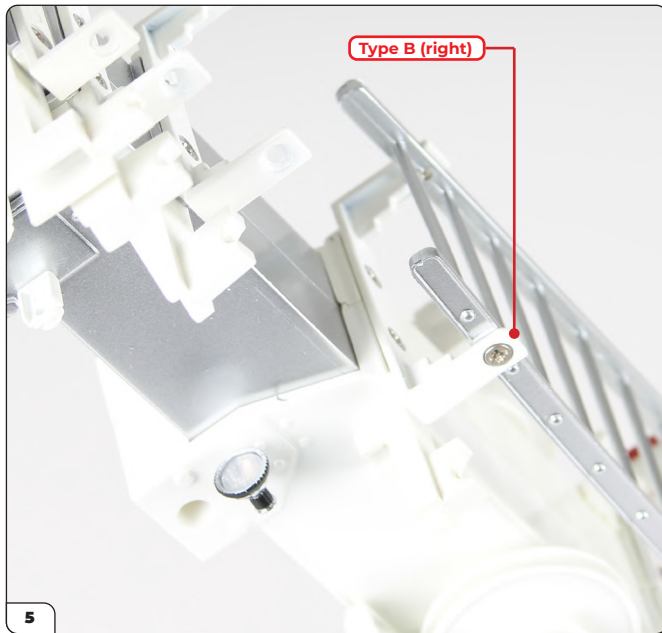

Position the top of the ladder in the ladder bracket at the top of the boom, aligning the screwholes. Secure the top of the ladder in place using 2x type B screws (supplied from the pack of spares).



Turn your attention to the waterway sections at the bottom of the boom. Check the three parts you have already assembled (in stage 62) are now in the orientation shown. Note the small pin (circled) on pipe b.

Anchor pipe b by pushing its pin into the small hole in the ladder bracket.

Stage 75: Aerial Base Section Ladder and Waterway



Take the base section waterway and feed the smooth end into pipe b.



Anchor the opposite end into the corresponding ladder bracket at the top of the ladder.

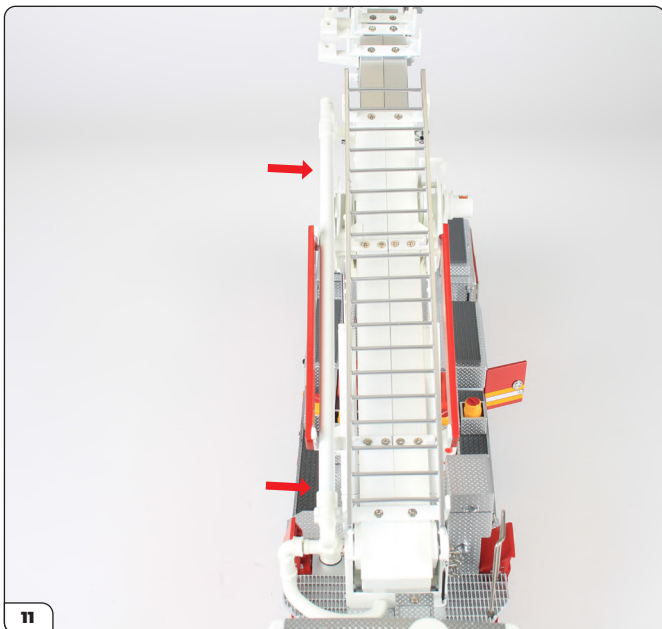

This shows the first base section waterway installed along the boom.

Stage 75: Aerial Base Section Ladder and Waterway

STAGE COMPLETE



Stage 76: Aerial Lower Midsection Ladder and Waterway

The lower midsection ladder and waterway will now be attached.



STAGE 76 PARTS LIST

Name
Lower midsection ladder
Waterway



Lower midsection ladder



Waterway

Stage 76: Aerial Lower Midsection Ladder and Waterway

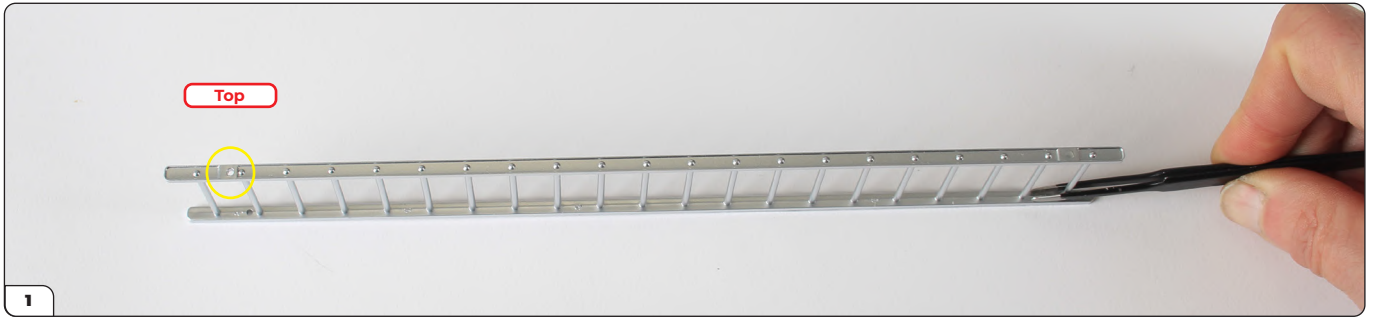

ATTACHING THE LOWER MIDSECTION LADDER

Take the ladder and note that the pair of screw holes are at the top end.

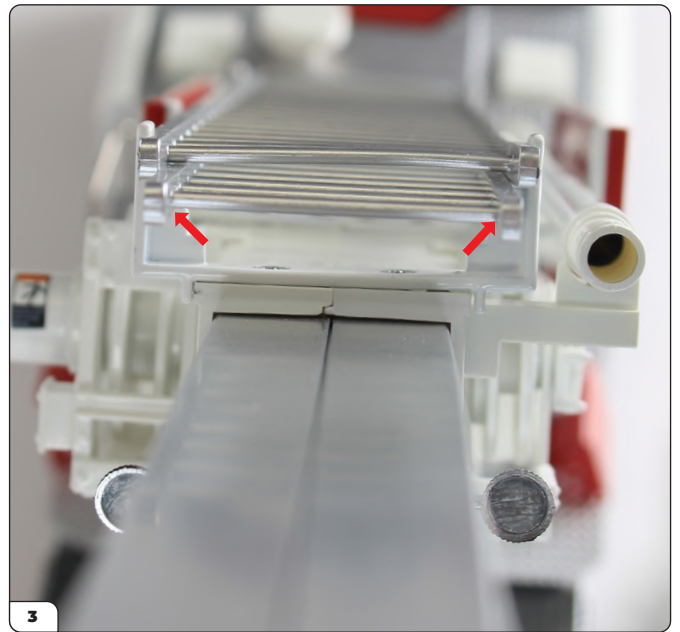
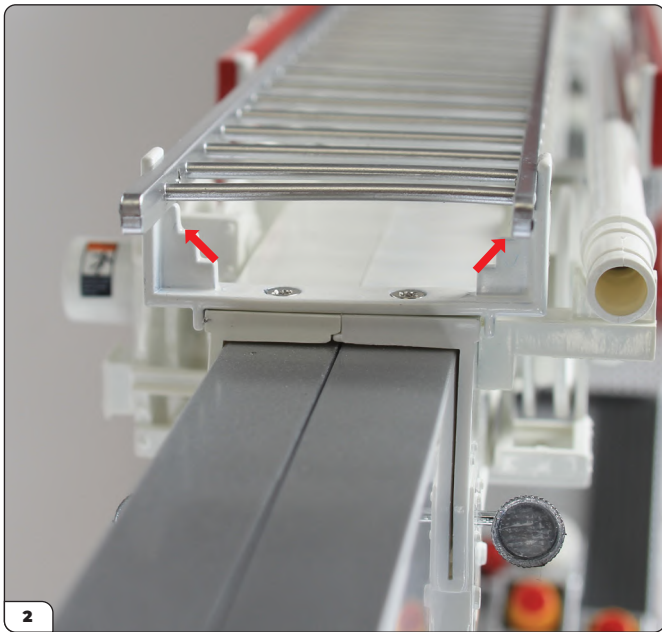

The lower midsection ladder will be fitted underneath the base section ladder. It will sit on the next level of the ladder bracket as shown in the two images above. In step 4, the ladder has been slotted into place.

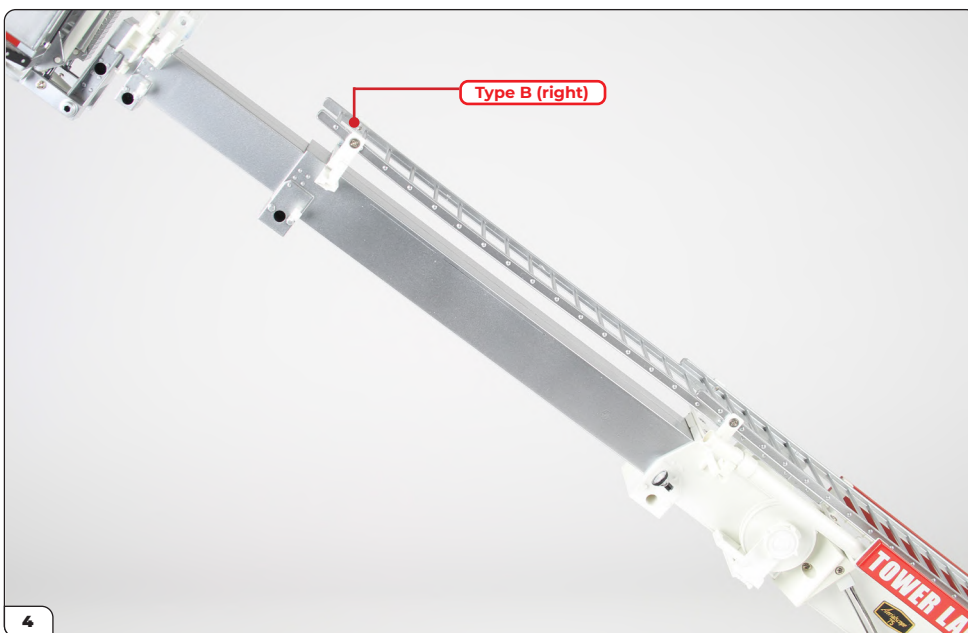

Extend the ladder until the screw holes on the top end align with the ladder bracket on the lower midsection. Secure the ladder to the bracket using 2 x type B screws (supplied from the pack of spares).

Stage 76: Aerial Lower Midsection Ladder and Waterway

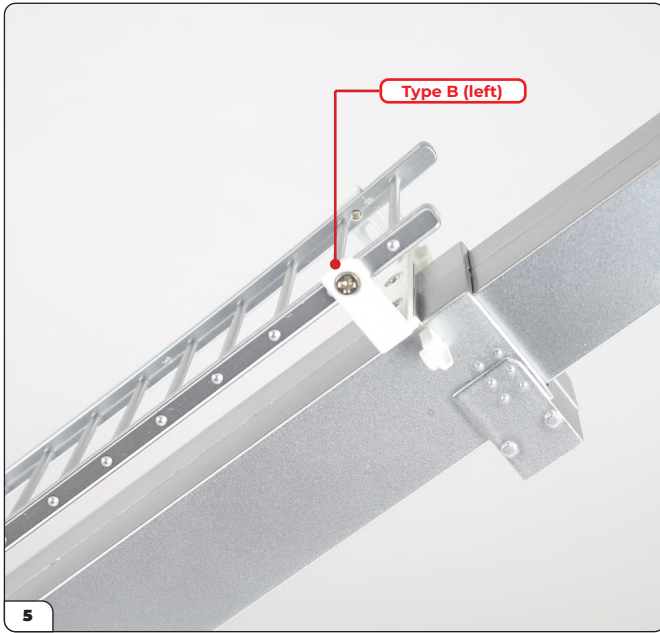

The next ladder has been fixed in place. The lower midsection waterway will now be attached in the same way as the previous waterway.



Start by inserting the smooth end of pipe into the base section waterway.

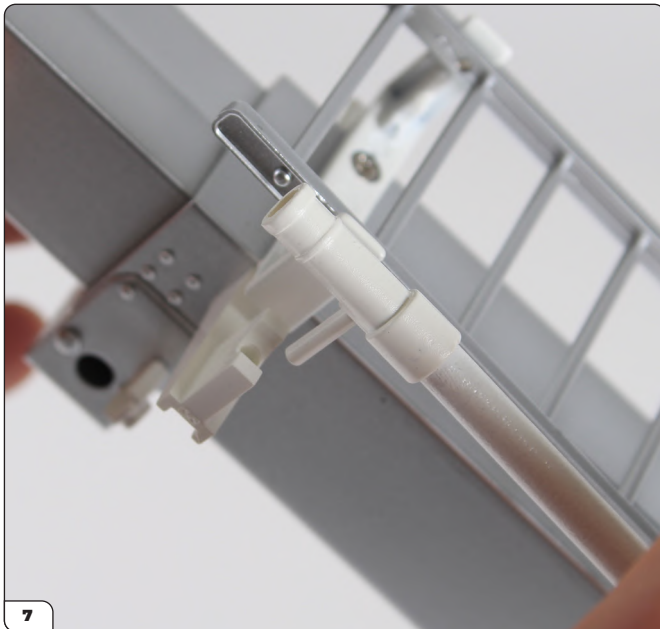

Anchor the top end of the pipe into the ladder bracket by pressing the pin into the corresponding hole.



The pipe should sit securely in the bracket, like this.

Stage 76: Aerial Lower Midsection Ladder and Waterway

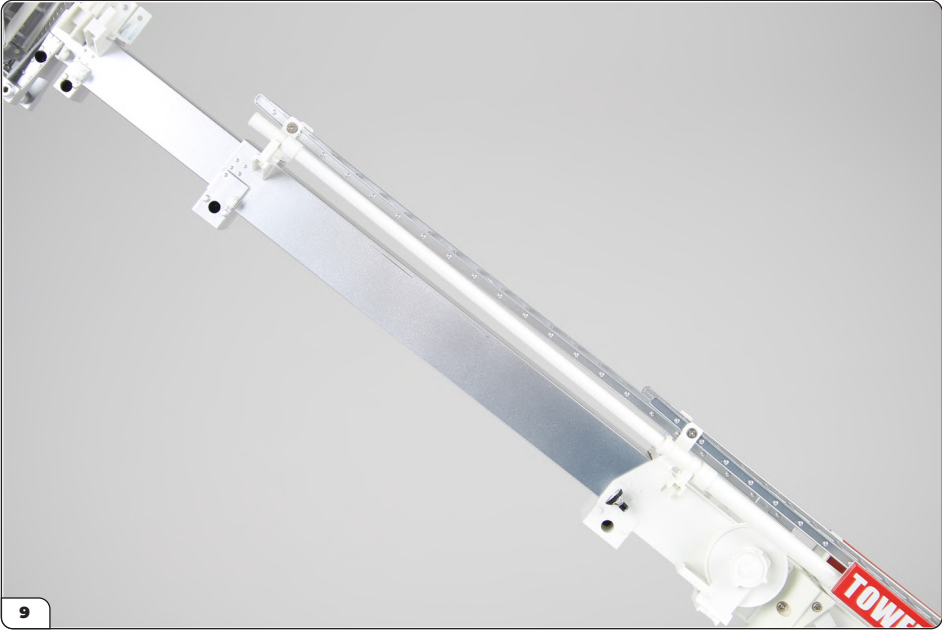

The lower midsection waterway is now in place.



Stage 77: Aerial Upper Midsection Ladder & Waterway

Now for the upper midsection ladder and waterway.



STAGE 77 PARTS LIST

Name
Upper midsection ladder
Waterway

Upper midsection ladder



Waterway



Stage 77: Aerial Upper Midsection Ladder & Waterway



Check that you have the ladder in the correct orientation, with the screw holes at the top, then insert the bottom end onto the ladder bracket underneath the previous ladder section.

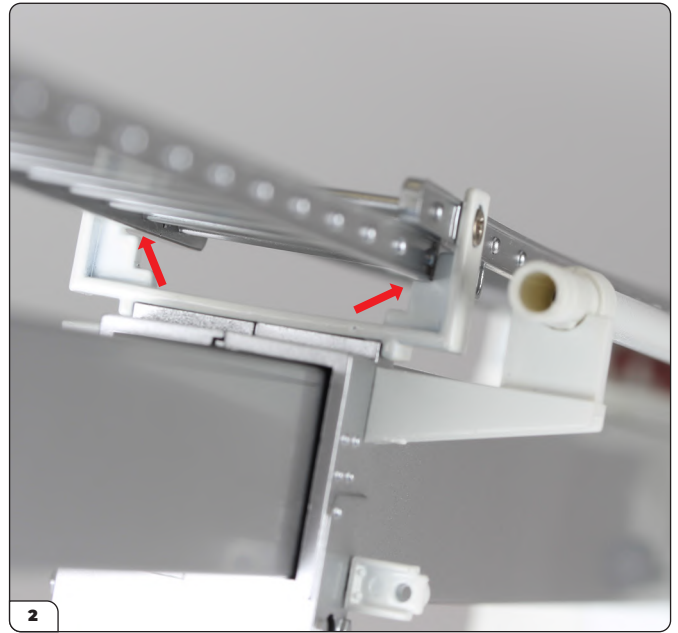

Slide the ladder into place on the second level of the ladder bracket.

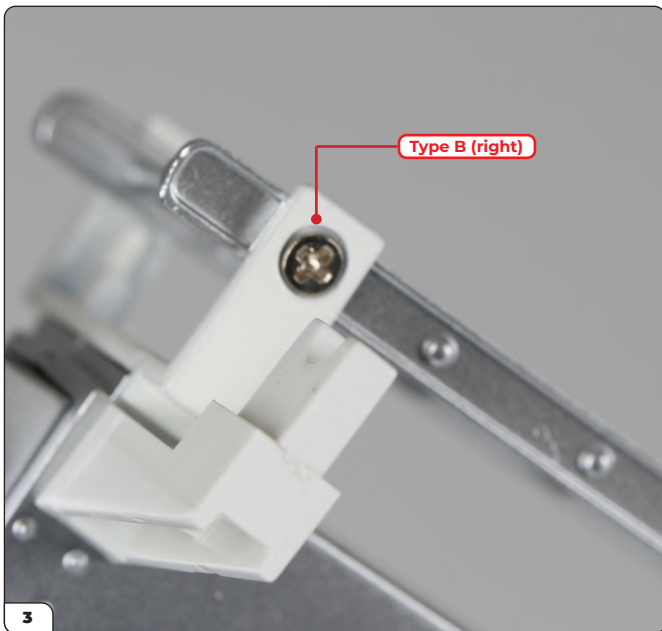

Extend the ladder again until the screw holes align with those on the ladder bracket at the top of the midsection. Secure in place using 2x type B screws (supplied from the pack of spares).

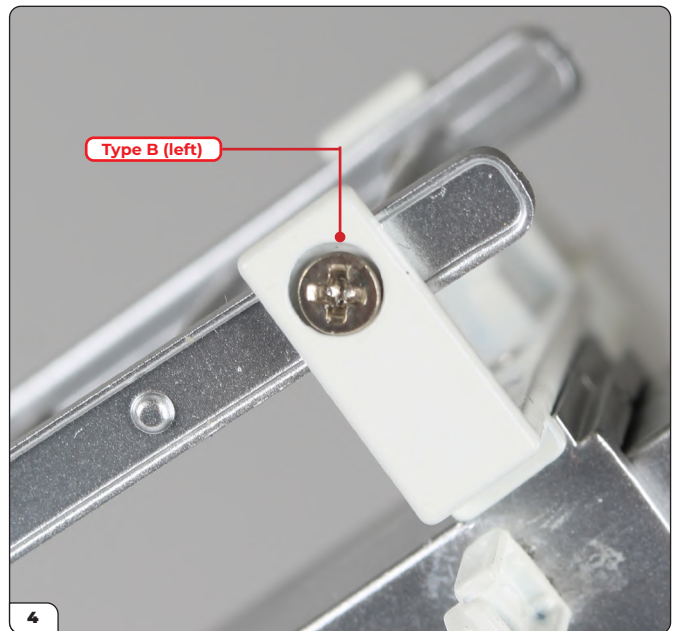

Stage 77: Aerial Upper Midsection Ladder & Waterway

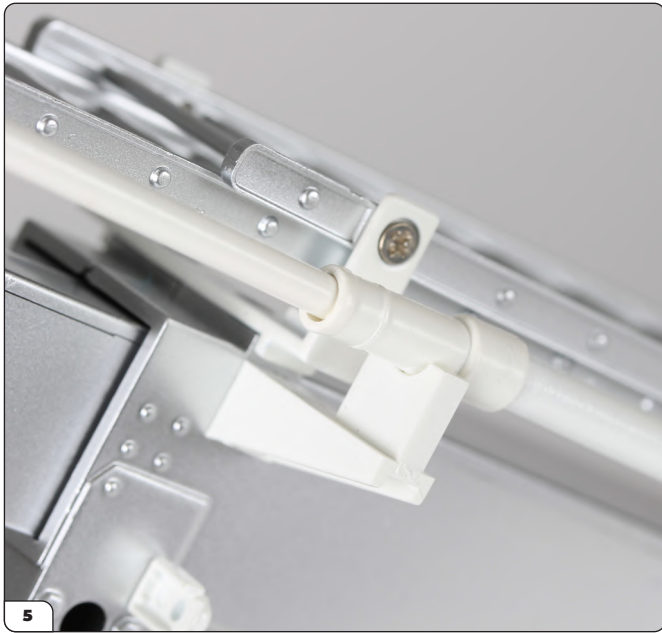

Fit the waterway in the same way as before. Insert the smooth end into the previous waterway.

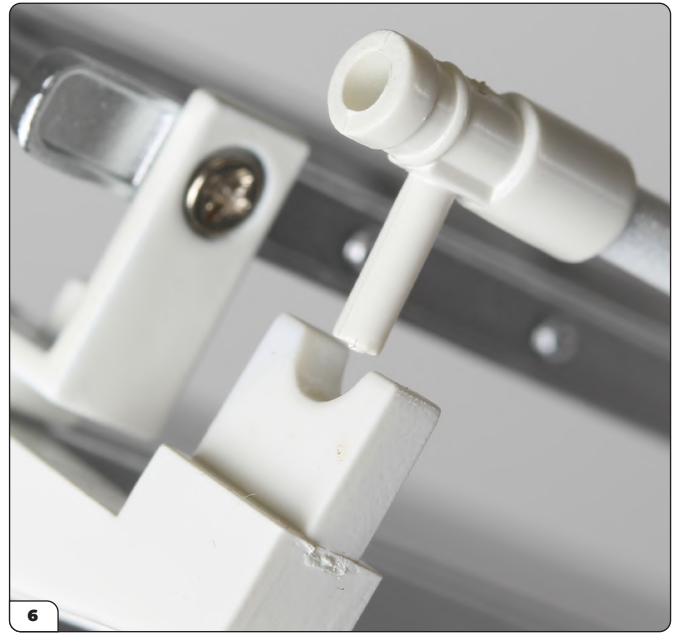

Anchor the opposite end into the ladder bracket.



The upper midsection waterway is now in place.

Stage 77: Aerial Upper Midsection Ladder & Waterway

STAGE COMPLETE



Stage 78: Aerial Fly Section Ladder & Waterway, and Adding the Final Details

And finally, the fly section ladder and waterway



STAGE 78 PARTS LIST

Name
Fly section ladder
Waterway

Fly section ladder



Waterway



Stage 78: Aerial Fly Section Ladder & Waterway, and Adding the Final Details



Check that you have the ladder in the correct orientation, with the screw holes at the top.

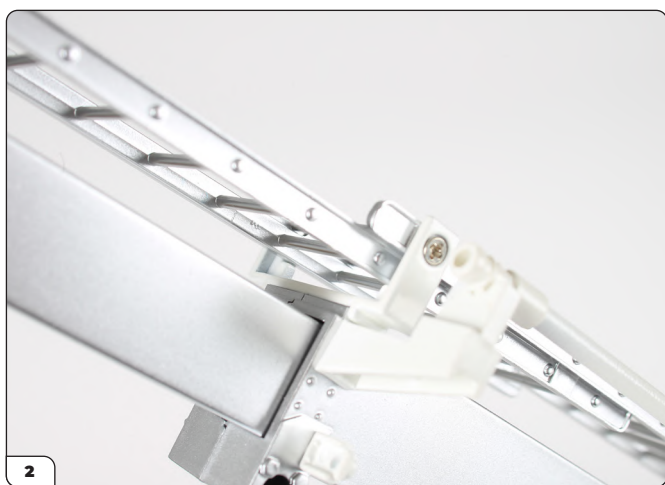

Insert the bottom end of the ladder onto the ladder bracket underneath the previous ladder section.

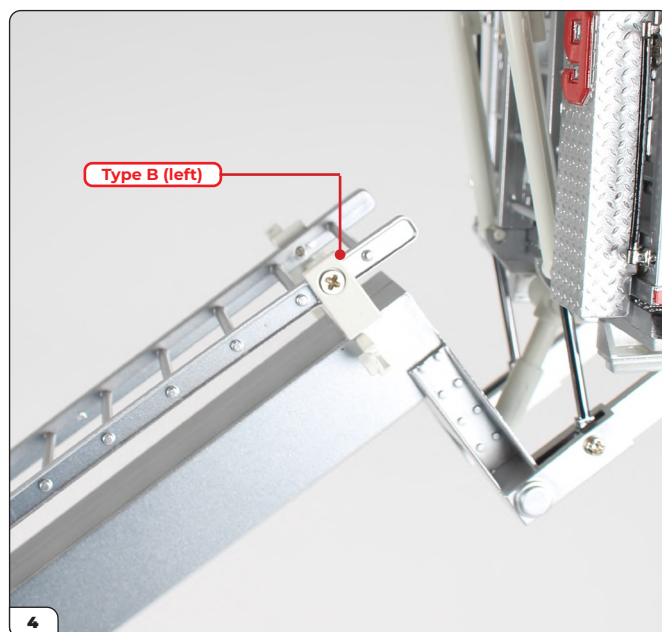
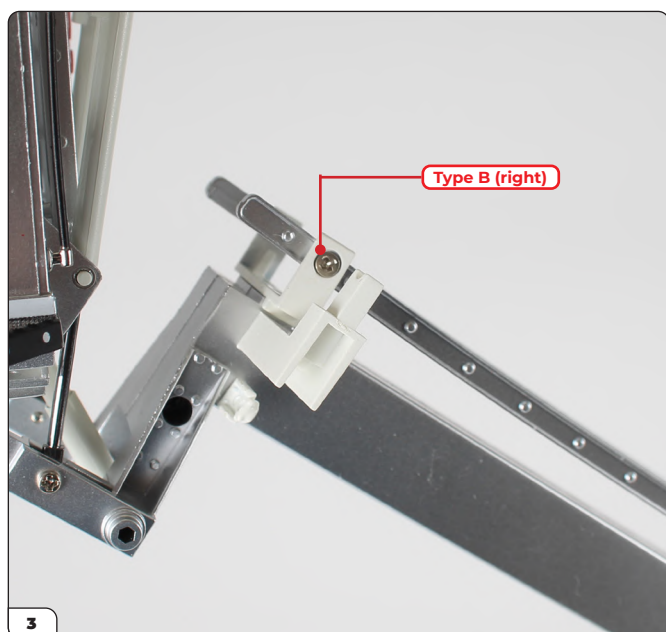

Extend the ladder again until the screw holes align with those on the ladder bracket at the top of the fly section. Secure in place using 2x type B screws (supplied from the pack of spares).

Stage 78: Aerial Fly Section Ladder & Waterway, and Adding the Final Details



Fit the waterway in the same way as before. Insert the smooth end into the previous pipe.

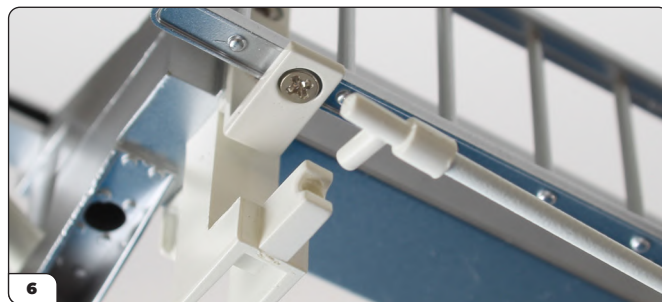

Anchor the opposite end into the ladder bracket.

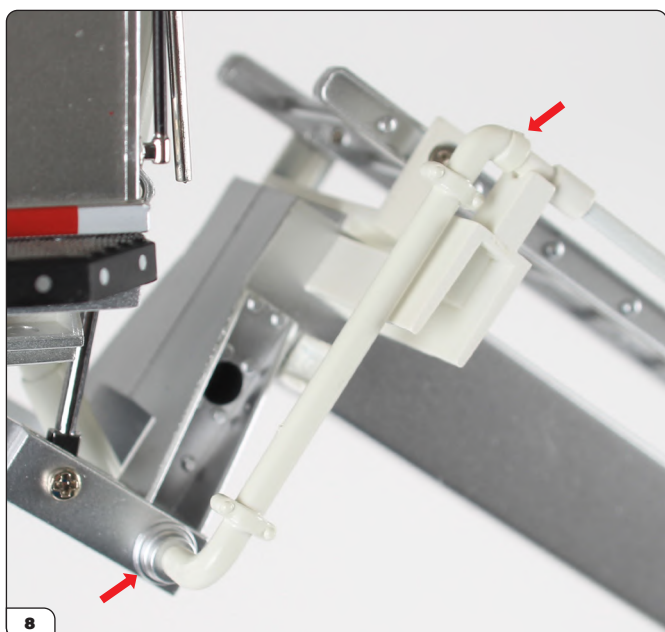

Fit **pipe a** from Stage 62 into the waterway attached in step 7 and the outlet on the fly section (arrows). This completes installation of the waterway.

Stage 78: Aerial Fly Section Ladder & Waterway, and Adding the Final Details



You'll now complete Ladder 9 by adding the final details supplied in various packs over the course of the build: Start by taking the rear spotlight from Stage 40 and push it into the small raised walkway above the jack.



Repeat on the opposite side, taking the rear spotlight from Stage 48.



Take the floodlight from Stage 20 and fix it into the small hole in the rear of the cab.



Repeat on the opposite side, taking the floodlight from Stage 17.

Stage 78: Aerial Fly Section Ladder & Waterway, and Adding the Final Details



Take the wiper from Stage 17 and fix it in place below the windshield as shown. Both left and right wipers are the same.



Repeat on the opposite side, taking the wiper from Stage 20.



Take the mirror from Stage 20 and fix it in place just below the windshield on the right-hand side.



The spotlight from Stage 21 is fixed above the front cab door on the right hand side.

Stage 78: Fourth Ladder & Long Water Pipe Section, and Adding the Final Details



The front bumper mirror from Stage 12 attaches to the roof, above the right-hand windshield.

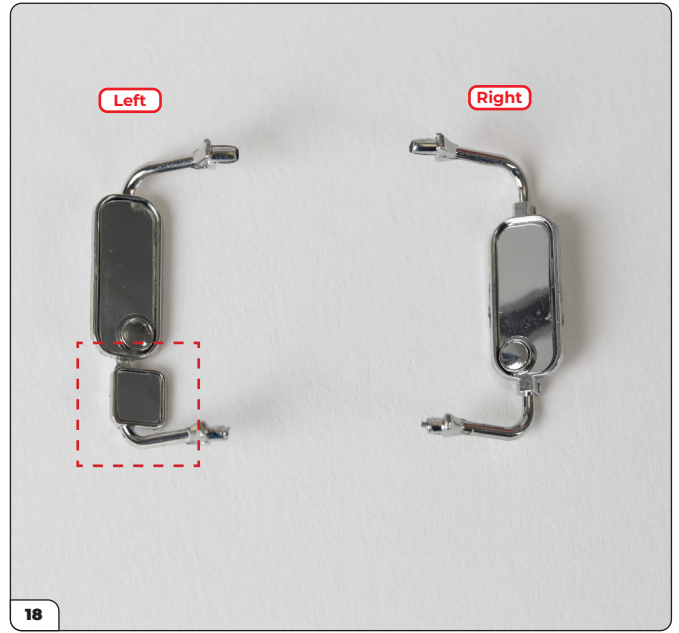

The wing mirrors were supplied in stage 16. Note that there is a left and a right wing mirror. The left-hand wing mirror, for the driver, has an extra mirror (highlighted above).



Fix the right-hand wing mirror in place, pressing it firmly into the two fixing points indicated above.



Repeat on the left-hand side to attach the driver's wing mirror.

Stage 78: Fourth Ladder & Long Water Pipe Section, and Adding the Final Details



The hose from Pack 1 is stored in the rear compartment on the left-hand side.



The rope from Stage 30 is stored in the rear compartment on the right-hand side.

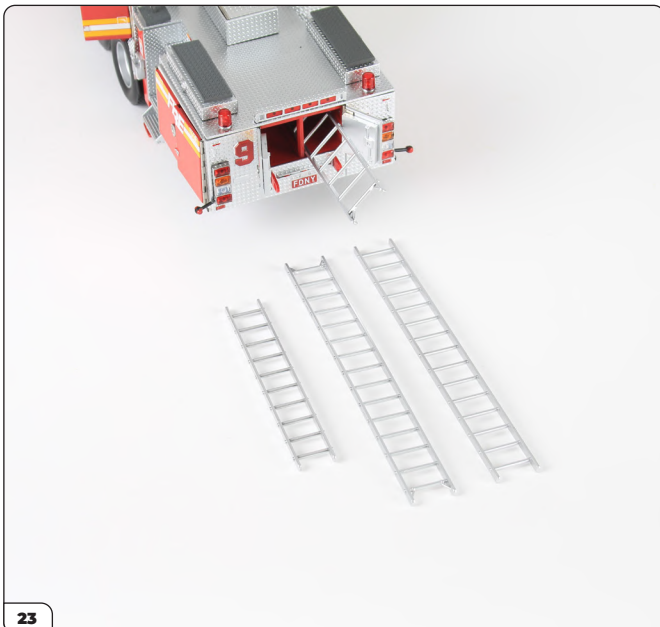

The 4x ladders from pack 8 are stored in the main body, accessed via the doors at the rear of the fire truck.



Store the ladders at a slight angle so they fit comfortably.

Stage 78: Fourth Ladder & Long Water Pipe Section, and Adding the Final Details



Your Ladder 9 Aerialscope Fire Truck is now complete!

We very much hope you have enjoyed this build. Don't forget, your enjoyment doesn't have to stop here. The first Pack of your next Agora model is absolutely free. You may decide now, or take your time to choose as vouchers to redeem your free pack are valid for 12-months. Keep an eye on our newsletters and the website for details of current and new releases.

If you haven't yet received your Free First Pack voucher, please contact us via the website.