



# FDNY®

## FIRE TRUCK TOWER LADDER 9



# Pack 06

## BUILD INSTRUCTIONS

**STAGE 38: REAR LEFT STABILIZER  
AND STEPS**

**STAGE 41: TWO-DOOR STORAGE  
COMPARTMENT & SHELF**

**STAGE 39: STORAGE COMPARTMENT INNER  
AND BATTERY COMPARTMENT**

**STAGE 42: PULL-DOWN STORAGE  
COMPARTMENT AND REAR LADDER-BAY  
DOOR**

**STAGE 40: REAR LEFT LIGHT CLUSTER, PCB  
AND ACCESSORIES**

**STAGE 43: TWO-DOOR TALL STORAGE  
COMPARTMENT WITH SHELF**

# Advice from the experts

---

 **Please keep ALL unused screws as they will be required in a later stage.**

Please make sure you don't mix up the screws. They look quite similar, but the threads do vary slightly. Using the wrong screws may damage the parts.

When securing parts together using multiple screws, fit each screw loosely to ensure all the parts are correctly aligned before gently tightening them firmly, but not overtight, in the order in which you placed them.

The screwdriver can be magnetized by stroking it with a magnet (fridge magnet, etc.) enabling it to hold the screws and make assembly easier.

If a screw is tight going into a metal part, do not force it as you may shear the head off. Remove it and put a tiny smear of Vaseline, soap or light oil on the thread. That will lubricate it and make it easier to drive home.

During the course of this build, you will receive many pieces that you will assemble immediately – following the instructions in the corresponding stage – and other pieces that you should store safely to one side, for use in future assembly stages.

Left and Right! When building your fire truck, the left or right hand side refers to each side as you are sitting in the cab.



**WARNING:** Some parts are assembled using magnets. These magnets can cause serious injury if they are swallowed. Keep away from children. If you suspect a magnet has been swallowed, seek medical help straight away.

# Stage 38: Rear Left Stabilizer and Steps

In this first stage of Pack 06, you'll build a set of steps used for accessing the platform, and install the rear left stabilizer. The Aerialscope stabilizers have a 'rods down' design and along with the two outriggers, are key to fast setup and stability.



## STAGE 38 PARTS LIST

Name
Rear left stabilizer
Step backplate
Step left side plate
Step right side plate
Stabilizer support plate
Step 3
Step 4
Step 2
Step 1
Step brackets
Step handle
Light lens
Light frame

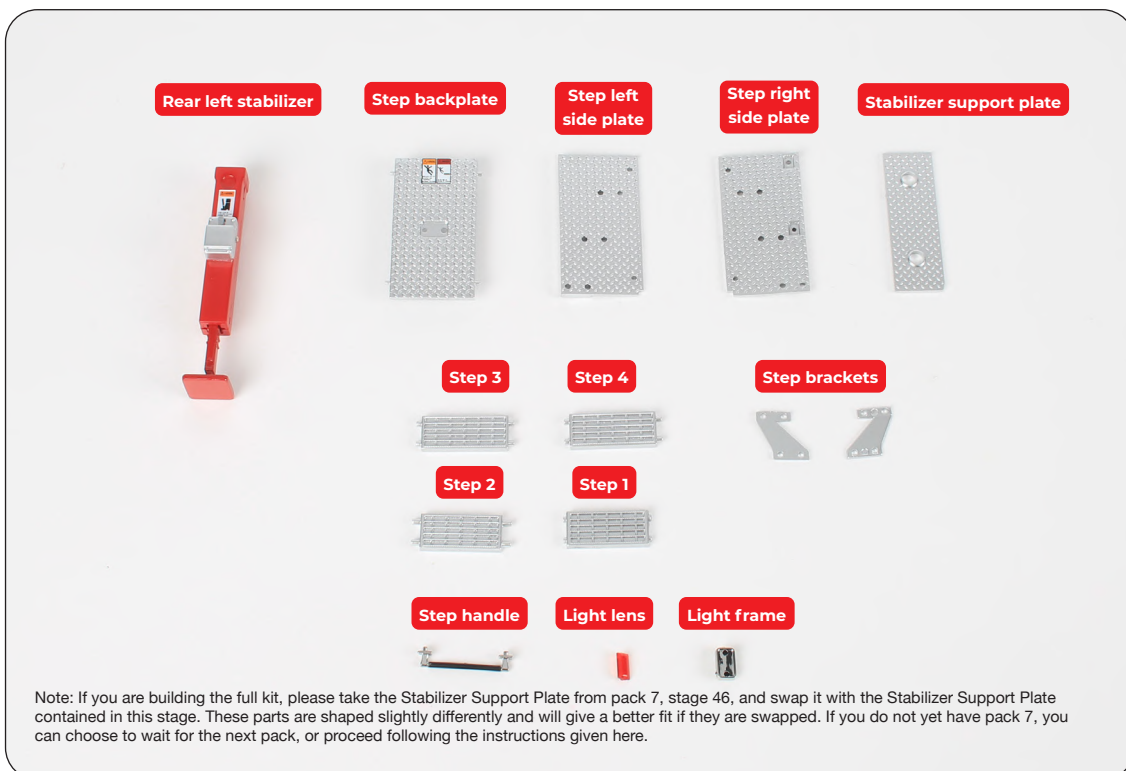

## Stage 38: Rear Left Stabilizer and Steps

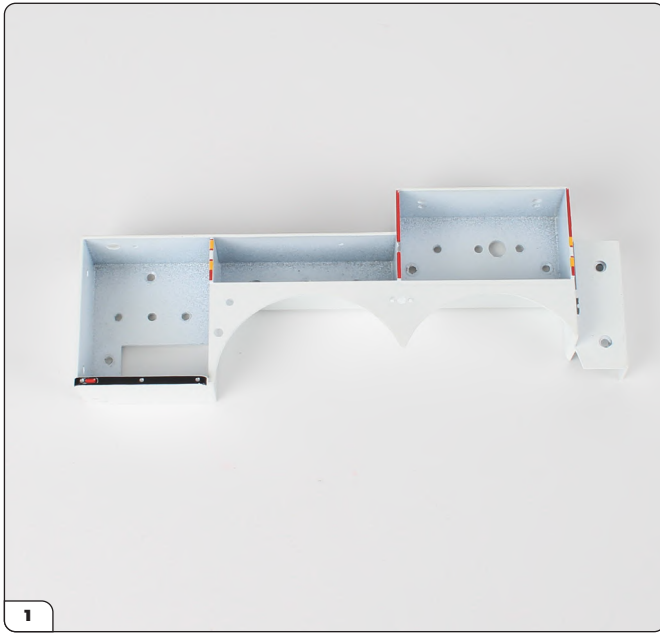

### INSTALLING THE REAR LEFT STABILIZER

You will also need the Storage Compartment Frame from Stage 32, the box frame shell from stage 36, Type H screws from stage 35, and Type D screws from stage 32.

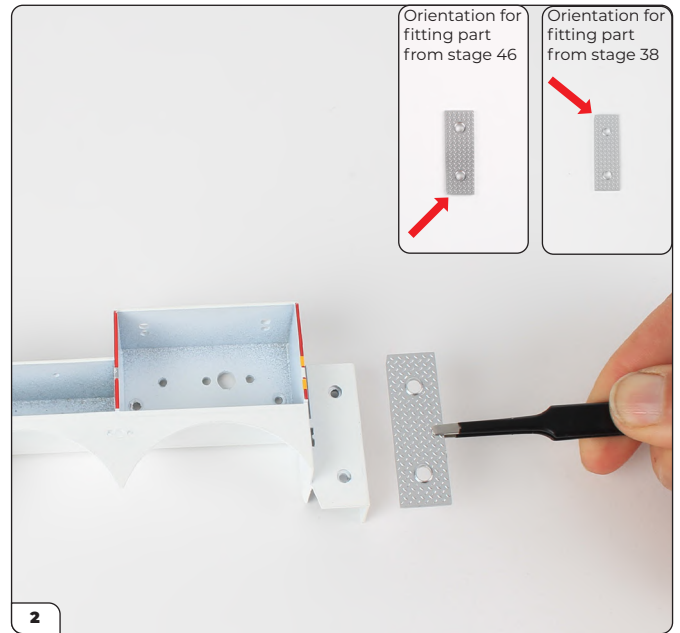

Take the stabilizer support plate and note that there is a tiny notch in one corner (inset). If you have swapped this part with stage 46, fit the notch at the bottom left, against the wheel arch. Otherwise, fit the notch at the top left, as shown in the inset pictures above. With the notch in position, align the plate on the end of the storage compartment frame.

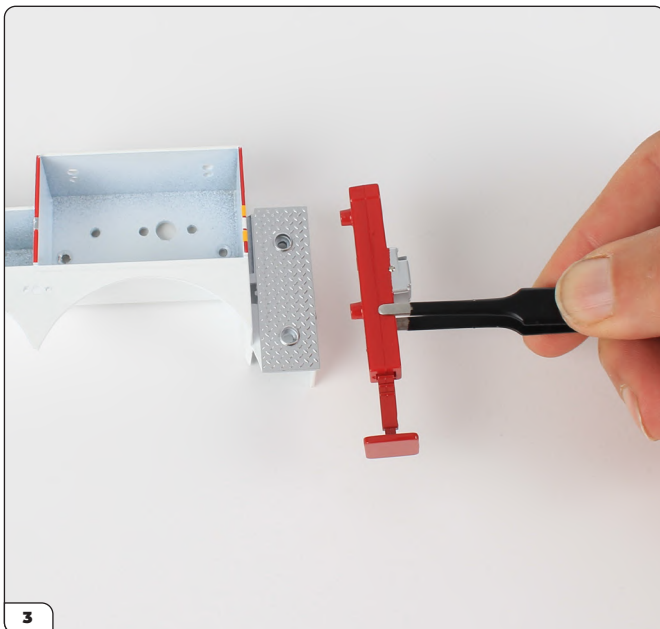

With the support plate resting in place over the two fixing points, position the left stabilizer on top so its lugs project into the fixing holes.

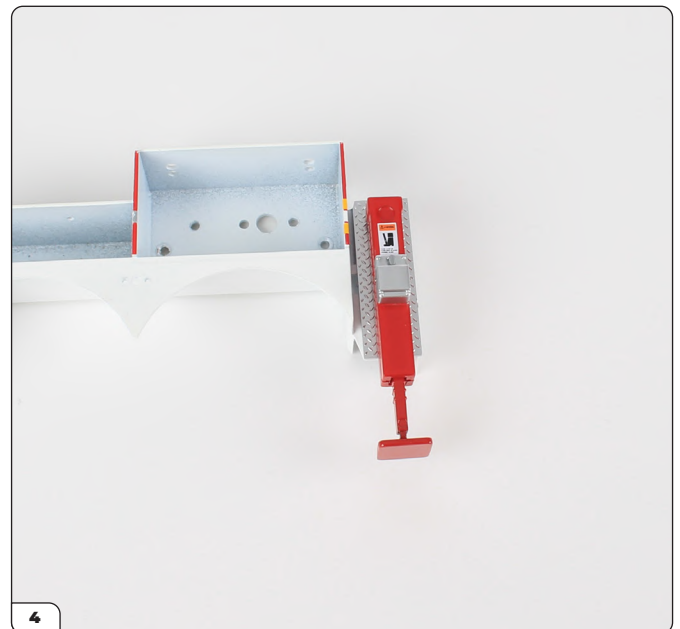

Hold the components in place as you turn the frame over to fix everything from the opposite side.



## Stage 38: Rear Left Stabilizer and Steps

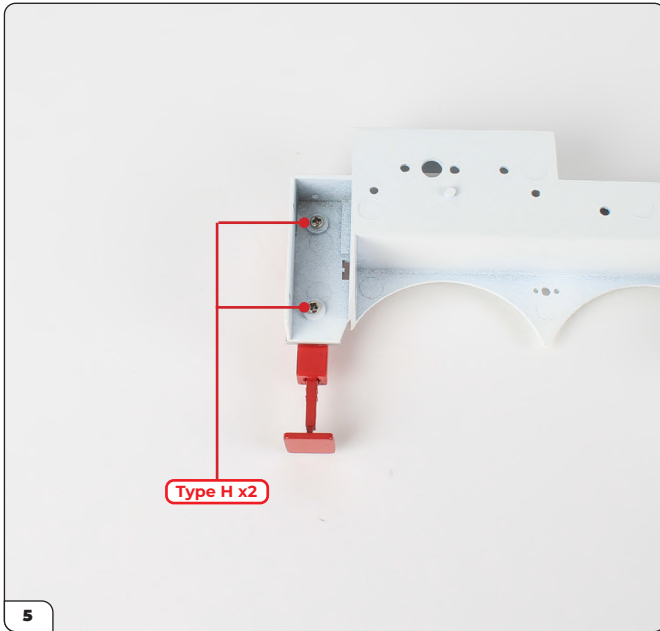

Fix the stabilizer in place using 2 x Type H screws from stage 35.

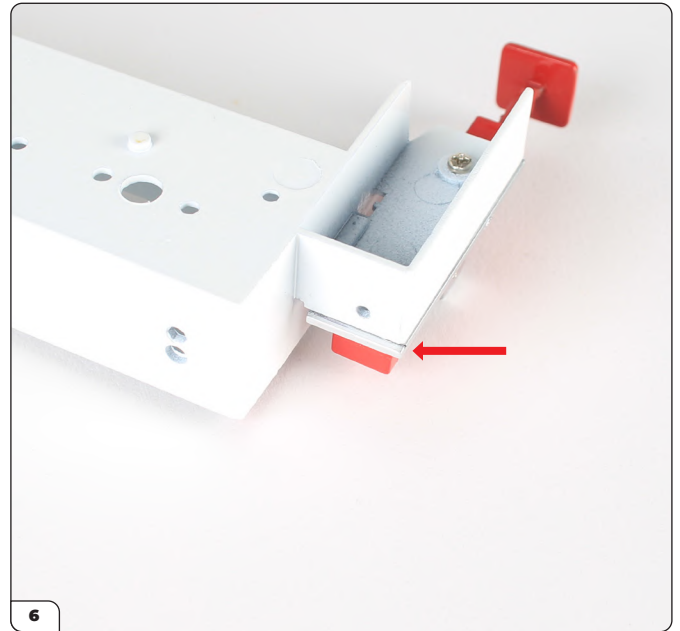

If you have swapped your support plates, skip steps 7 – 9 and move straight to step 10. If you haven't swapped parts, you will notice that the stabilizer support plate projects above the storage compartment frame, as shown above. This projecting edge will need to be trimmed flush to the frame.

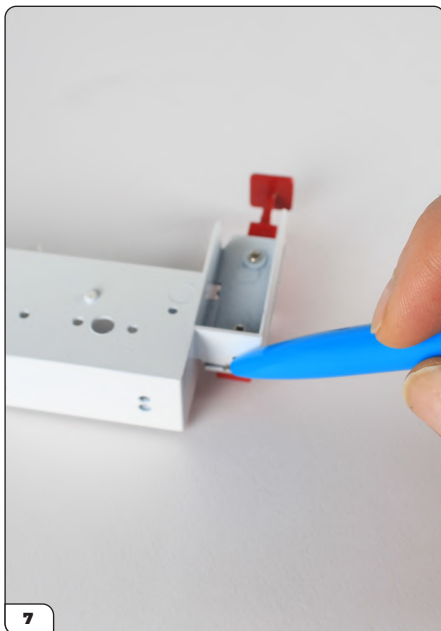

Start by making a line where the plate needs to be trimmed. Remove the 2 x H screws used in stape 5 and completely remove the plate. Keep the screws safe.

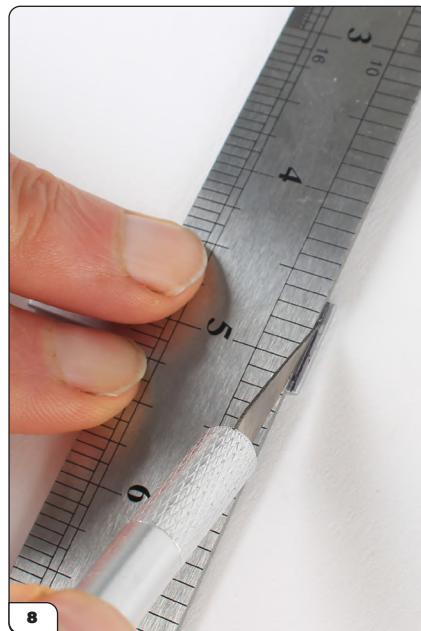

Using a steel rule and strong blade, cut along the line to remove the projecting area.

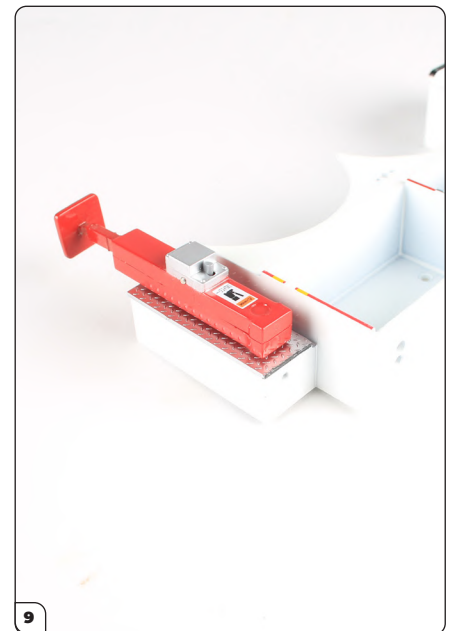

Repeat steps 2–5 to reattach the plate to the compartment frame. Check the plate is now flush. This will allow a good fit for the roof in pack 7.

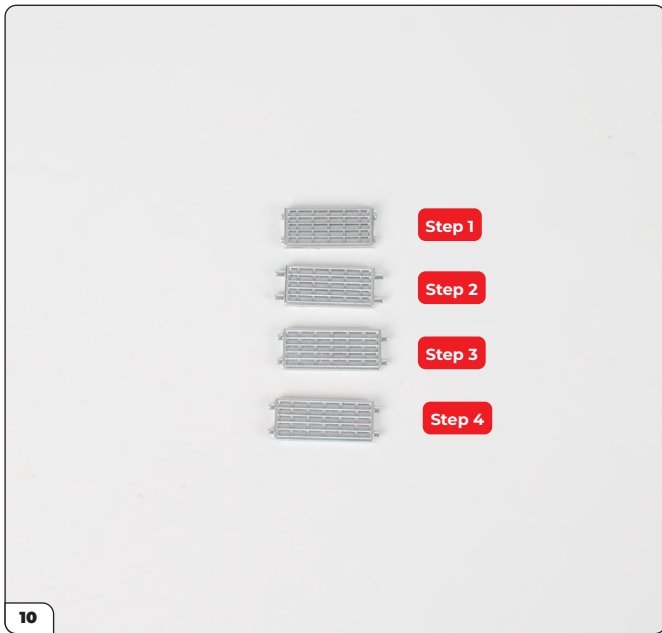

Take the four steps and note the differences in their size and their lugs: Step 1 has very short lugs; Step 2 has long lugs, Steps 3 & 4 are identical.  
Tip: scrape excess paint off the lugs as necessary when you fit them.



Take Step 1 with the very short lugs and align them with a step bracket in the orientation shown. Apply a drop of glue to the lugs before pushing them into the holes in the bracket as shown.

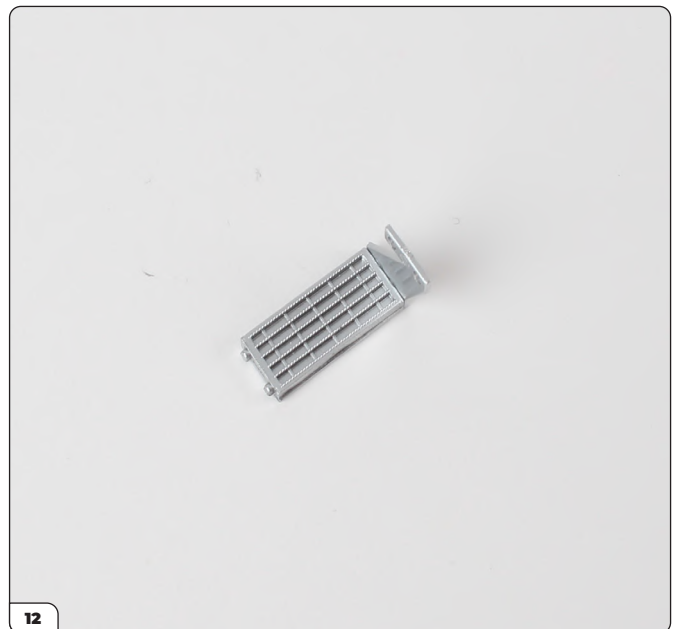

The long rectangular tab of the bracket should be further away from the step, as shown in this and the next photograph.

## Stage 38: Rear Left Stabilizer and Steps



Take Step 2 with the longest lugs and push them into the free end of the bracket, above step 1. Check that the grids on the steps face the same direction.



Fix the remaining step bracket to the opposite end of the steps, checking the orientation mirrors the first bracket.

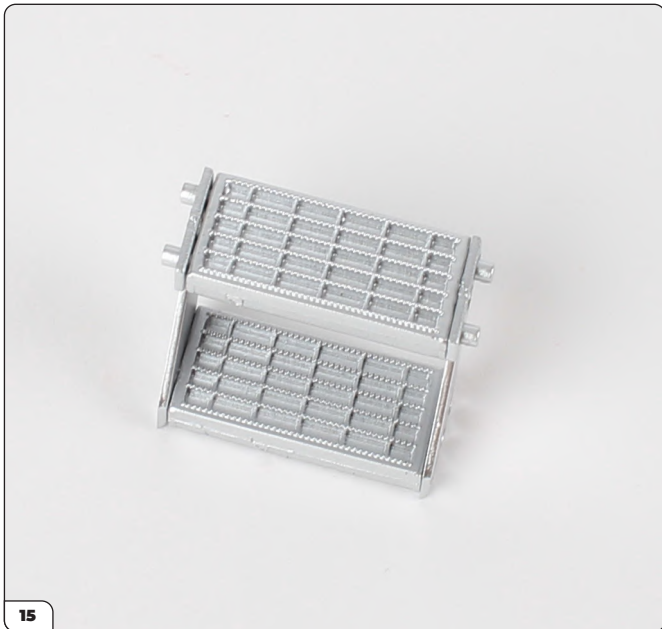

The two bottom steps should look like this.

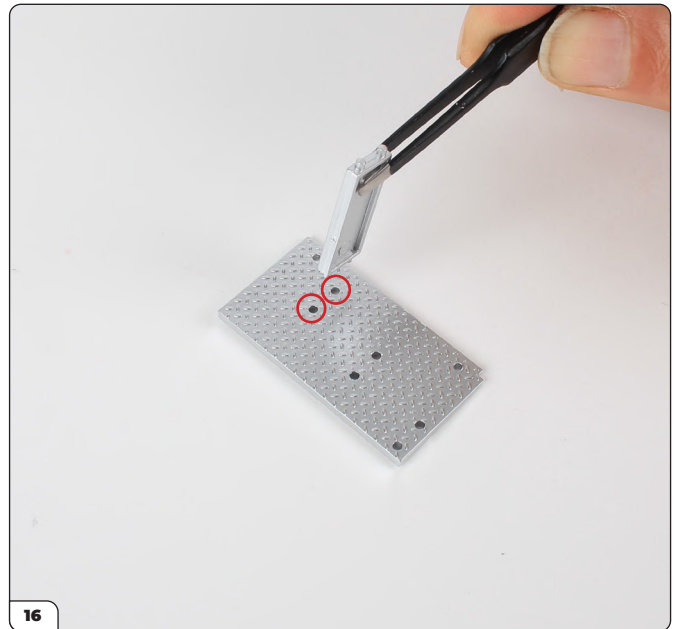

Next, take step 3 (3 & 4 are identical) and push it into the holes in the left step side-plate (circled) .

## Stage 38: Rear Left Stabilizer and Steps



Then take step 4 and push it into the left step side plate, just below step 3.



The longer lugs on step 2 can now be pushed into the holes along the bottom edge of the side plate. Again, check you have the correct orientation with the steps 'climbing' in the same direction.

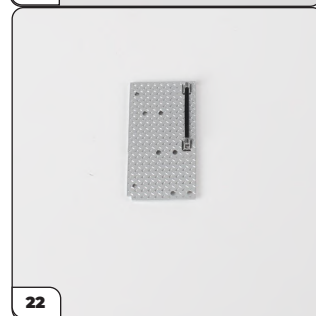
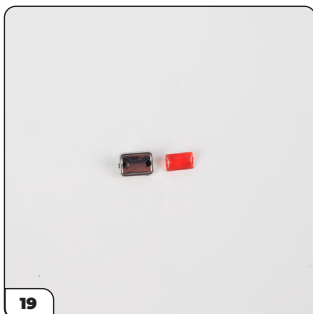

Assemble the light by pushing the light lens into the light frame, then push the assembled light unit into place on the back plate (11). Then, fix the handle to the right side plate. Apply a little glue to keep the components in place.

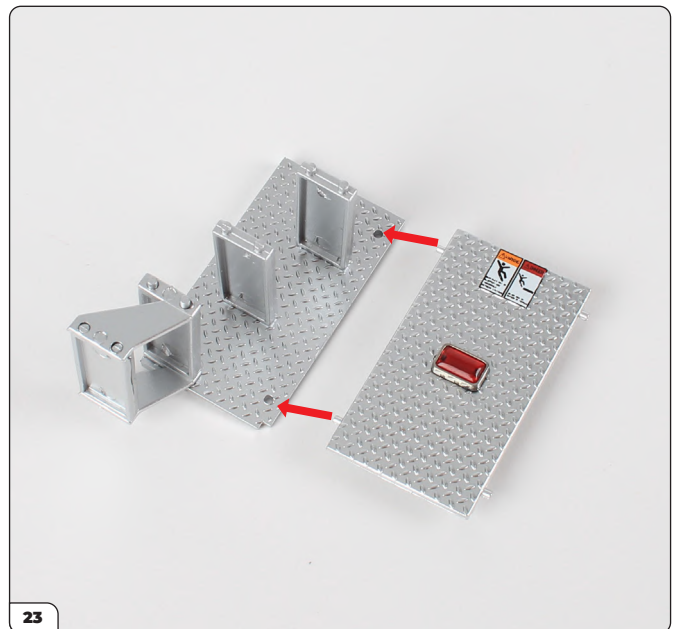

Align the back plate with the step assembly. Glue the lugs and along the edge of the back plate.



## Stage 38: Rear Left Stabilizer and Steps

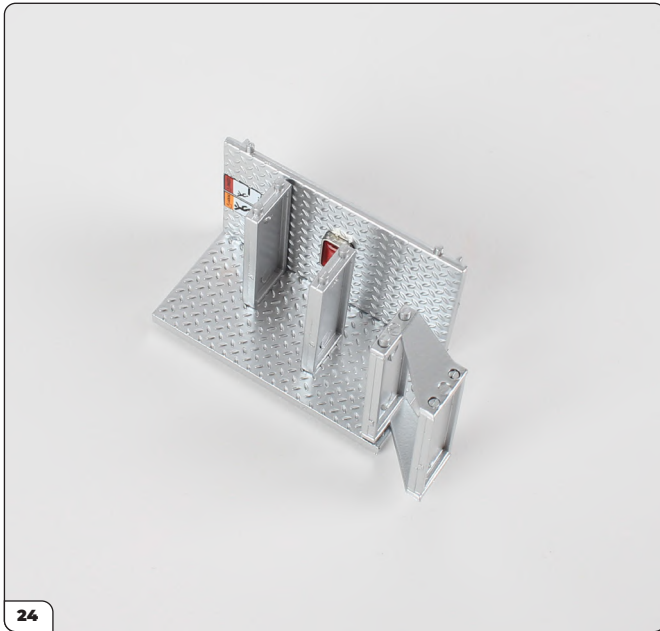

Push the plates together.



Take the right hand side plate and, with the handle facing inwards, press into place fitting over the lugs on the back plate and the three upper steps. Use a little more glue to ensure a good fix.



### ATTACH THE STORAGE COMPARTMENT FRAME TO THE BOX FRAME SHELL

Lay the box frame shell on its side and mount the storage compartment on top, aligning the pegs on the back of the frame with the holes in the shell. You will have the correct position if the pair of screw holes circled above are aligned.

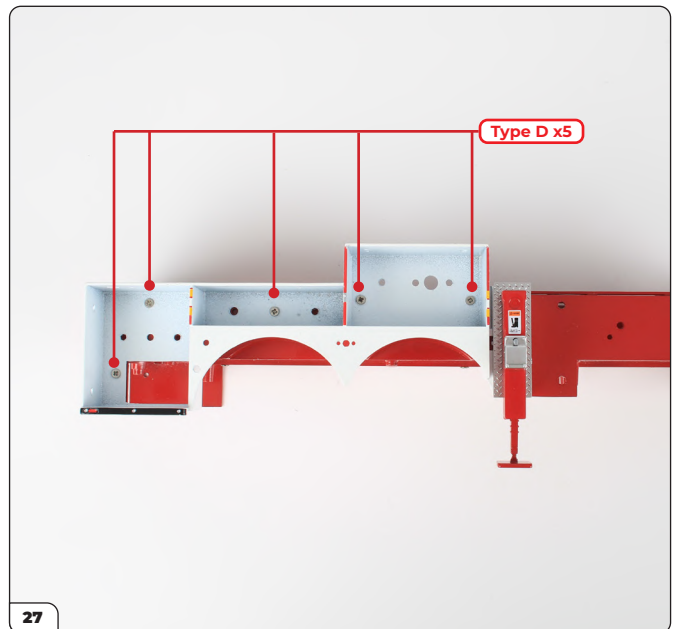

Secure the compartment frame in place using 5 x Type D screws from stage 32. Because these are very shallow screws, apply some glue to the tip of each screw before fixing to ensure a secure hold.

## Stage 38: Rear Left Stabilizer and Steps

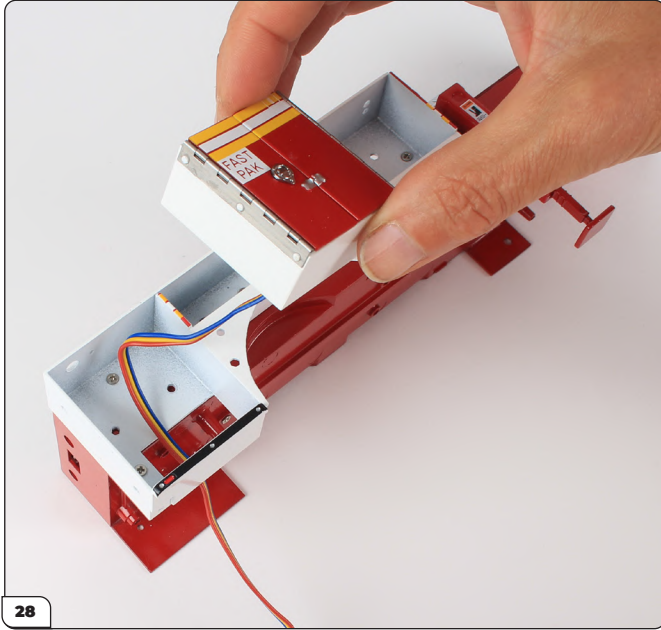

Take the compartment assembly containing the fire extinguisher from stage 31, and push it into the left side of the compartment frame, feeding the plug on the switch through the opening in the back.

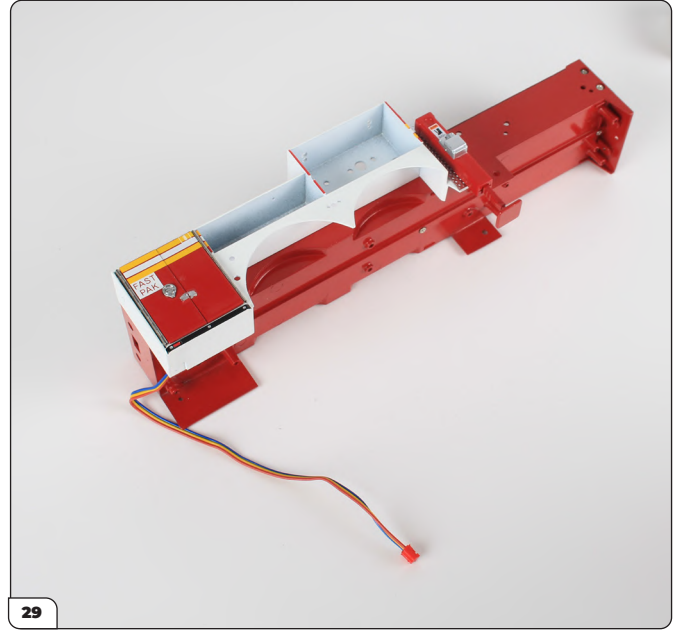

Pull the cable through and fit the compartment so the doors are flush to the frame.

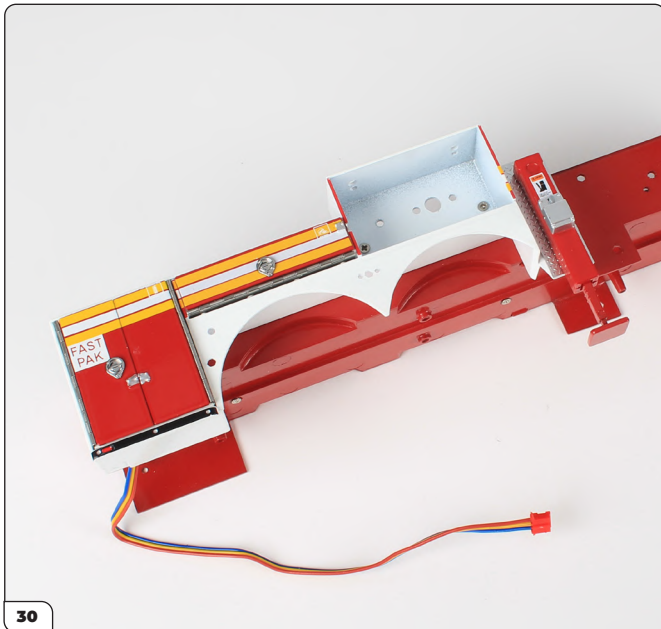

Fit the long, narrow compartment from stage 36 to the centre of the frame in a similar way. Check that the hinge is along the bottom and the door opens by pulling downwards.

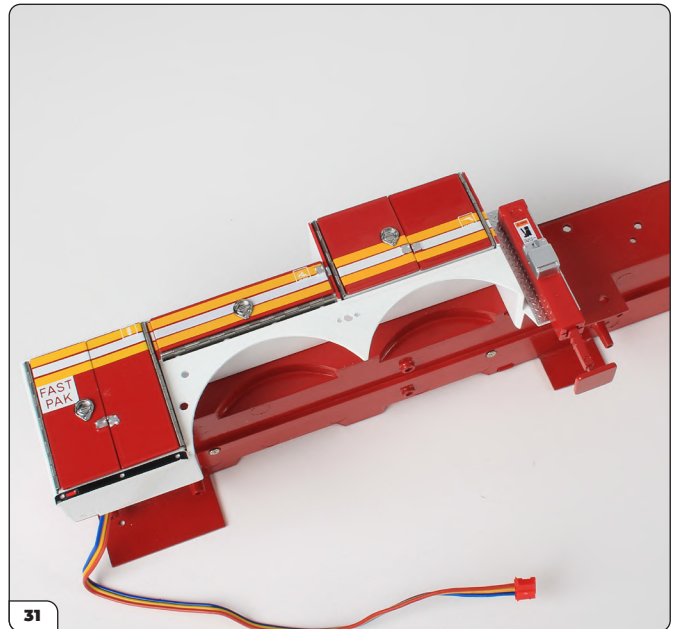

Lastly, fit the first compartment you built in stage 07 next to the stabilizer, checking the doors fit flush to the frame.

# Stage 38: Rear Left Stabilizer and Steps



# Stage 39: Storage Compartment Inner and Battery Compartment

In the next few stages, you will assemble more of the storage compartments with tool boards and adjustable shelves that allow the Aerialscope to house the vital equipment required for every unique set of rescue conditions.



## STAGE 39 PARTS LIST

Name
Compartment inner
Cable ties
Battery compartment bottom
Battery compartment top
Type D screws x2
Type J screws x3
Type I screws x1

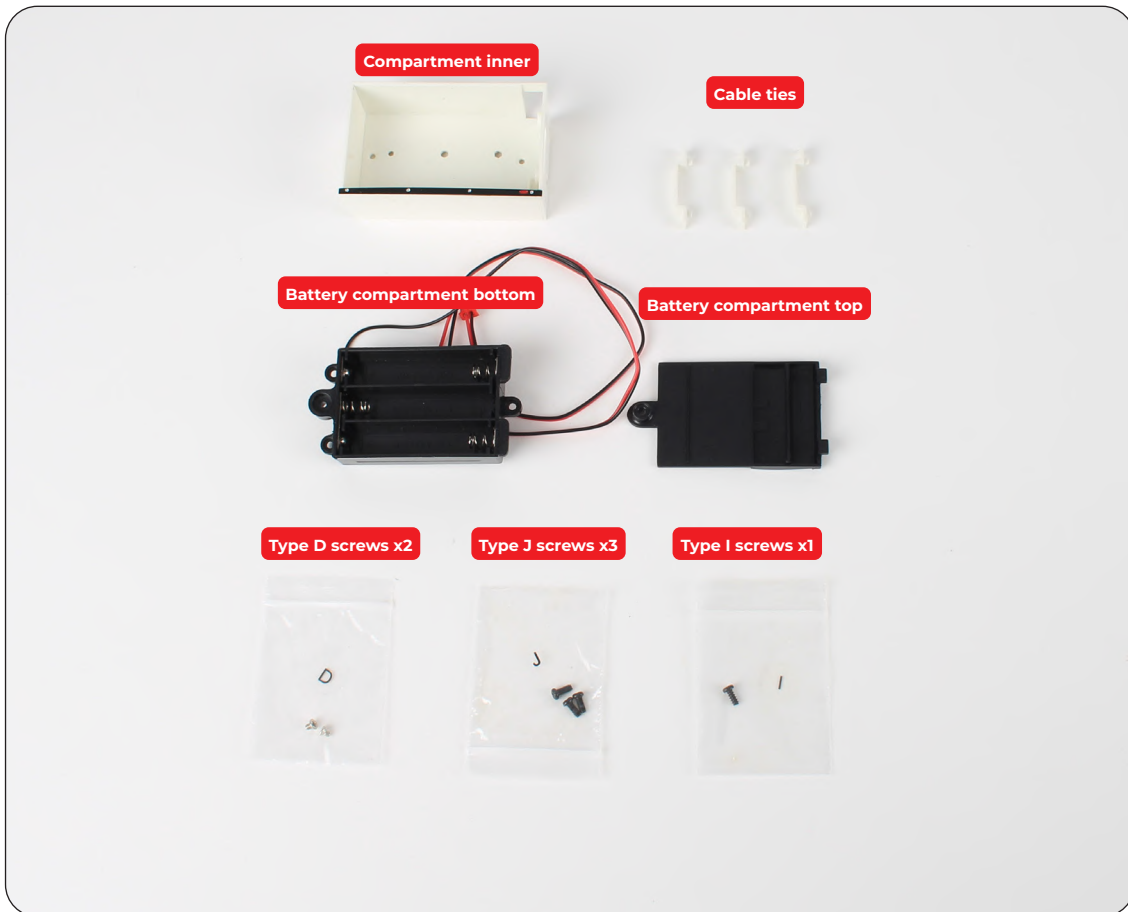



# Stage 39: Storage Compartment Inner and Battery Compartment

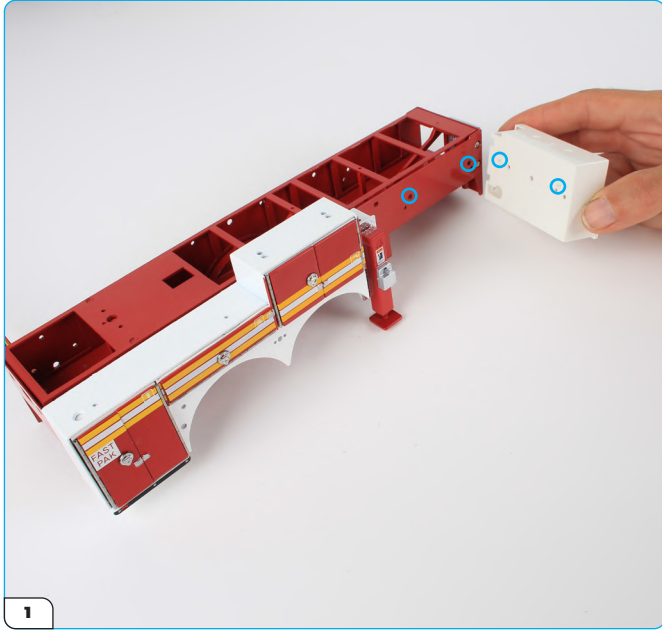

### ATTACH THE COMPARTMENT INNER

Continuing along the same side of the box frame as stage 38, align the two lugs on the compartment inner with those on the frame (circled).



Fix the compartment in place using 2 x Type D screws. Apply a drop of glue to the end of each screw before driving them into place.

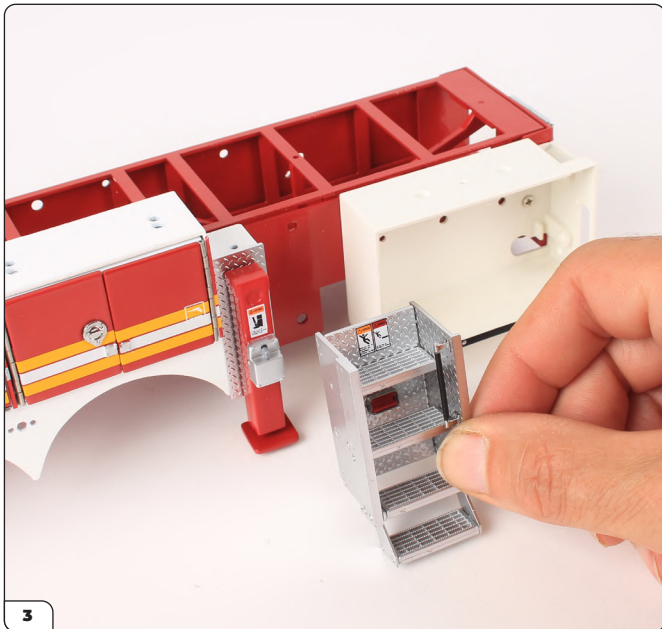

Take the set of steps assembled in stage 38 and push them into the gap between the stabilizer and the compartment inner, locating their lugs in the corresponding holes on the frame. You may need to scrape any excess flash from the lugs to ensure a good fit.



The steps sit snugly in place.



# Stage 39: Storage Compartment Inner and Battery Compartment

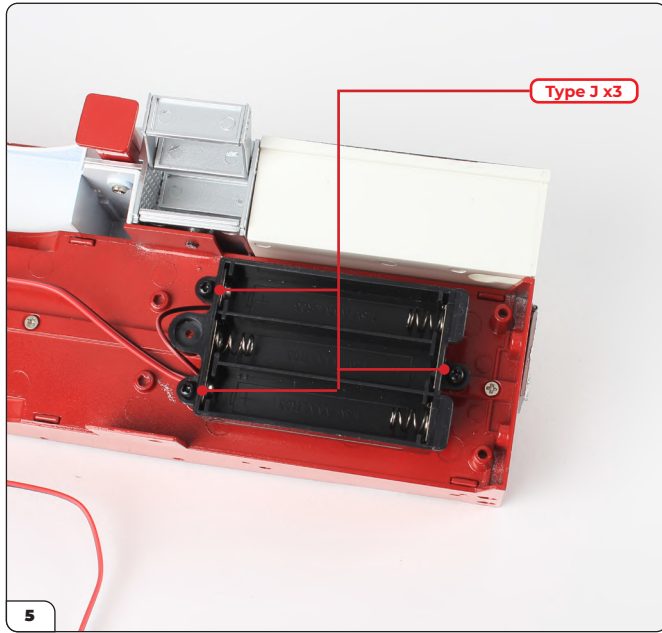

Turn the box frame so the underside is facing up and locate the battery compartment bottom on top of the three screw holes. Secure in place using 3 x Type J screws.

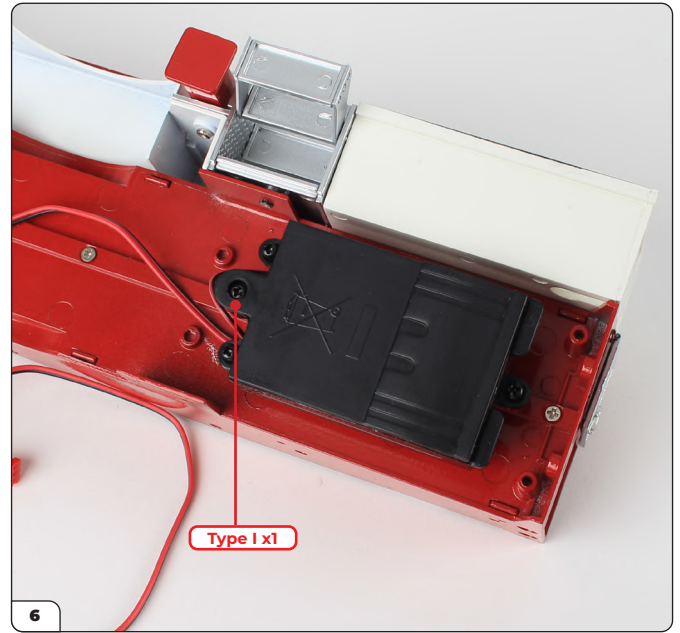

Position the battery compartment top on top and secure it with 1 x Type I screw.

## STAGE COMPLETE



# Stage 40: Rear Left Light Cluster, PCB and Accessories

Next, you'll assemble a light cluster for the rear of Ladder 9 before attaching another compartment and a tool. You'll also assemble the trio of lights that will eventually be fixed on top of the stabilizer.



## STAGE 40 PARTS LIST

Name
Light cluster PCB
Pickaxe
Axe
Fire extinguisher
Rear spotlights
Spotlight lenses x3
Rear left light cluster
LED diffusers x3
Light lenses x4
Type M screw x1



## Stage 40: Rear Left Light Cluster, PCB and Accessories

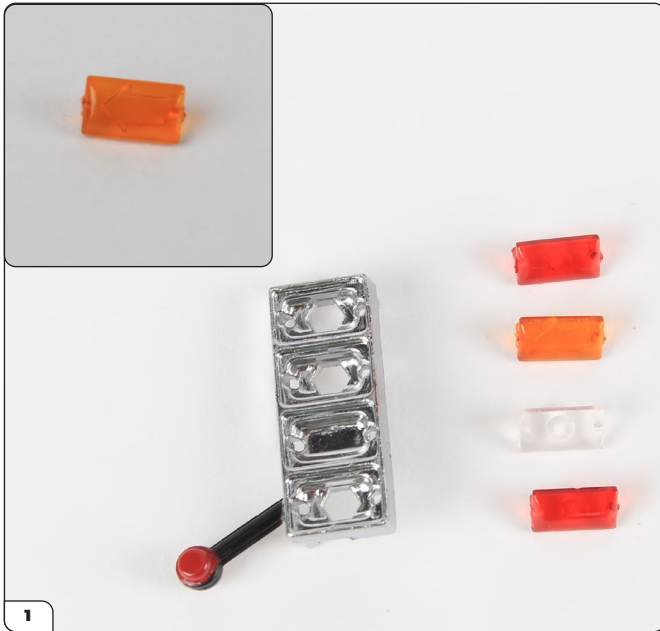

### ASSEMBLING THE LIGHT CLUSTER

Take the rear left light cluster and the four lenses. Line them up ready to fix in place as shown to ensure the correct order. Check that the directional arrow is facing left (inset). Apply a little PVA glue (which dries transparent) to the lugs of each lens before fixing them in place. Refer to the next image.

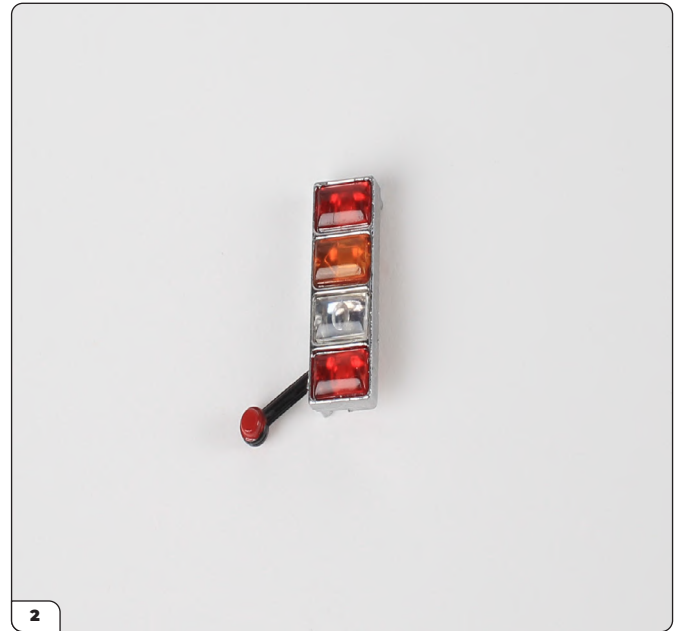

The rear lights function as follows: (from the bottom up) bottom red LED = warning light; clear LED = back up; Amber LED = arrow signal light; top red LED = brake/ tail light.



Turn the light cluster over and place an LED diffuser in the red and amber holes.

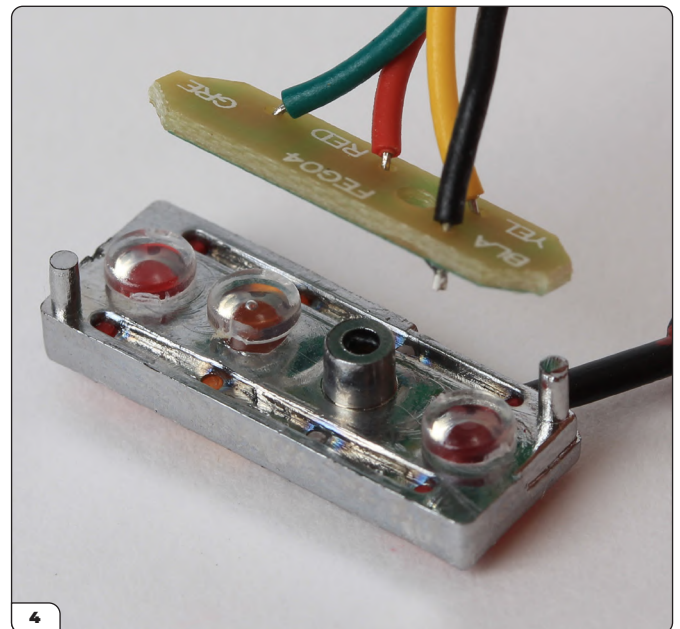

Lower the light cluster PCB over the LED diffusers.



## Stage 40: Rear Left Light Cluster, PCB and Accessories

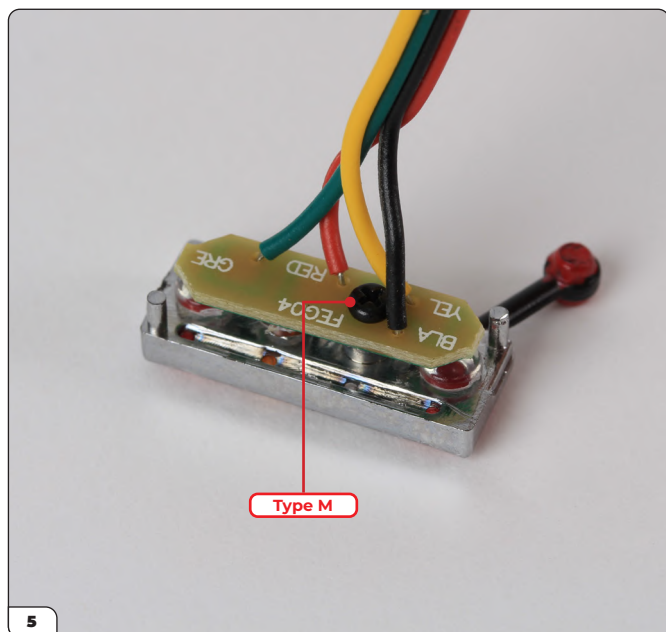

Secure the PCB in place with the Type M screw.

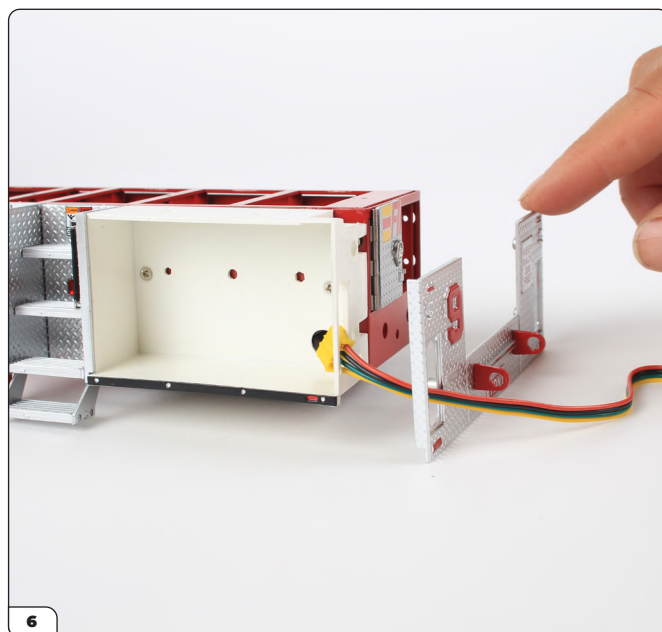

Take the rear panel from stage 02 and line it up with the rear of the box frame. Feed the plug end of the PCB through the rear panel, and through the opening in the compartment.

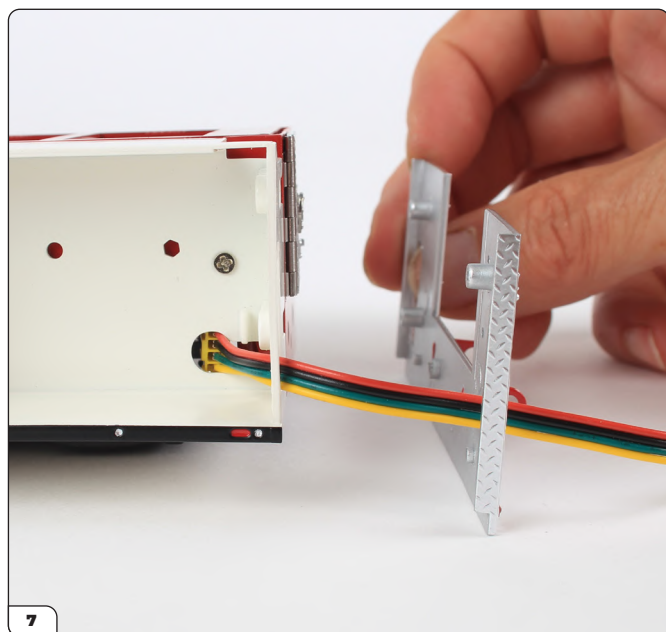

Continue to feed the plug back out through the round hole in the bottom right corner of the compartment.



Pull the cable through as far as it will go until the PCB is held against the rear panel. Push this left side of the rear panel fully into place on the box frame, but leave the right side detached (see next image).

## Stage 40: Rear Left Light Cluster, PCB and Accessories



Keep the right hand side of the rear panel detached.



Pull the cable of the PCB tight and push the light cluster fully into place so they sit flush on the rear panel.



Gently push the PCB cable into the corner of the compartment inner, and prepare the storage compartment assembled in stage 37.



Gently push the storage compartment in place until the doors are flush to the compartment inner frame.



## Stage 40: Rear Left Light Cluster, PCB and Accessories

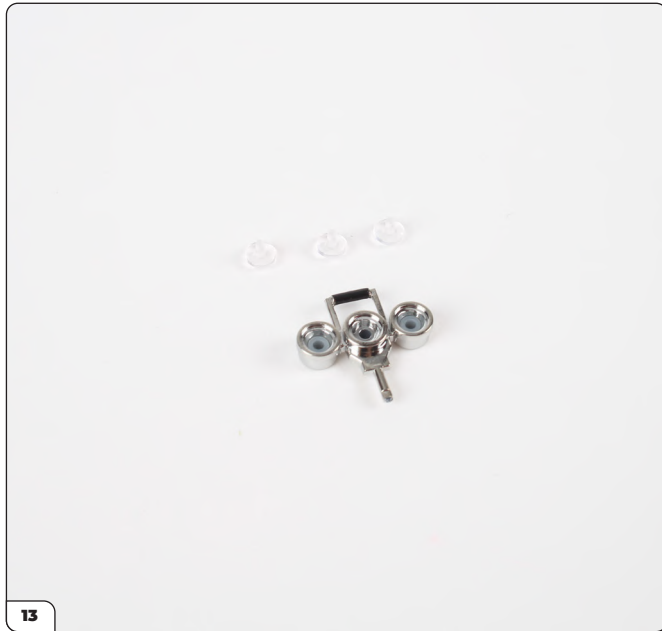

13 Take the rear spotlight unit and the three lenses.



14 Apply a little PVA glue around the circular recesses before dropping the lenses into place.

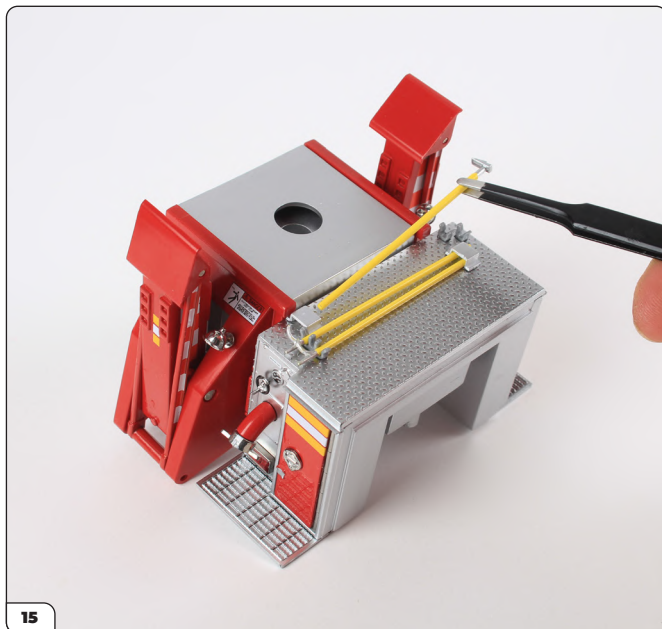

15 Fix the pickaxe to the midsection base, next to the pike poles.

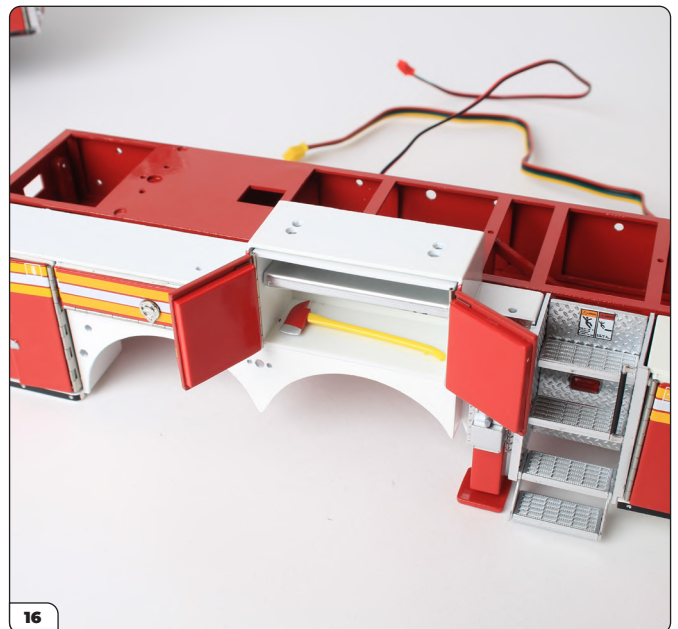

16 Place the axe in the left-hand storage compartment as shown, pushing its lugs into the holes in the bottom of the compartment.

# Stage 40: Rear Left Light Cluster, PCB and Accessories

STAGE COMPLETE

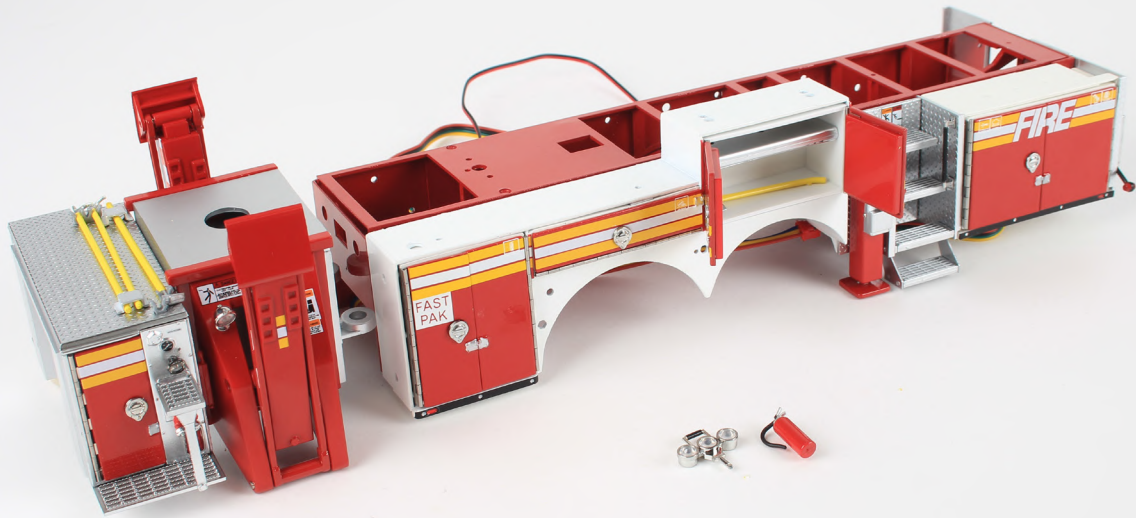

# Stage 41: Two-door Storage Compartment & Shelf

The steps in this next stage will feel quite familiar as you assemble another compartment.



## STAGE 41 PARTS LIST

Name
Compartment inner
Shelf top
Shelf bottom
Left-hand door front
Left-hand door back
Right-hand door back
Right-hand door front
Magnet
Door handle

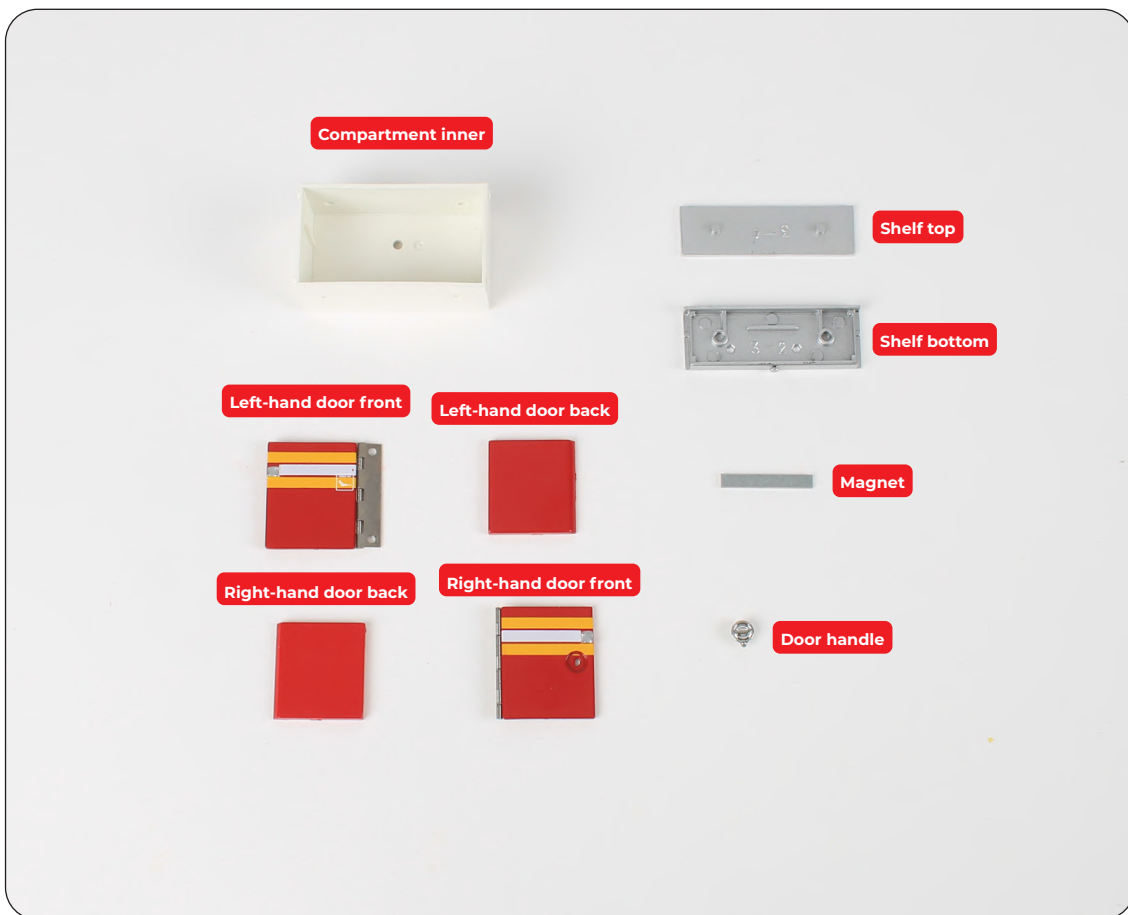

## Stage 41: Two-door Storage Compartment & Shelf



### ASSEMBLING THE SHELF

Take the shelf bottom and position the magnet between the two tabs as shown.



Align the pins in the shelf top with the corresponding holes in the shelf bottom. Push the parts together, adding a drop of glue to the pins.

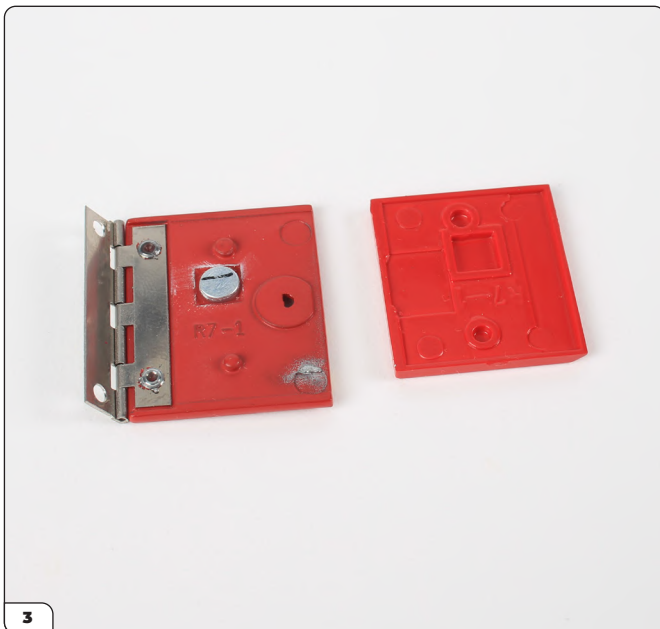

### ASSEMBLING THE RIGHT-HAND DOOR

Take the right-hand door front and right-hand door back (both parts have numbers that match up). Test fit the parts, noting that the peg and hole fixings are different sizes to ensure the correct fit. Apply a little glue to the two peg holes on the door back before fixing the two parts together.



The door is now correctly assembled.

## Stage 41: Two-door Storage Compartment & Shelf



### ASSEMBLING THE LEFT-HAND DOOR

Take the LEFT-hand door front and left-hand door back. Test fit the parts, noting that the peg and hole fixings are different sizes to ensure the correct fit. Apply a little glue to the two peg holes on the door back before fixing the two parts together.

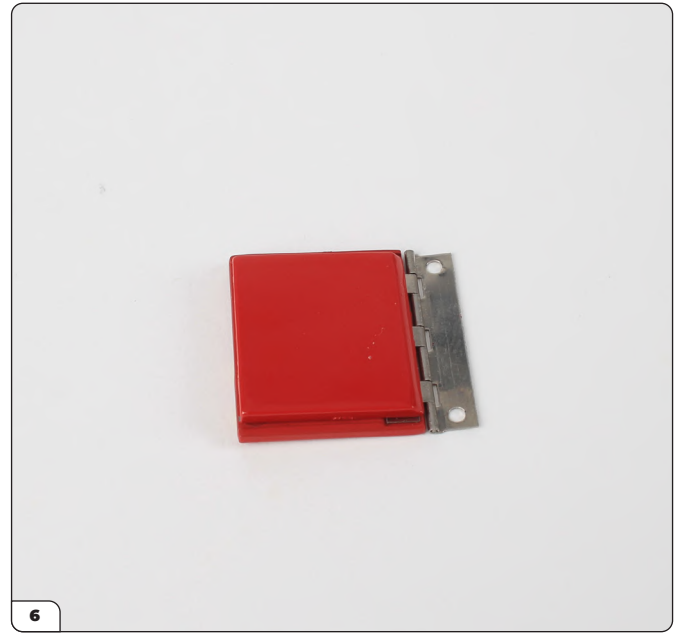

The left-hand door is now correctly assembled.



Glue the door handle in place on the front of the right-hand door. This is D-shaped fitting and the tear-drop shape points downwards.

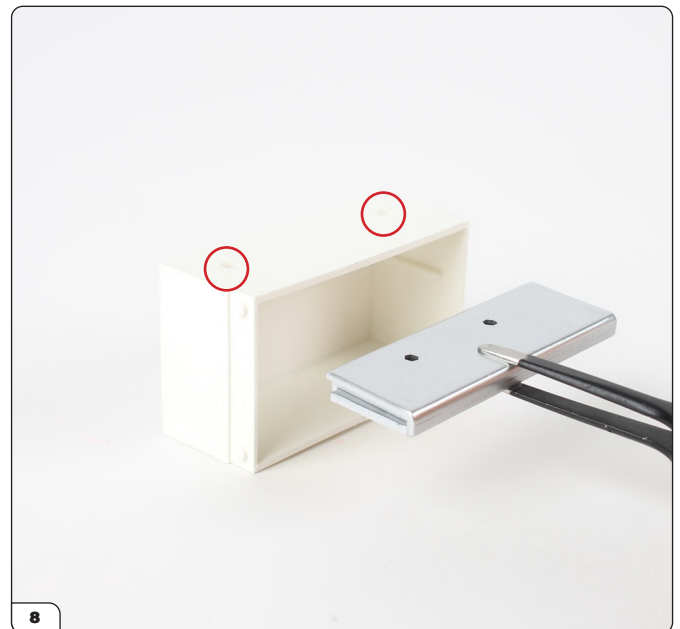

### FIXING THE SHELF AND DOORS TO THE STORAGE COMPARTMENT INNER

Take the compartment inner and check that the holes on the top are facing up (circled). Align the shelf, ensuring that the holes on the shelf are facing upwards before installing it onto the brackets on each side of the compartment inner.



## Stage 41: Two-door Storage Compartment & Shelf



Do not glue as the shelf will slide in and out to store equipment at a later stage.

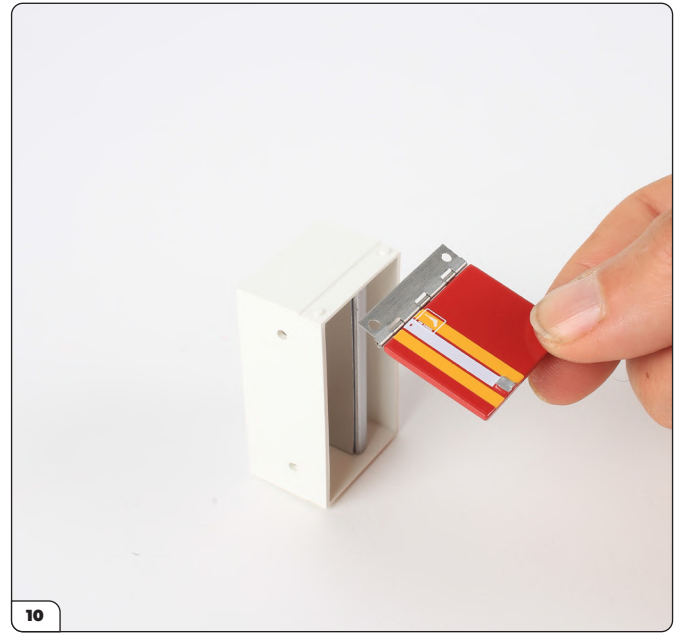

Apply a drop of glue to the recess on the left-hand side of the compartment inner. Align the peg holes with the pegs and fix the left-hand door in place.



Close the door as the glue sets to ensure the correct operation and fit.



Repeat to attach the right-hand door on the opposite side.

# Stage 41: Two-door Storage Compartment & Shelf



# Stage 42: Pull-down Storage Compartment and Rear Ladder-Bay Door

A smaller compartment is assembled in this next stage, and the right-hand rear door for the ladder bay is attached to the box frame.



## STAGE 42 PARTS LIST

Name
Compartment inner
Compartment door front
Compartment door back
Door handles x2
Right-hand rear door front
Right-hand rear door back
Type D screws x2

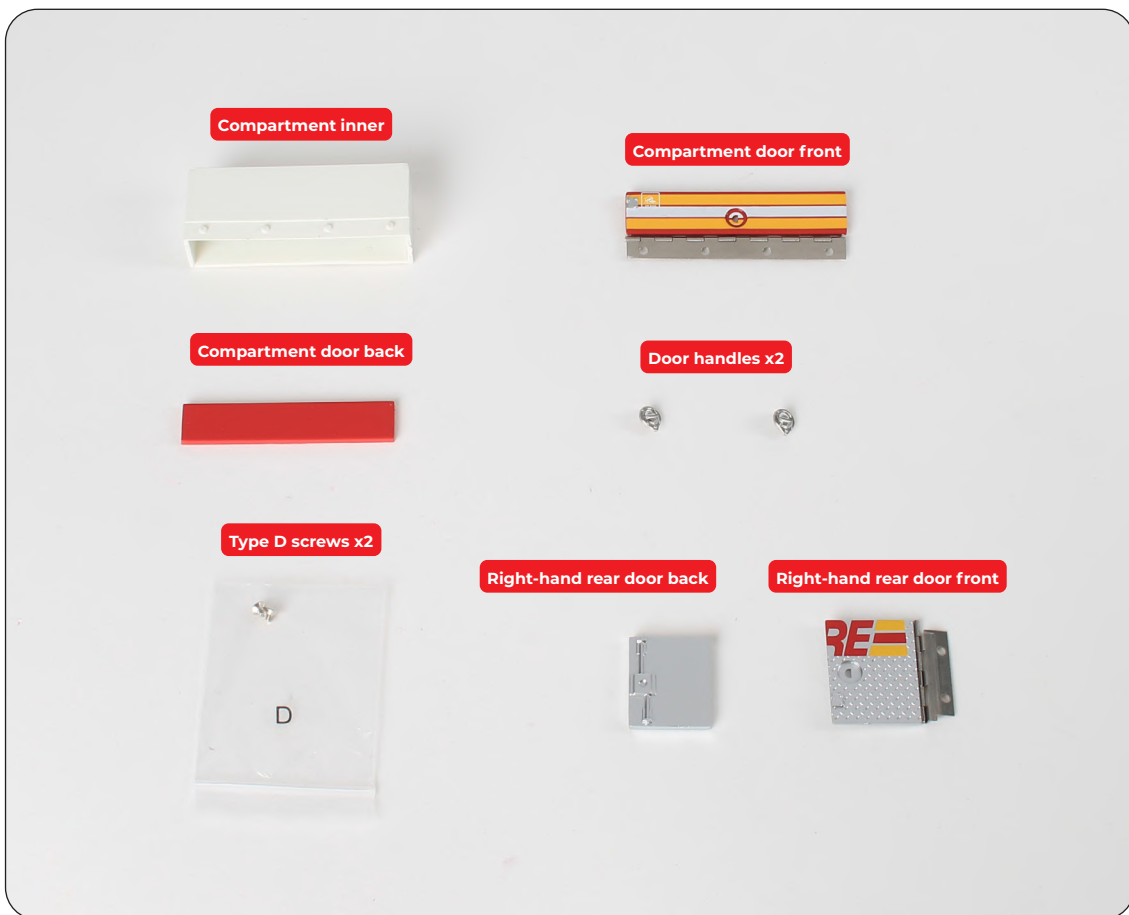

## Stage 42: Pull-down Storage Compartment and Rear Ladder-Bay Door



### ASSEMBLING THE COMPARTMENT

Take the compartment door front and back parts, checking that the square recesses for the magnet is aligned.



Apply glue, then push the parts firmly together until all four sides sit flush.



The door for this compartment pulls down, so check you have it in the correct orientation, then prepare to fit the handle. The handle is a D-shaped fitting. Apply a drop of glue before firmly pushing the handle into the fitting.



Align the hinge of the compartment door with the compartment inner, applying a little glue between the four lugs.

## Stage 42: Pull-down Storage Compartment and Rear Ladder-Bay Door



Glue the hinge over the lugs as shown, checking that the door closes correctly.



### ASSEMBLING A REAR DOOR FOR THE FIRE TRUCK MAIN BODY.

Take the right-hand rear door front and back parts, aligning them as shown. The two pairs of lugs and fitting holes are different sizes to ensure the correct fit. Note, if the hinge has detached itself, simply glue in place as shown in the picture.



Apply a little glue before firmly pressing the parts together.



Turn the door the right way up and fix the handle in place in the D-shaped hole. Prepare to fix the door to the box frame shell.



## Stage 42: Pull-down Storage Compartment and Rear Ladder-Bay Door



The door hinge fits in between the box frame and the box frame shell, just as for the left-hand side. Holding the door, gently push the hinge into the gap until the screw holes are lined up. You may need to prise the two metal frames apart to feed the hinge into the gap.



Check that the hinge is in the gap between the box frame and shell. Once in position, check that the door closes correctly.

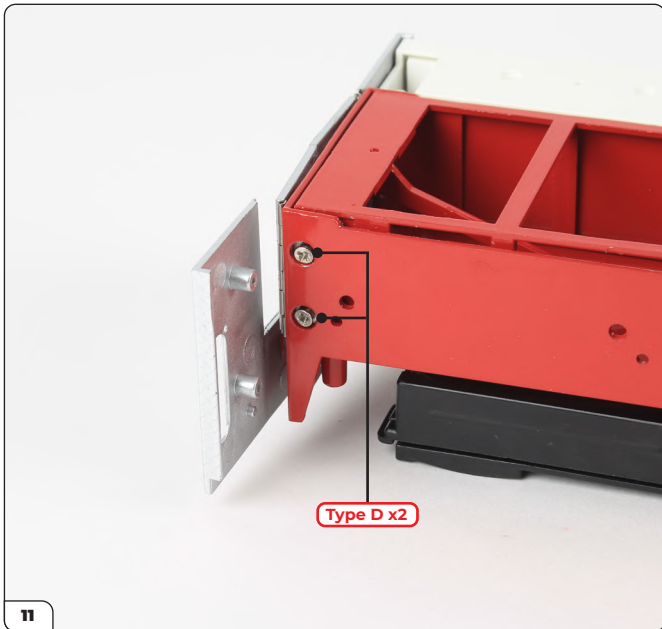

With the door in the closed position, secure it in place using 2 x TYPE D screws, driving them in from the outside of the frame.

# Stage 42: Pull-down Storage Compartment and Rear Ladder-Bay Door



# Stage 43: Two-door Tall Storage Compartment with Shelf

This is the last storage compartment in the pack to be assembled. It will house two fire-extinguishers and a double-ended pickaxe which will be supplied in a later stage.



## STAGE 43 PARTS LIST

Name
Compartment inner
Magnet
Door handle
Shelf bottom
Shelf top
Left-hand door front
Left-hand door back
Right-hand door back
Right-hand door back

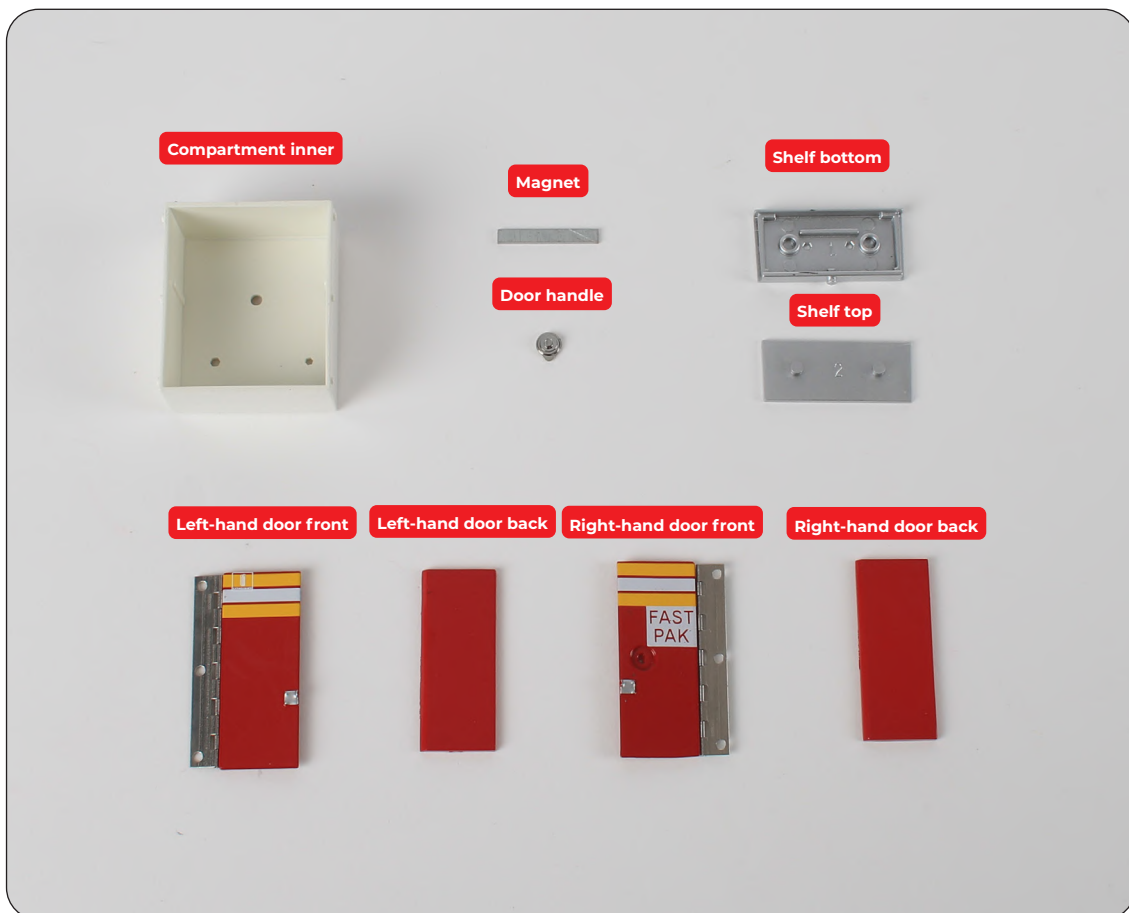

# Stage 43: Two-door Tall Storage Compartment with Shelf



## ASSEMBLING THE SHELF

Take the magnet and the shelf top. Place the magnet in the channel along the edge of the shelf as shown.



Using a little glue, take the shelf bottom and push it into the shelf top until the parts fit snugly together.



## ASSEMBLING THE DOORS

Take the left-hand door front and the left-hand door back noting the square recess for the magnet on both pieces that must be aligned.

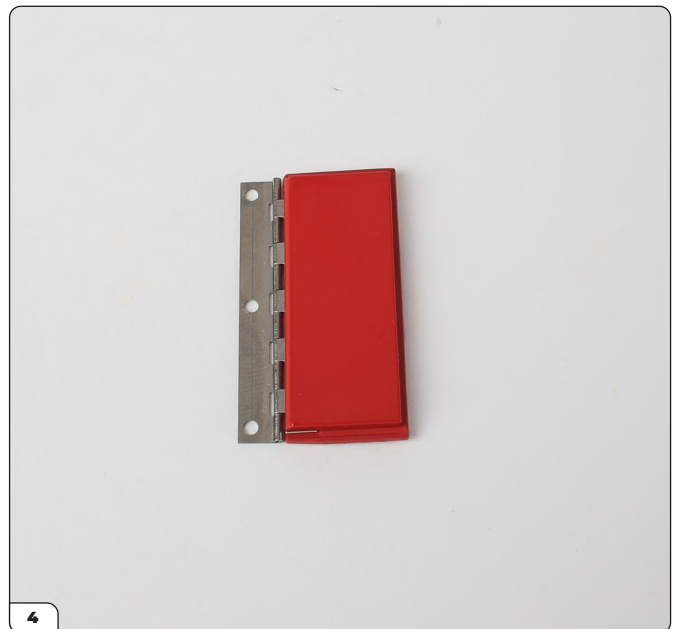

Apply a little glue to the flat surfaces before squeezing the two parts together so that the lugs firmly fit the corresponding holes and there are no gaps around the side edges.



## Stage 43: Two-door Tall Storage Compartment with Shelf



Repeat to fit the right-hand door front and back parts together. Again, check the square recesses for the magnet are correctly aligned on both parts.



Apply a little glue and check all the edges fit tightly together

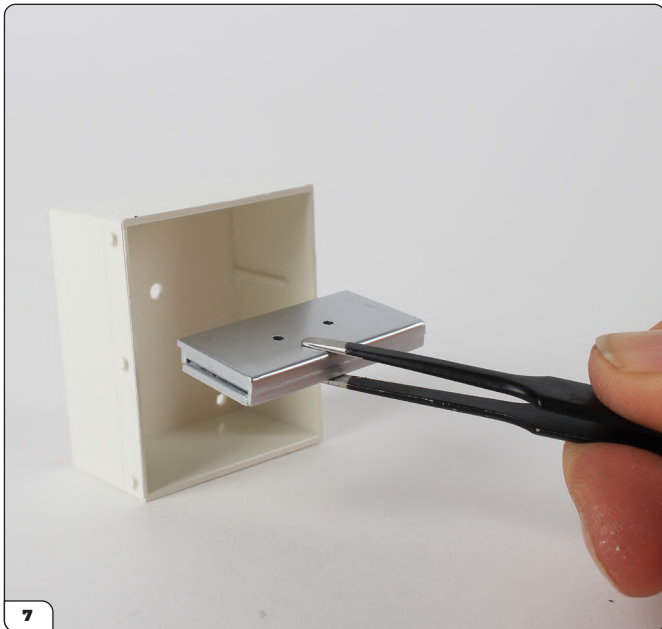

Hold the shelf with the tool-holes facing up, then push the shelf-grooves over the channels in the sides of the compartment to fit.

**Top tip:** picture 11 shows the fire extinguisher being positioned inside the compartment once built, however, you might find it easier to install the fire extinguisher before the shelf and doors.



Push the shelf into the compartment until it meets the back wall and the tiny lug on the back of the shelf is secured in place.

## Stage 43: Two-door Tall Storage Compartment with Shelf

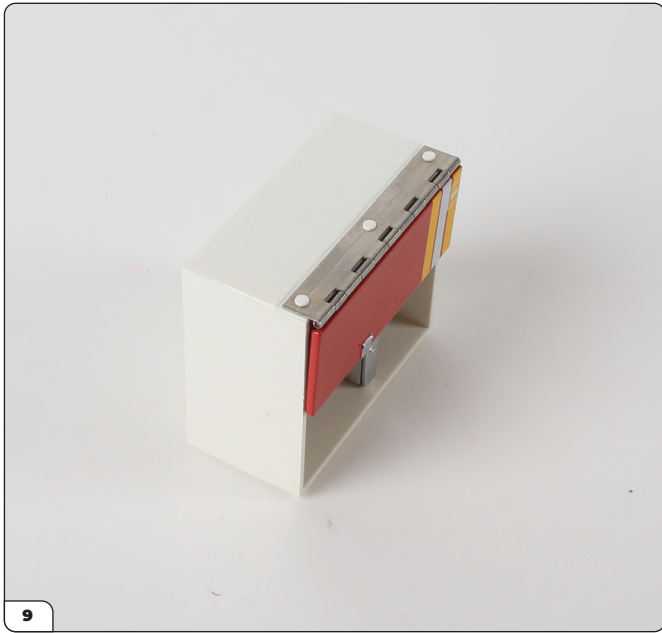

Align the three holes on the door hinge with the three lugs on the side of the compartment. Apply a little glue to the surface around the lugs. Press firmly into place, checking that the door closes in the correct position before the glue sets.

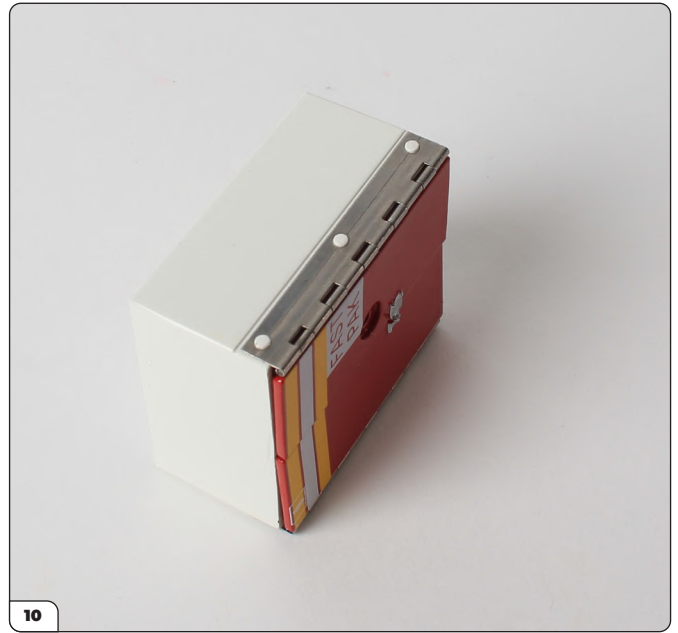

Fix the right-hand door to the compartment in a similar way, applying a little glue around the lugs.



Place the fire extinguisher from stage 40 inside the compartment, fixing its lugs into the back wall.



Your final compartment is complete and ready to install in a future stage.

# Stage 43: Two-door Tall Storage Compartment with Shelf

STAGE COMPLETE

