

1 9 6 5

# SHELBY COBRA

## 427 SEMI-COMPETITION

**1:8 SCALE**



## Pack 12 | Build Instructions

In the 1960s, Carroll Shelby's Cobras dominated racetracks worldwide, first winning races coast to coast across North America, then in 1965, winning the World Manufacturer's GT Championship, achieving the ultimate goal of defeating Ferrari. The Semi-Competitions were modified from full competition models just enough to make them street legal. Only 29 models were produced, making them one of the most sought-after American sports cars by collectors.

Your 1:8 model replicates the original 1965 Semi-Competition Cobra in intricate detail. From the detail on the dashboard dials to the writing on the wheels, every piece is precisely reproduced.

**In your twelfth and final model pack, you will assemble:**

**STAGE 91: RIGHT FENDER GRILLE  
AND JACKING PADS**

**STAGE 92: FRONT LEFT INDICATOR,  
REAR LEFT REFLECTOR AND LED**

**STAGE 93: FRONT RIGHT INDICATOR,  
REAR RIGHT REFLECTOR AND LED**

**STAGE 94: ANTI-SWAY BAR  
AND HOOD SUPPORT**

**STAGE 95: FRONT HEADLAMPS AND LEDS**

**STAGE 96: REAR VIEW MIRROR, WINDSHIELD  
WIPERS AND ROLL BAR BACK TUBE**

**STAGE 97: FUEL CAP, AIR FILTER, AND  
INSTALLING THE TRUNK, FUEL TANK, FRONT  
FLOOR AND ROLL BAR**

**STAGE 98: ENGINE COMPONENTS**

**STAGE 99: MORE ENGINE COMPONENTS**

**STAGE 100: FINAL ENGINE COMPONENTS  
AND ATTACHING THE EXHAUSTS**

# Stage 91: Right Fender Grille & Jacking Pads

In this first stage of Pack 12, you will install the front right fender grille, rear jacking pads, hood and radiator/fan assembly.



### ADVICE FROM THE EXPERTS

Don't forget, throughout this final pack, you might find it easier to drive the screws home by adding a drop of lubricant to the screw holes in the metal parts.

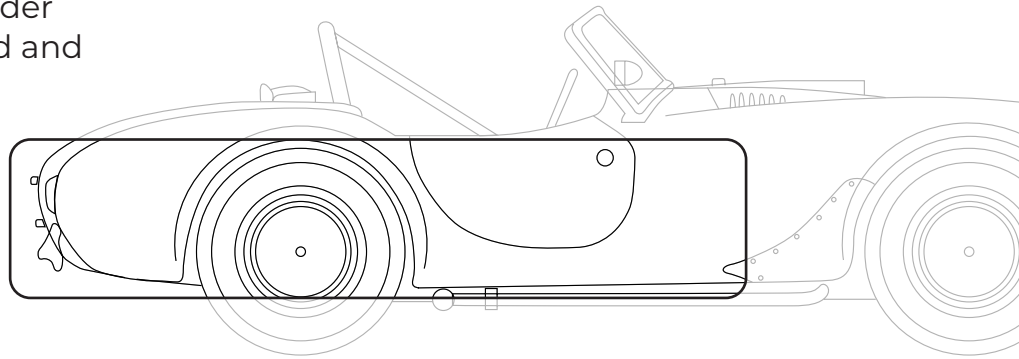

## STAGE 91 PARTS LIST

Name	Quantity
Front right fender grille	1
Rear left jacking pad	1
Rear right jacking pad	1
Screws TYPE OP02	3
Screws TYPE OD03	4



# Stage 91: Right Fender Grille & Jacking Pads

## STEP 1

### FIX THE REAR JACKING PADS IN PLACE

Align the Left Jacking Pad with the two vertical holes on the rear end of the Main Body, checking that the silver post heads are on the outer side of the body. Fix in place from the inside using a TYPE OP02 screw.

Repeat on the opposite side to fix the Rear Right Jacking Pad.



### ADVICE FROM THE EXPERTS

Do not turn the car over by holding the doors. Keep the doors closed to prevent strain on the hinges.



# Stage 91: Right Fender Grille & Jacking Pads

## STEP 2

### ATTACH THE RIGHT FENDER GRILLE

Turn the Main Body in its side so that you can access the inner right side. Position the Right Fender Grille in the opening just behind the wheel arch. Align the two holes and fix in place with a TYPE OD03 screw.



## STEP 3

### INSTALLATION OF THE HOOD AND RADIATOR/FAN ASSEMBLY

Rest the main body upside down on your work surface or polystyrene supports and introduce the hood so that the hinges rest on the hinge supports.



#### ADVICE FROM THE EXPERTS

Secure the hood with masking tape to keep it firmly in position while fitting the radiator assembly.

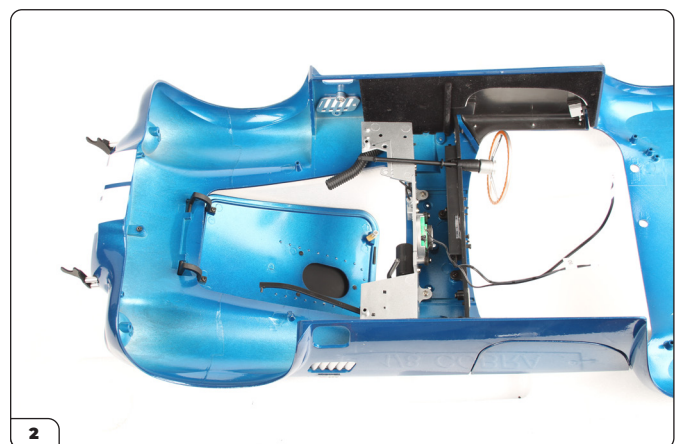
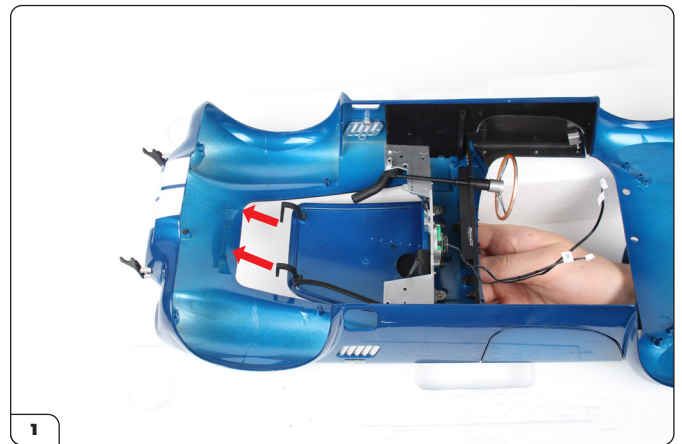



# Stage 91: Right Fender Grille & Jacking Pads

## STEP 4

### CONTINUED...

Introduce the radiator/fan assembly as shown. There are two projecting screw holes on the inside of the air inlets that align with screw holes on the inside of the main body (pictures 2 & 3). Once in position, secure in place using 2 x TYPE OD03 screws

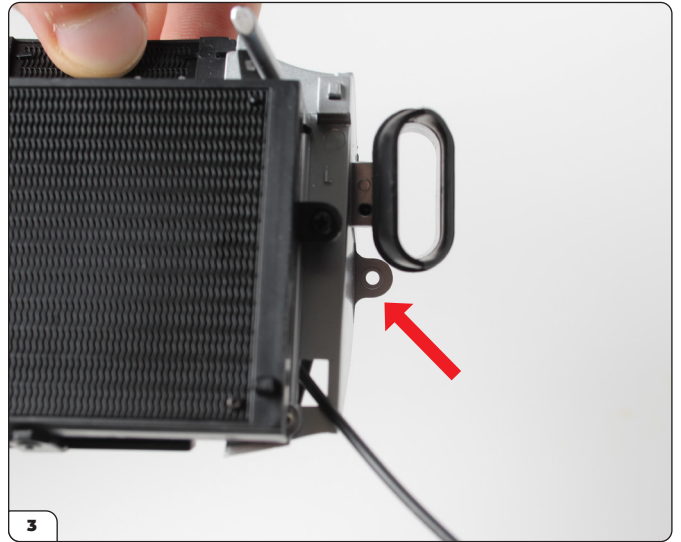
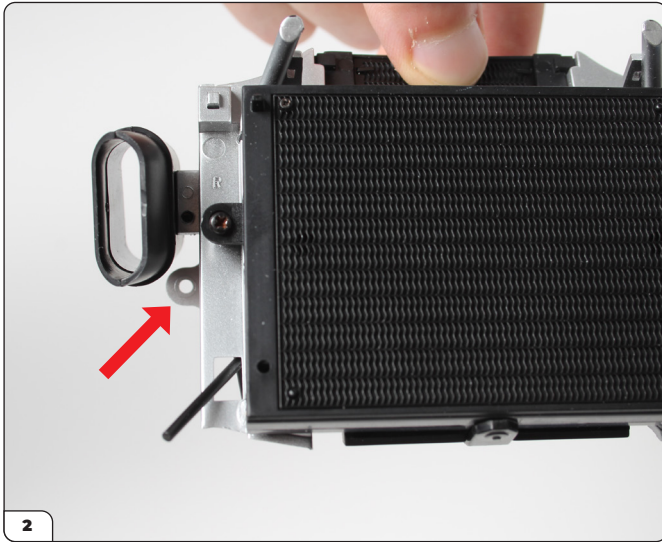
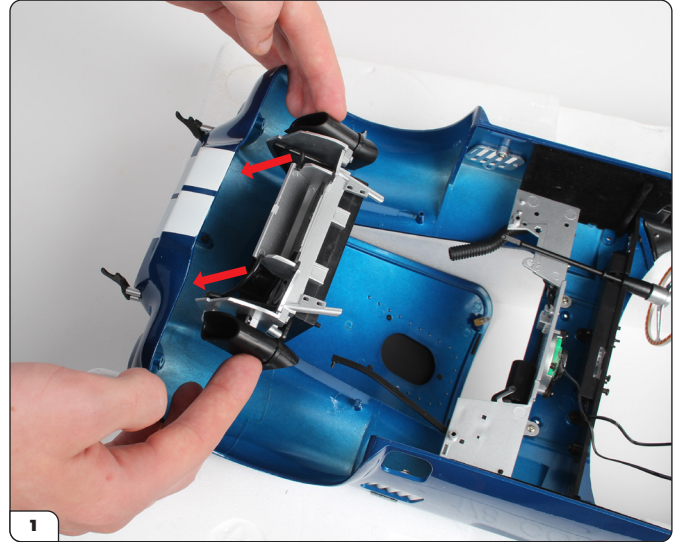

## Stage 91: Right Fender Grille & Jacking Pads

**Stage 91 complete!**



# Stage 92: Front Left Indicator, Rear Left Reflector & LED

In stage 92, you will assemble and install the front left indicator and rear left reflector.

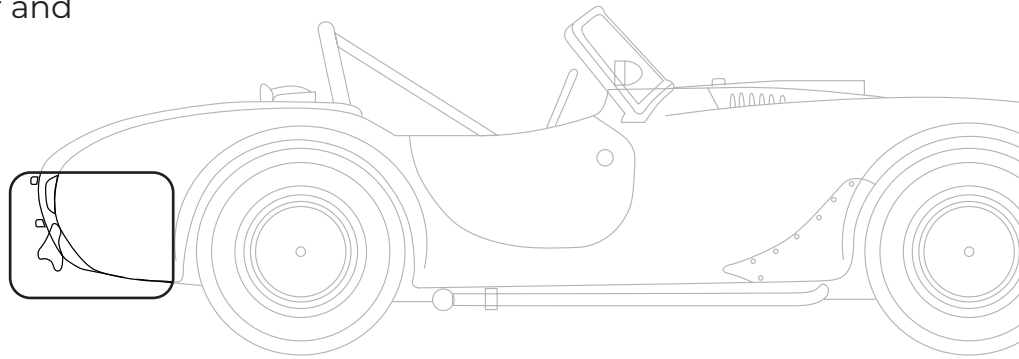

## STAGE 92 PARTS LIST

Name	Quantity
Front left indicator light lens	1
Front left indicator light bezel	1
Rear left light bezel	1
Rear left light reflector	1
Rear left light lens	1
LED with cable	1
Screws TYPE OP16	2

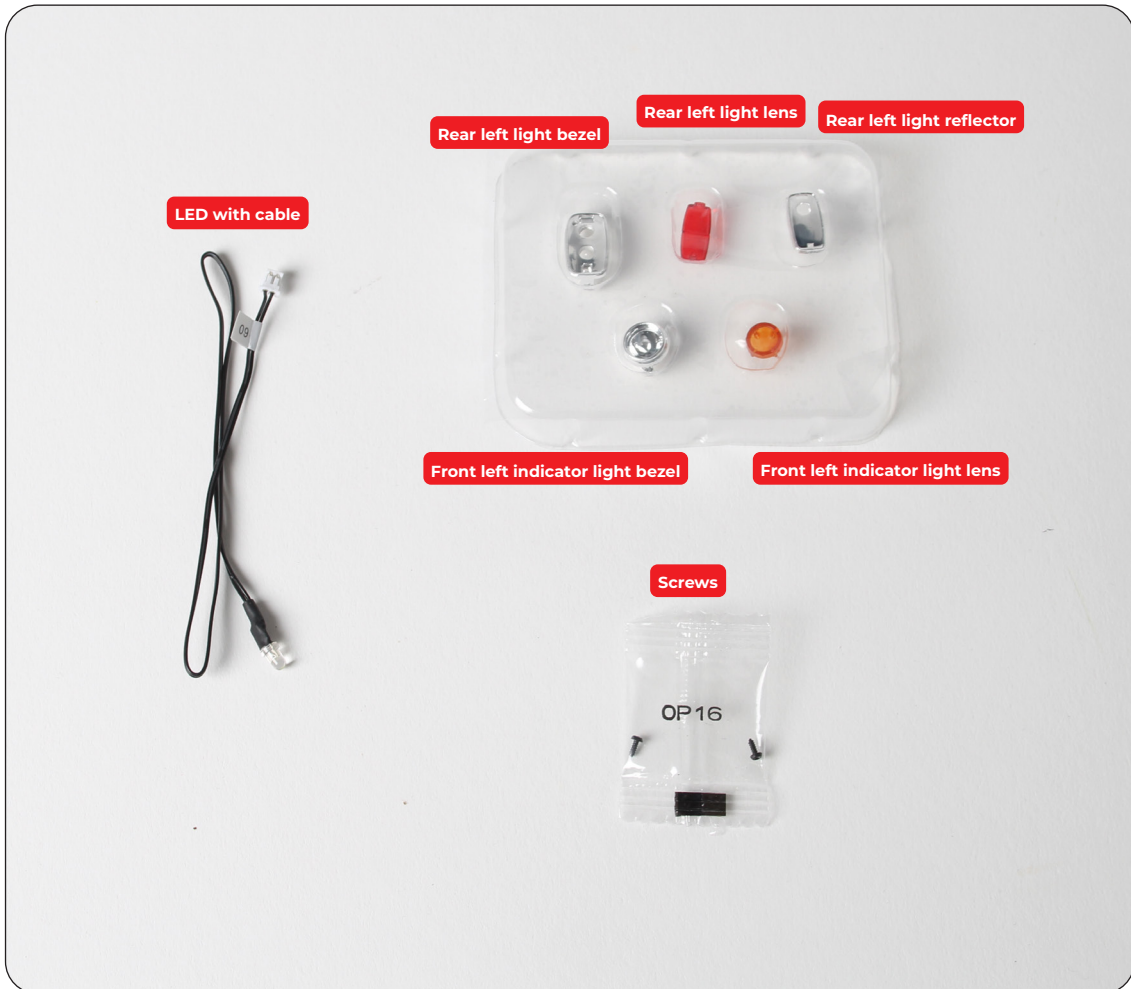



# Stage 92: Front Left Indicator, Rear Left Reflector & LED

## STEP 1

### ASSEMBLE AND INSTALL THE FRONT LEFT INDICATOR

Align the Indicator Lens with the Bezel and press the parts firmly together. Note: there is a small pin on the Lens and a small recess on the Bezel to align the Lens correctly.

Push the assembled light into position below the front headlamp recess.

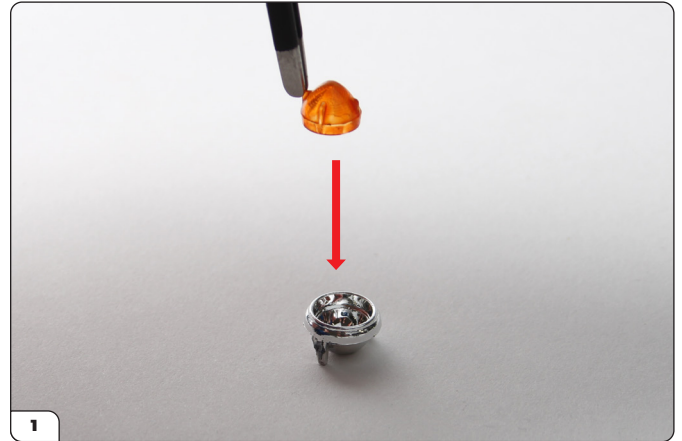



# Stage 92: Front Left Indicator, Rear Left Reflector & LED

## STEP 2

### ASSEMBLE AND INSTALL THE REAR LEFT REFLECTOR

Align the Reflector with the Bezel, push the parts together, then press the lens firmly on top.

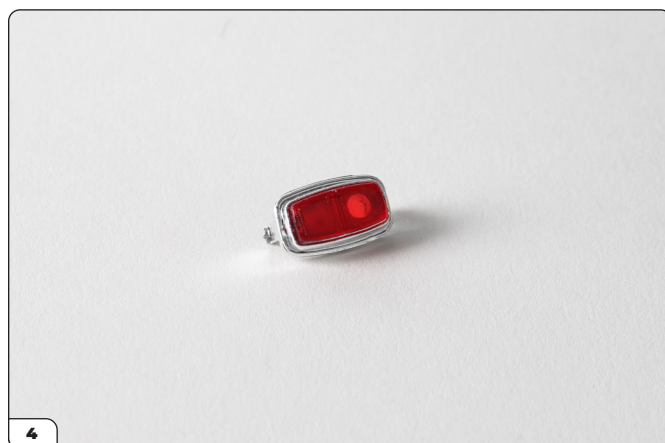
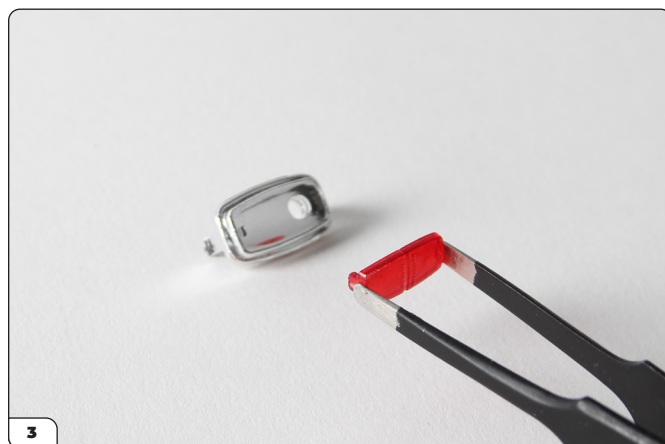
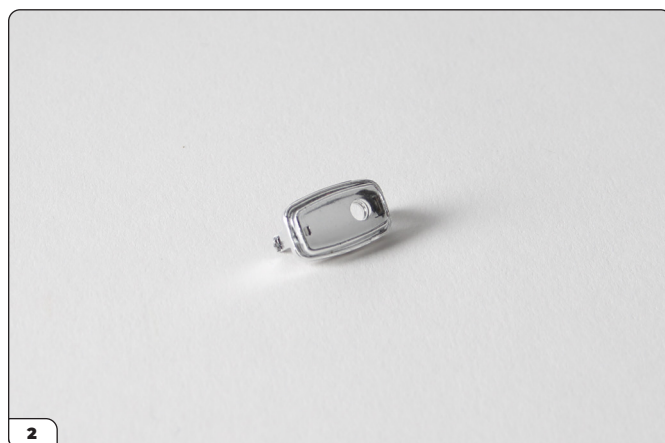

## Stage 92: Front Left Indicator, Rear Left Reflector & LED

### CONTINUED...

Press firmly in place in the recess at the rear of the main body. Turn the main body onto its side so that you can access the underside, then secure the rear reflector in place using an OP16 screw.



### STEP 3

### CONTINUED...

Take the LED on the end of the Cable and push it firmly into the back of the Rear Left Reflector you have just installed. You can secure the LED with a drop of PVA glue if it is loose.



## Stage 92: Front Left Indicator, Rear Left Reflector & LED

**Stage 92 complete!**



# Stage 93: Front Right Indicator, Rear Right Reflector & LED

In stage 93 you will assemble and install the front right indicator and rear right reflector.

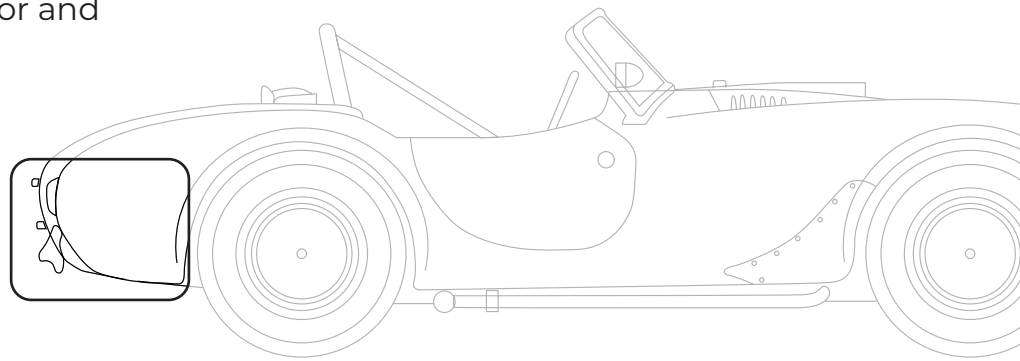

## STAGE 93 PARTS LIST

Name	Quantity
Front right indicator light lens	1
Front right indicator light bezel	1
Rear right light bezel	1
Rear right light reflector	1
Rear right light lens	1
LED with cable	1
Screws TYPE OP16	2

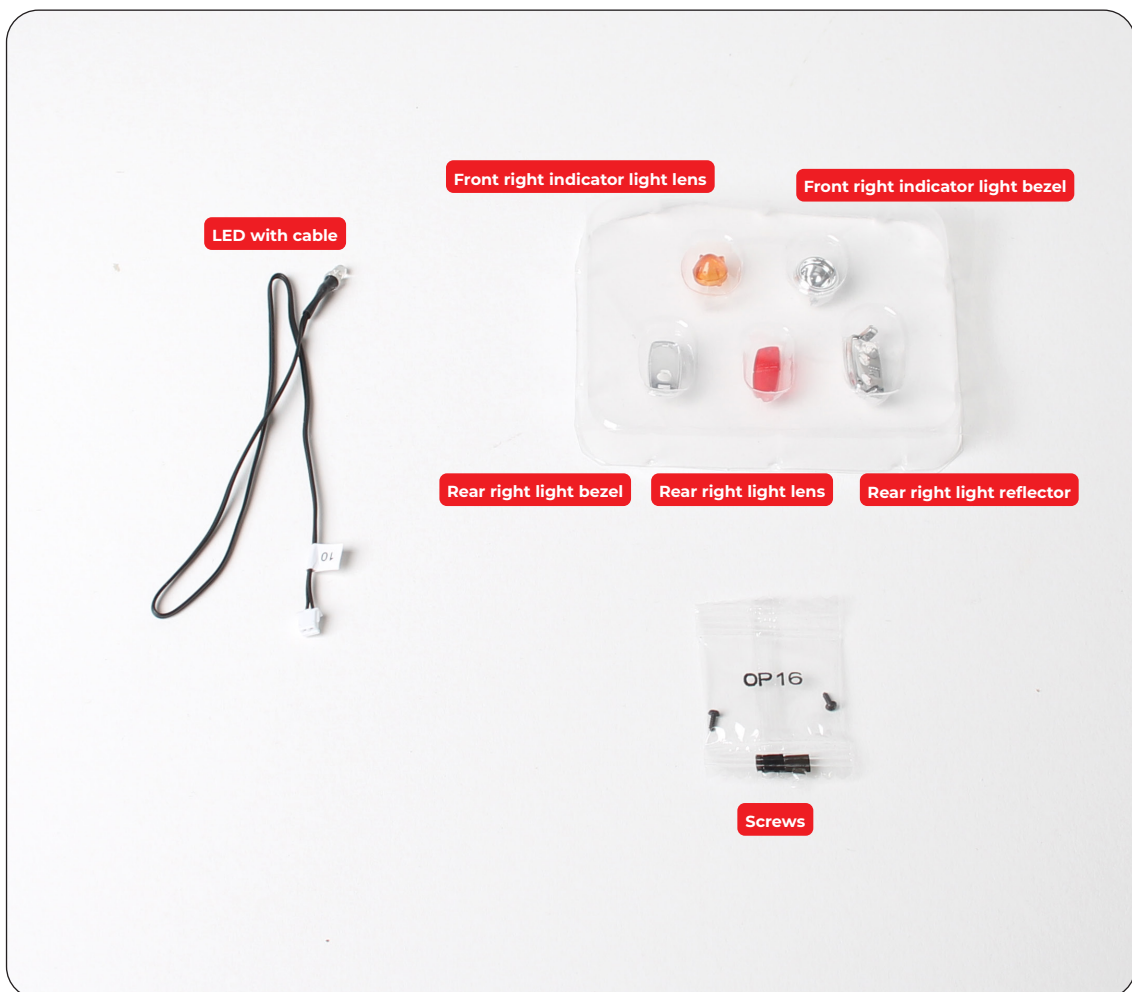



# Stage 93: Front Right Indicator, Rear Right Reflector & LED

## STEP 1

### ASSEMBLE AND INSTALL THE FRONT RIGHT INDICATOR

Align the pin on the Indicator Lens with the recess on the Bezel and press the parts firmly together.

Push the assembled light into position below the front headlamp recess.



# Stage 93: Front Right Indicator, Rear Right Reflector & LED

## STEP 2

### ASSEMBLE AND INSTALL THE REAR RIGHT REFLECTOR

Align the Reflector with the Bezel, push the parts together, then press the lens firmly on top.

Press firmly in place in the recess at the rear of the main body.



# Stage 93: Front Right Indicator, Rear Right Reflector & LED

## CONTINUED...

Turn the main body upside down so that you can access the underside, then secure the rear reflector in place using an OP16 screw.



## STEP 3

### INSTALL THE LED

Take the LED on the end of the Cable and push it firmly into the back of the Rear Right Reflector you have just installed. Secure with a drop of PVA glue if it's loose.



## Stage 93: Front Right Indicator, Rear Right Reflector & LED

**Stage 93 complete!**





# Stage 94: Anti-sway Bar & Hood Support

In stage 94, you will attach the anti-sway bar and hood support.

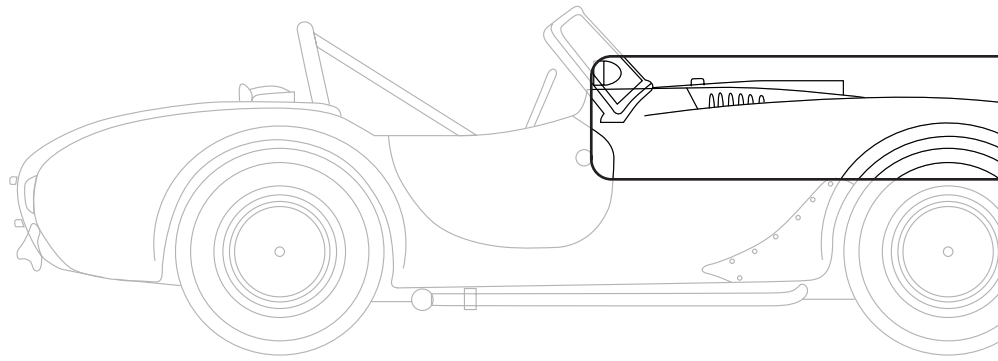

## STAGE 94 PARTS LIST

Name	Quantity
Anti-sway bar	1
Hood support	1
Hood support clip	1
Screws TYPE OD07	3

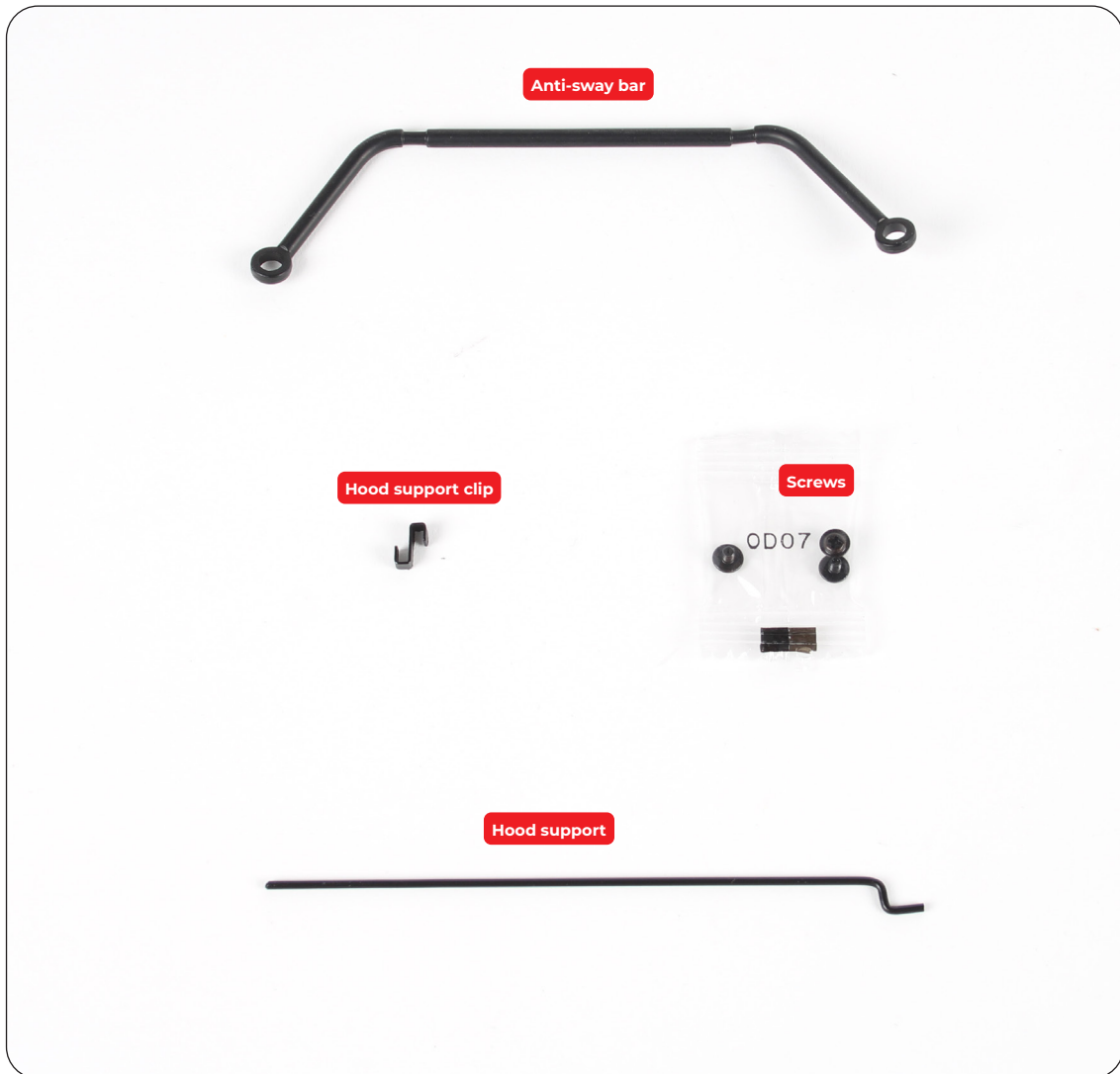

# Stage 94: Anti-sway Bar & Hood Support

## STEP 1

### ATTACH THE ANTI-SWAY BAR

Take the chassis assembly and turn it upside down on your work surface. With the front end facing you, align the holes on the ends of the Anti-sway Bar with the raised screw sockets projecting from the chassis. Secure in place with 2 x TYPE OD07 screws.

Turn the chassis the right way up.

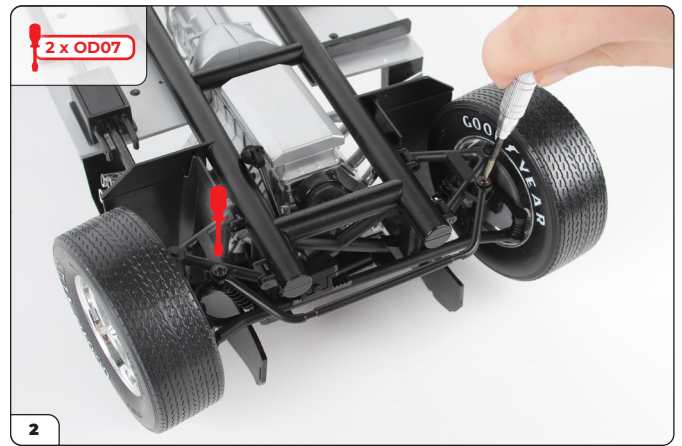
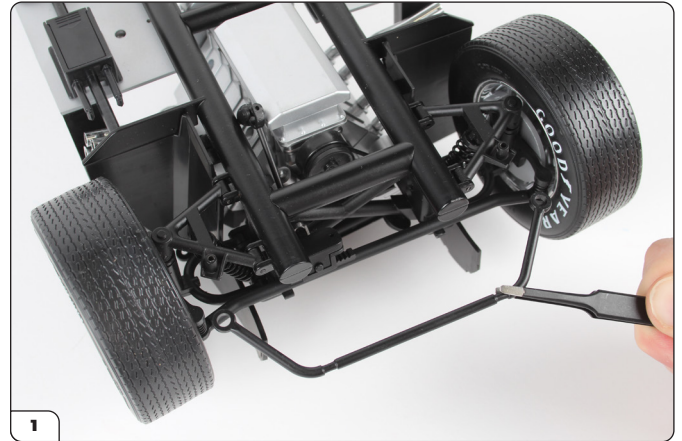

## STEP 2

### INSTALL THE HOOD SUPPORT CLIP AND SUPPORT

Press the Hood Support Clip into the notch on the Front Right Fender Liner.

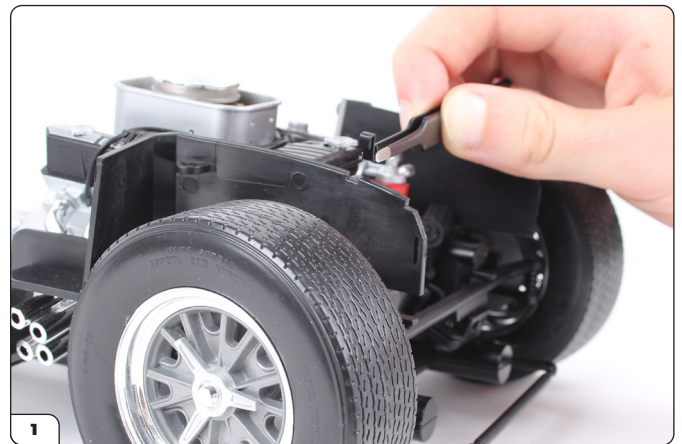

# Stage 94: Anti-sway Bar & Hood Support

## STEP 3

### CONTINUED...

Next, take the Main Body and open the Hood. There is a small hole on the right hand side that the curved end of the Hood Support fits into. Push it in place, then with the hood open, rest the opposite end of the Hood Support against the moulding in the underside of the hood to keep it in the open position. When you are happy with this operation, rest the Hood Support in the horizontal position and close and lock the Hood.



### ADVICE FROM THE EXPERTS

Tape the hood support to the inside of the fender with a small piece of masking tape to stop it falling about.

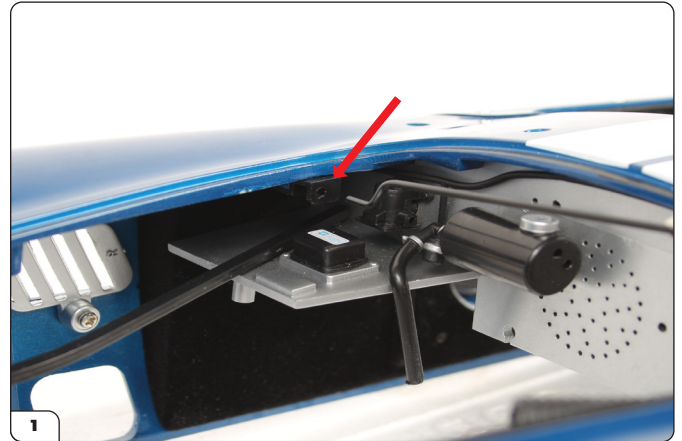

## Stage 94 complete!



## Stage 95: Front Headlamps & LEDs

In stage 95, you will assemble and install the front headlamps.

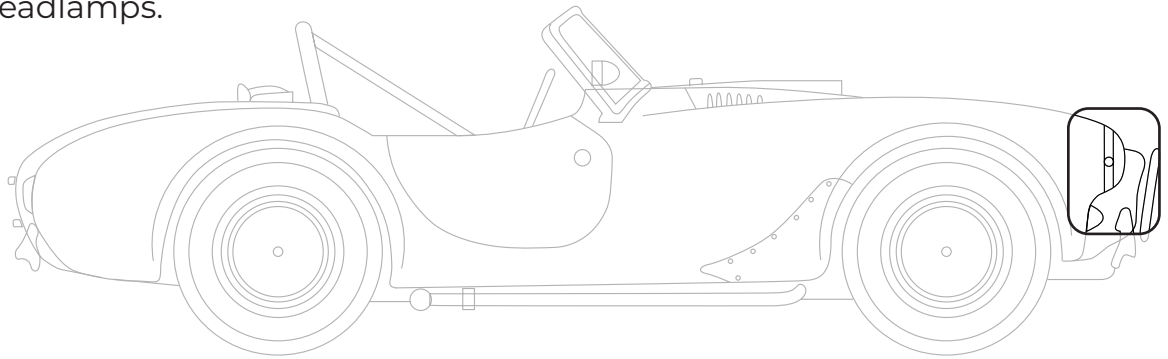

### STAGE 95 PARTS LIST

Name	Quantity
Front light left reflector	1
Front light right reflector	1
Front light left lens	1
Front light right lens	1
Left Front light LED	1
Right Front light LED	1
Screws TYPE OP08	3





# Stage 95: Front Headlamps & LEDs

## STEP 1

### ASSEMBLE THE HEADLAMPS

Push the Light Lens onto the Light Reflector, then repeat to make two sets. Note: there is a pin in the Lens and notch in the Reflector to ensure correct alignment.

Align one of the headlamps with the holes in the headlamp recess at the front end of the car. Push into place and secure from the inside using a TYPE OP08 screw.



# Stage 95: Front Headlamps & LEDs

## CONTINUED...

Push into place and secure from the inside using a TYPE OP08 screw.

Repeat on the opposite side with the remaining headlamp, securing it in place with another OP08 screw.

The LEDs will be installed in a future stage.



## Stage 95: Front Headlamps & LEDs

**Stage 95 complete!**



# Stage 96: Rear View Mirror, Windshield Wipers & Roll Bar Back Tube

In stage 96, you will attach the rear view mirror, install the windshield on the main body, and then attach the windshield wipers.



### ADVICE FROM THE EXPERTS

When working on the underside of the main body, your model is protected if you rest it on the two pieces of polystyrene packaging that came with pack 11, allowing the projecting parts to sit within the channel created.

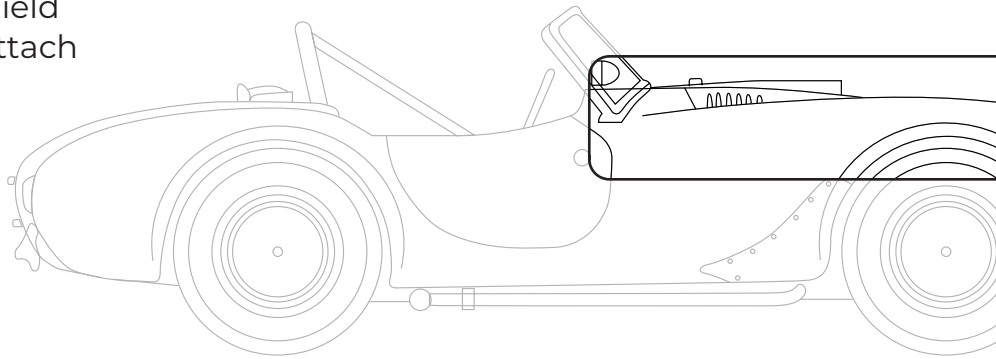

## STAGE 96 PARTS LIST

Name	Quantity
Rear view mirror	1
Rear view mirror sticker	1
Left windshield wiper	1
Right windshield wiper	1
Roll bar back tube	1
Roll bar back tube mounting plate	1
Screws TYPE OD05	4
Screws TYPE OP16	3





# Stage 96: Rear View Mirror, Windshield Wipers & Roll Bar Back Tube

## STEP 1

### ASSEMBLE AND FIX THE REAR VIEW MIRROR

Remove the backing sheet from the Rear View Mirror Sticker and fix it in place on the Rear View Mirror. Peel off the protective top sheet from the mirror.

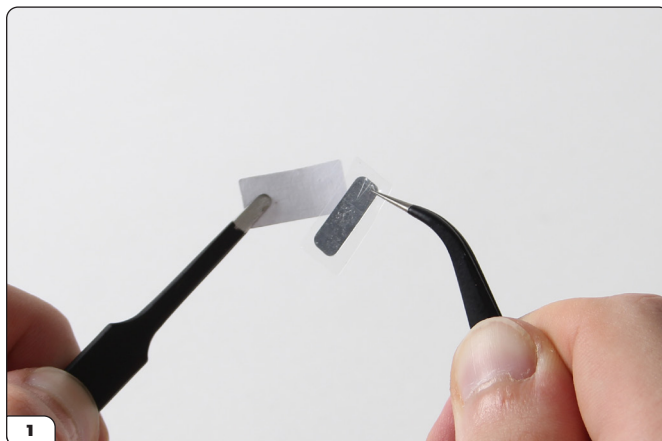

# Stage 96: Rear View Mirror, Windshield Wipers & Roll Bar Back Tube

## CONTINUED...

Fit the mirror in position in front of the steering wheel on the main body, pressing it firmly in place.

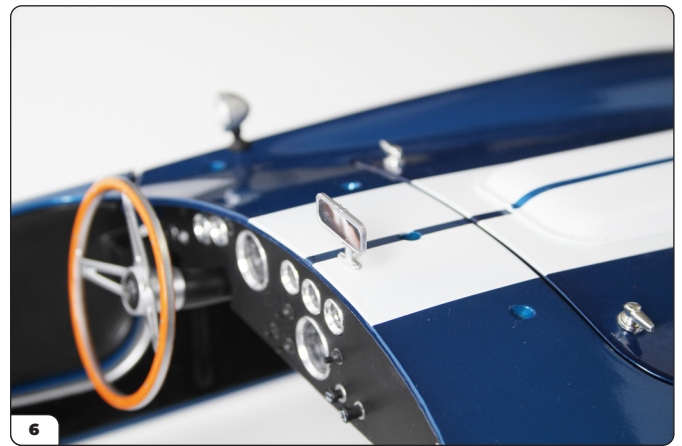
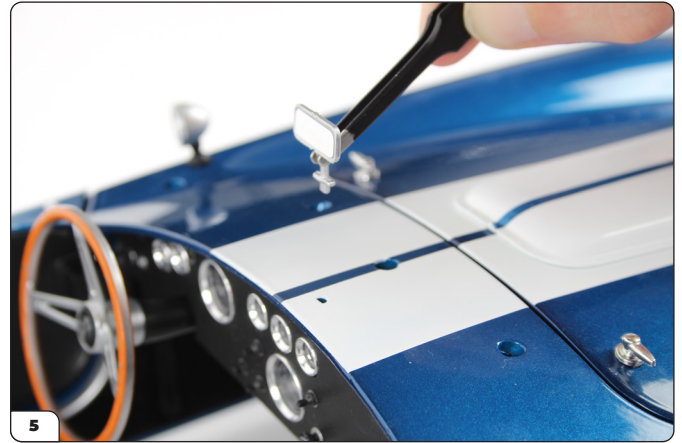

## STEP 2

### INSTALL THE WINDSHIELD

Align the three small lugs on the bottom edge of the Windshield with the corresponding holes on the main body.



# Stage 96: Rear View Mirror, Windshield Wipers & Roll Bar Back Tube

## CONTINUED...

Fix in place from the underside using 3 x TYPE OD05 screws.

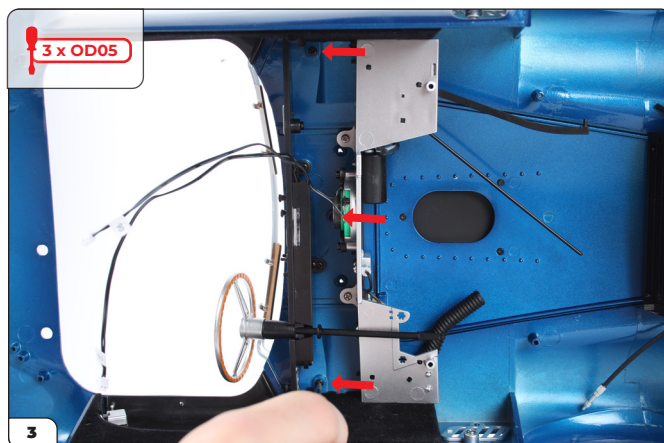

## STEP 3

### ATTACH THE WINDSHIELD WIPERS

The wipers are marked 'L' and 'R'. Take the Right wiper marked 'R' and place it in position in front of the passenger side on the windshield. Secure from the underside using a TYPE OP16 screw. Then fix the Left Windshield Wiper in the same way.

The Roll Bar Mounting Plate and Back Tube will be installed in a later stage.

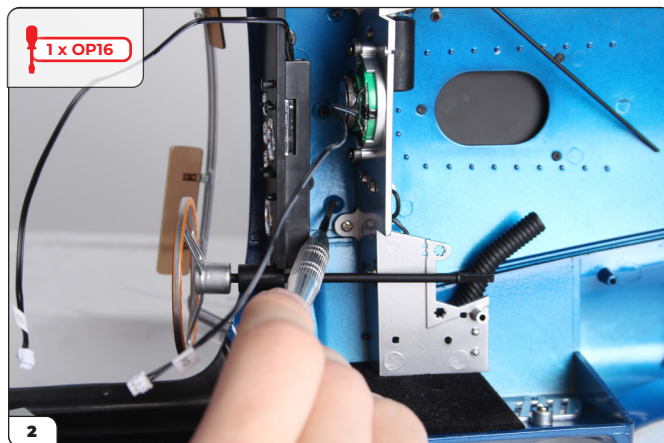
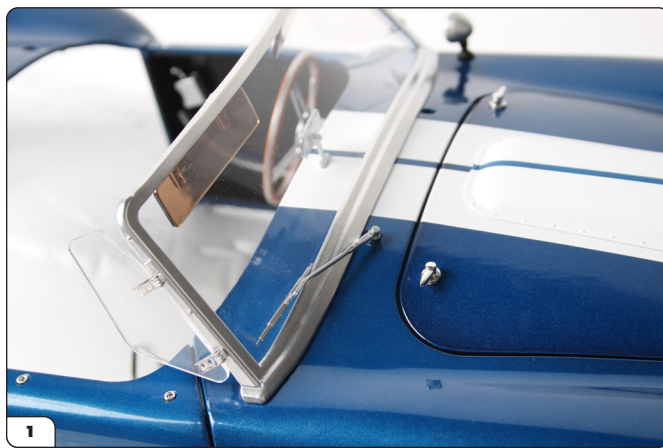



## Stage 96: Rear View Mirror, Windshield Wipers & Roll Bar Back Tube

**Stage 96 complete!**





# Stage 97: Fuel Cap, Air Filter, & Installing the Trunk, Fuel Tank, Front Floor & Roll Bar

In stage 97, you will assemble and fix the air filter and fuel cap, then install the trunk, fuel tank, front floor and drivers seat roll bar.

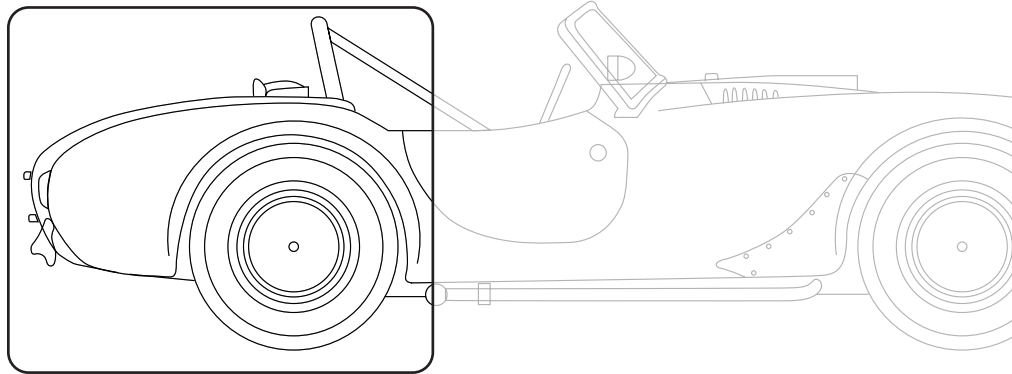

## STAGE 97 PARTS LIST

Name	Quantity
Fuel cap base	1
Fuel cap top	1
Fuel cap bottom	1
Chassis air filter housing	1
Chassis air filter grill	1
Fuel cap clasp	1
Screws TYPE OP02	2
Screws TYPE OD05	7
Screws TYPE OP08	3
Screws TYPE OD10	3

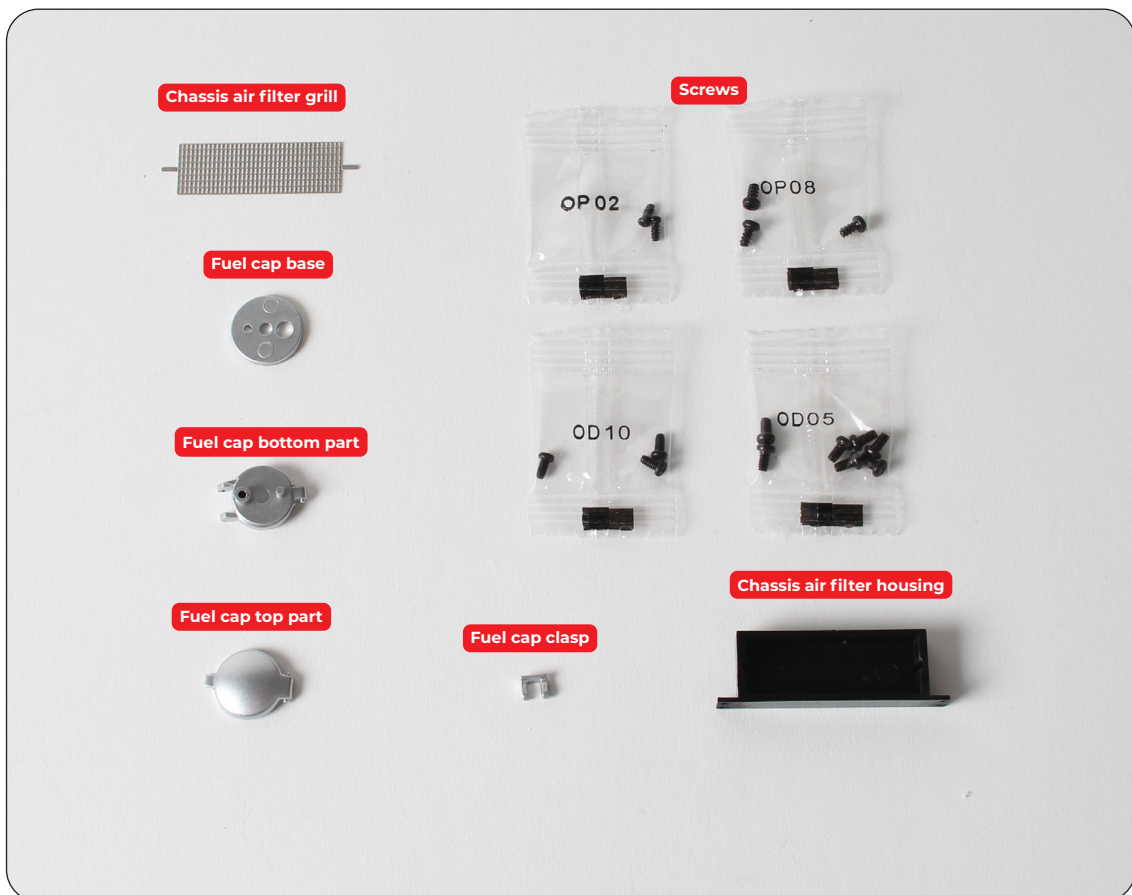

# Stage 97: Fuel Cap, Air Filter, & Installing the Trunk, Fuel Tank, Front Floor & Roll Bar

## STEP 1

### ASSEMBLE AND FIX THE AIR FILTER

Bend the tabs on the Air Filter Grille by 90°.

Press the Grille into the Air Filter Housing and bend over the tabs with an awl or similar pointed tool to fix the Grille in place. Then push the Housing into position in the Airflow Intake Panel on the underside of the chassis as shown.

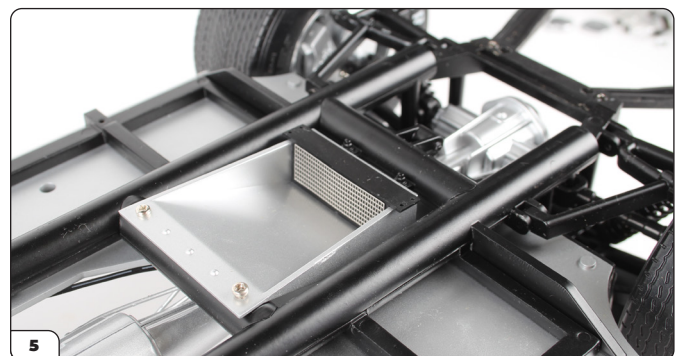
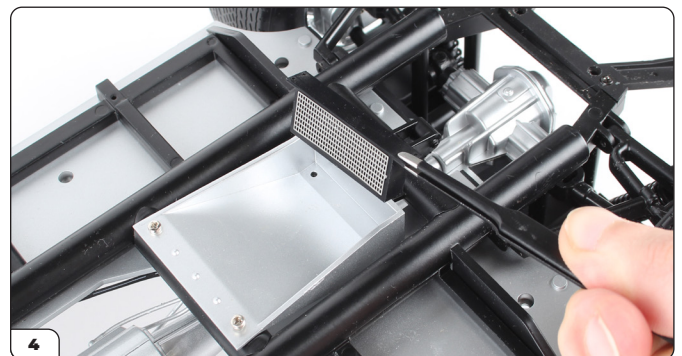
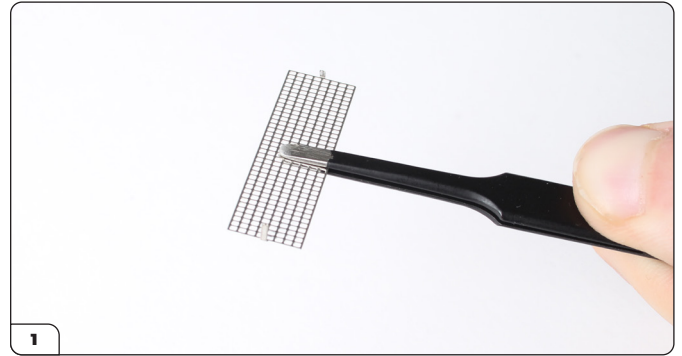

# Stage 97: Fuel Cap, Air Filter, & Installing the Trunk, Fuel Tank, Front Floor & Roll Bar

## STEP 2

### ASSEMBLE AND FIX THE FUEL CAP

Align the Fuel Cap Bottom Part with the Fuel Cap Base and press together.

Press the hinged edge of the Fuel Cap Top into the Hinge on the Bottom Part.

Push the Clasp into the hinge on the closing edge.

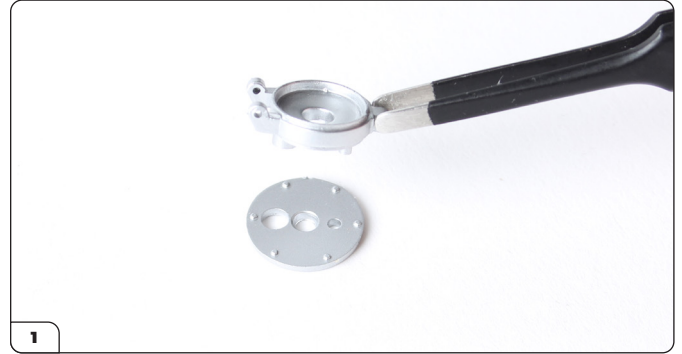

# Stage 97: Fuel Cap, Air Filter, & Installing the Trunk, Fuel Tank, Front Floor & Roll Bar

## CONTINUED...

Position the assembly in the Fuel Cap recess at the rear of the main body and secure from the underside using a TYPE OP02 screw.





# Stage 97: Fuel Cap, Air Filter, & Installing the Trunk, Fuel Tank, Front Floor & Roll Bar

## STEP 3

### INSTALL THE TRUNK LID

Support the main body so that it is raised off your work surface and introduce the Trunk Lid from below. Locate the Trunk Hinges in the recesses on the underside of the main body.

Place the Trunk Hinge Bracket from stage 70 over the hinges and secure in place using 2 x TYPE OD05 screws.

Note: make sure the hinges fit snugly by opening and closing the trunk before fixing the bracket on top.

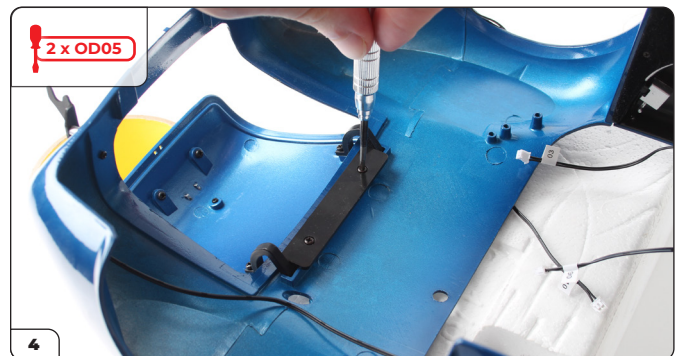
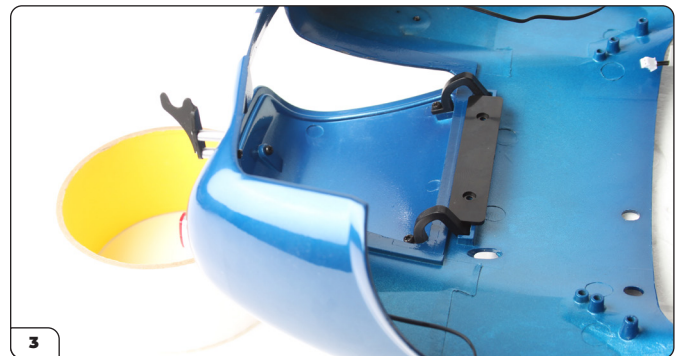

## STEP 4

### INSTALL THE FUEL TANK

Holding the Fuel Tank Assembly over the Main Body, feed the rear Indicator cables through the gaps in the sides of the Fuel Tank so that they project through to the other side.



#### ADVICE FROM THE EXPERTS

Make sure that the trunk support (fitted in stage 59) is still in place.



# Stage 97: Fuel Cap, Air Filter, & Installing the Trunk, Fuel Tank, Front Floor & Roll Bar

## CONTINUED...

Gently pull the cables completely through as you lower the Fuel Tank into position at the rear of the main body. Check that there are no cables trapped underneath before securing in place using 2 x OD05 screws.

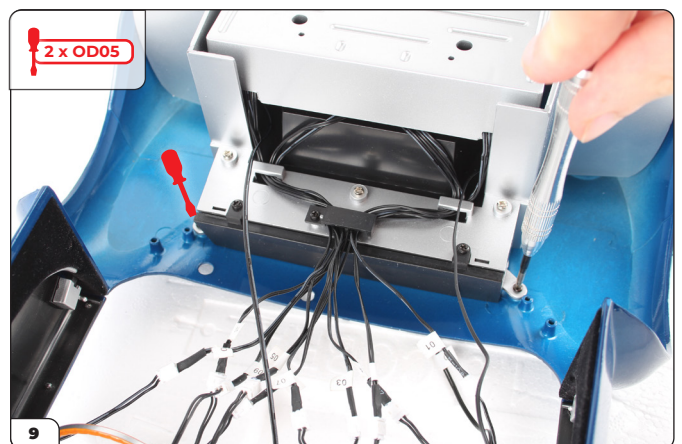
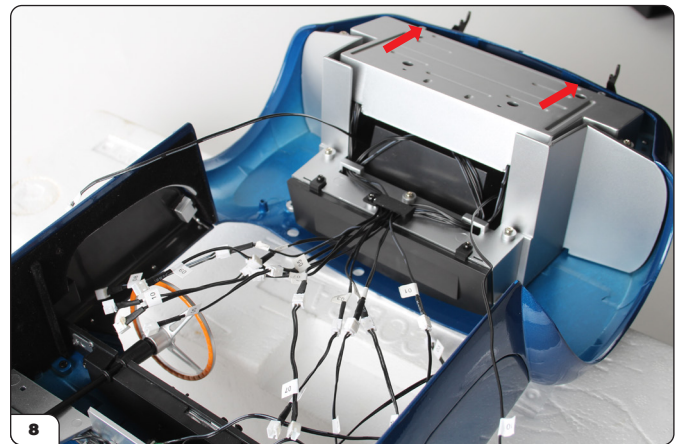
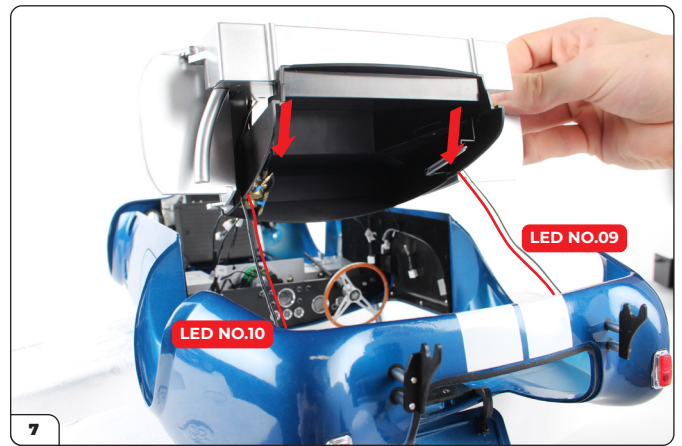
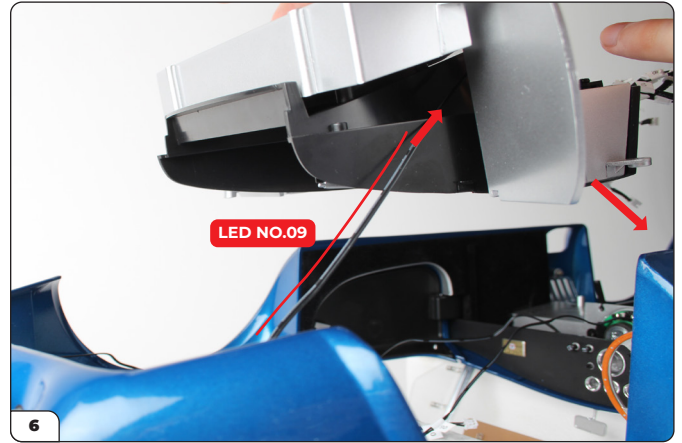



# Stage 97: Fuel Cap, Air Filter, & Installing the Trunk, Fuel Tank, Front Floor & Roll Bar

## STEP 5

### INSTALL THE FRONT FLOOR

Take the Floor Assembly and position it over the Main Body.

Make sure all the cables from the Fuel Tank are lifted out of the way before turning it upside down and lowering it into position in front of the Fuel Tank. Also check that the cables from the dash are fed through the notch in the firewall.

Press firmly in place and secure using 2 x TYPE OD05 screws.

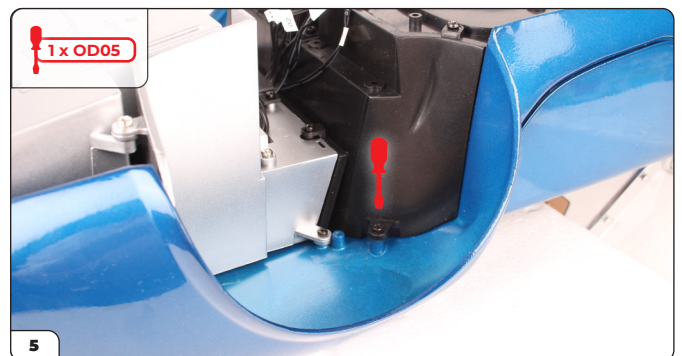
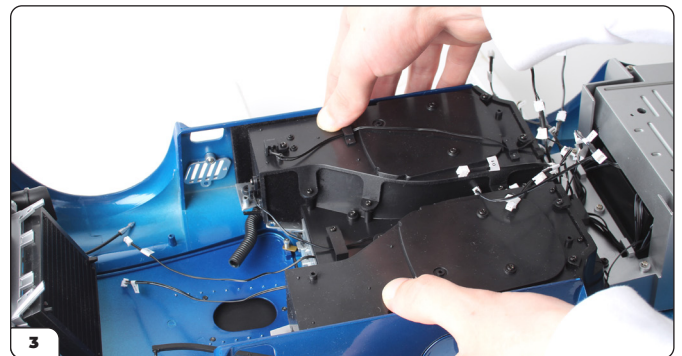
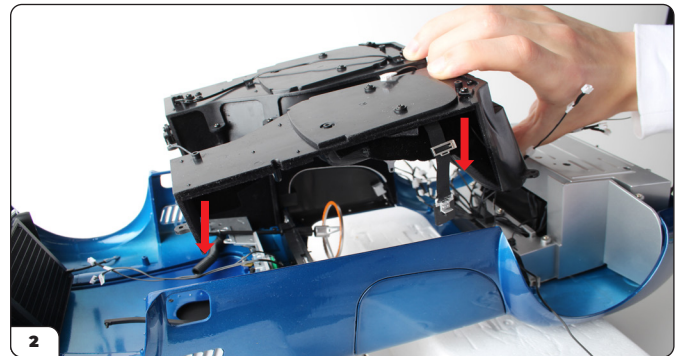
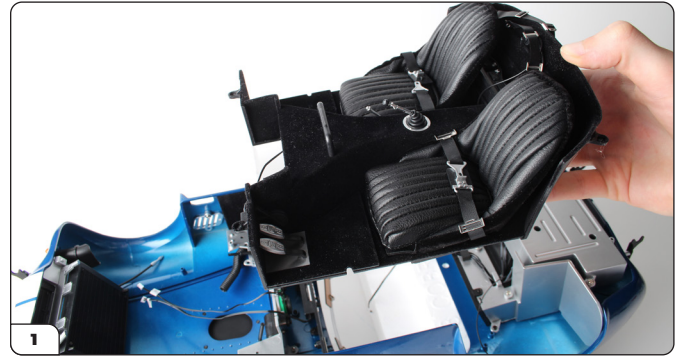

# Stage 97: Fuel Cap, Air Filter, & Installing the Trunk, Fuel Tank, Front Floor & Roll Bar

## STEP 6

### INSTALL THE ROLL BAR

Turn the Main Body the right way up and open the trunk. Fit the Roll Bar Back Tube Mounting Plate from stage 96 into the shaped-recess in the trunk.

From the outside, feed the Roll Bar Back Tube from Stage 96 through the hole next to the trunk hinge until it sits snugly in the Mounting Plate.

Lower the Roll Bar assembly from stage 65 into the remaining two holes behind the drivers seat.





# Stage 97: Fuel Cap, Air Filter, & Installing the Trunk, Fuel Tank, Front Floor & Roll Bar

## CONTINUED...

Turn the Main Body upside down and secure the Roll Bar from underneath using 2 x OD10 screws.

Continue to secure the chassis in place behind the front wheel arches on both sides using 2 x OP08 screws.

Turn your model the right way up and press the Roll Bar back Tube firmly into the joint on the Roll Bar.

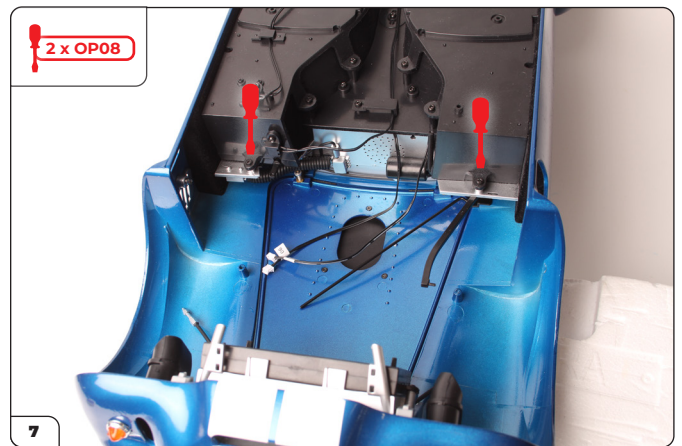
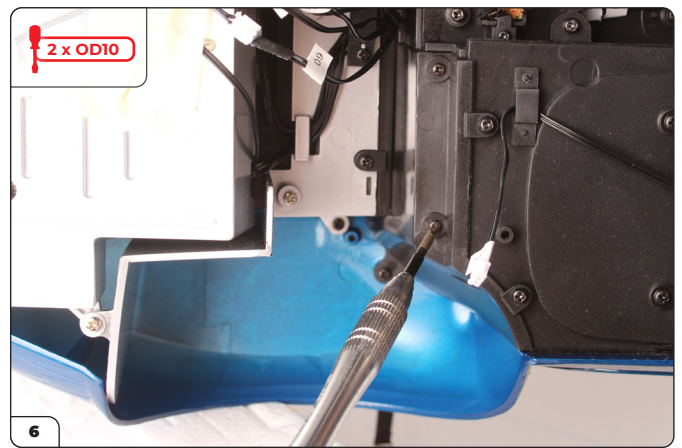

## Stage 97: Fuel Cap, Air Filter, & Installing the Trunk, Fuel Tank, Front Floor & Roll Bar

**Stage 97 complete!**



# Stage 98: Engine Components

In stage 98, you will start to add components to the engine.

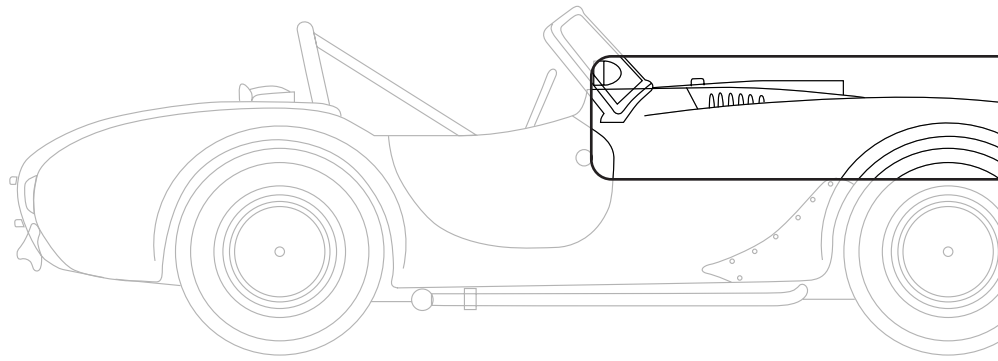

## STAGE 98 PARTS LIST

Name	Quantity
Canister set	1
Small pipe 1	1
Small pipe 2	1
Small pipe 3	1
Bottom radiator large pipe	1
Set of pipe connectors (x4)	1



# Stage 98: Engine Components

## STEP 1

### ASSEMBLE THE PIPES

Start by cutting the connectors off the sprues from the Set of 4 (you have 1 spare).

Press the thinner end of the three connectors onto each of the three pipes.

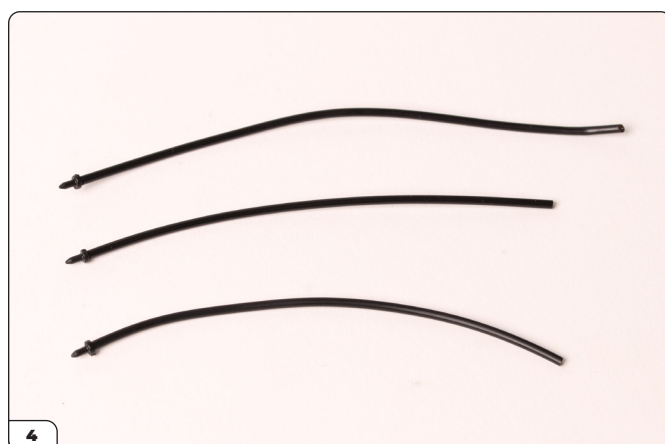



# Stage 98: Engine Components

## CONTINUED...

Push the opposite end of each pipe onto the Canister Set. Note: the longest pipe attaches to Canister marked '2'.

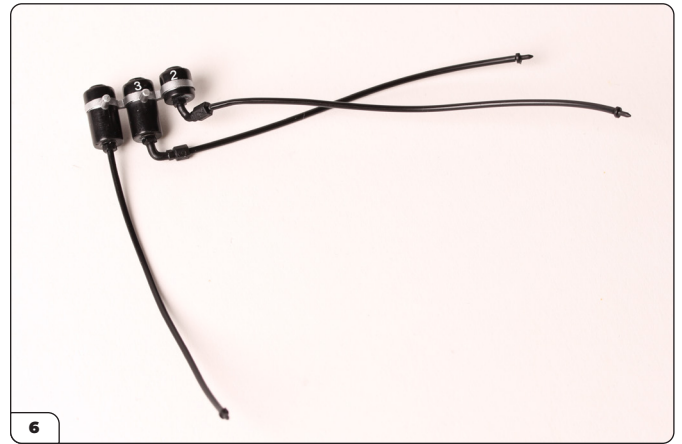
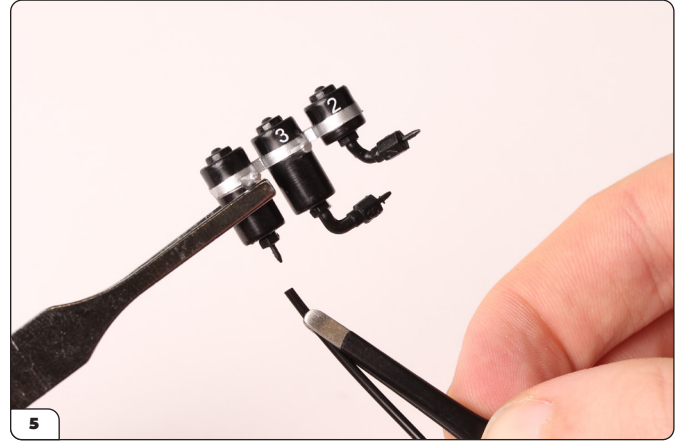

## STEP 2

### CONNECT THE CABLES

Place the main body upside down on your work surface, supported on the sides to protect the Windshield. Feed cables 03, 05 and 06 under the bracket where shown, and connect pairs of cables 02, 03, 04, 05, 06, 09 & 10.

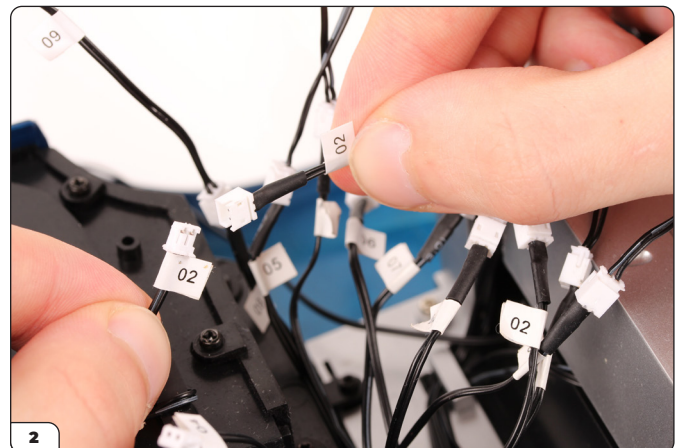
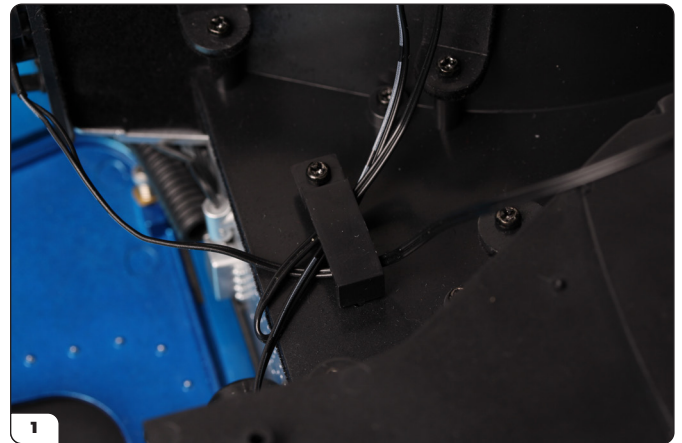

# Stage 98: Engine Components

CONTINUED...

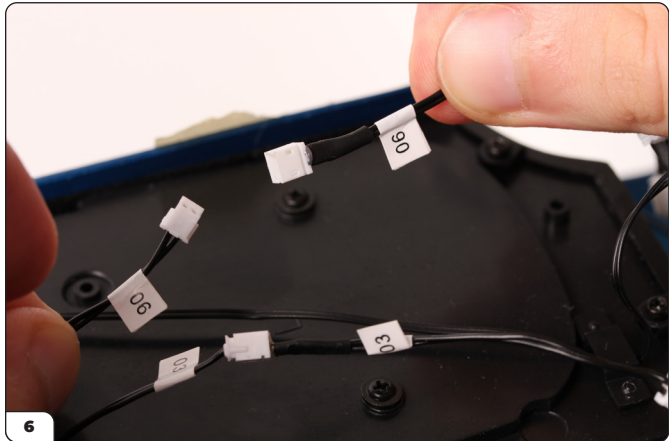
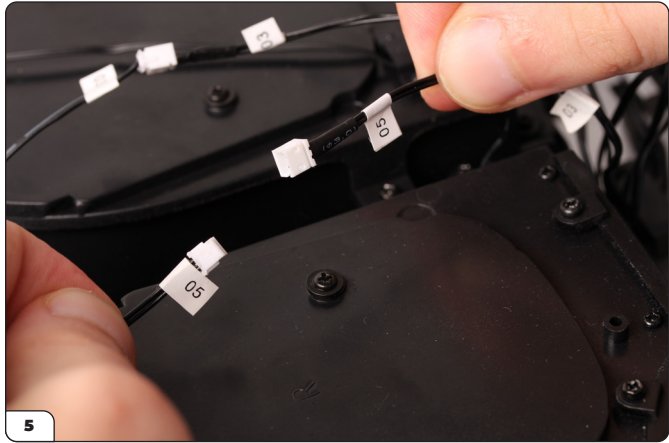
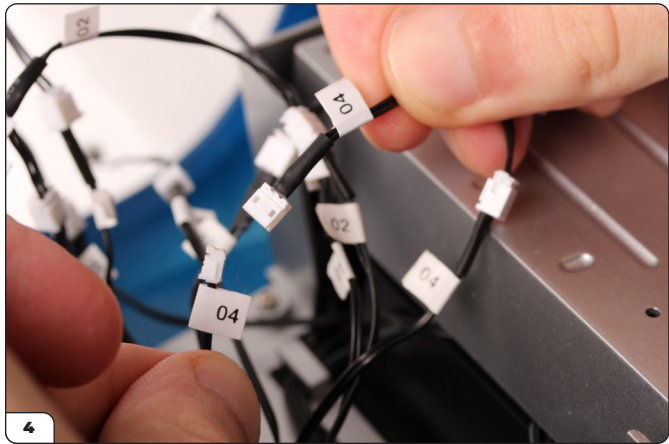
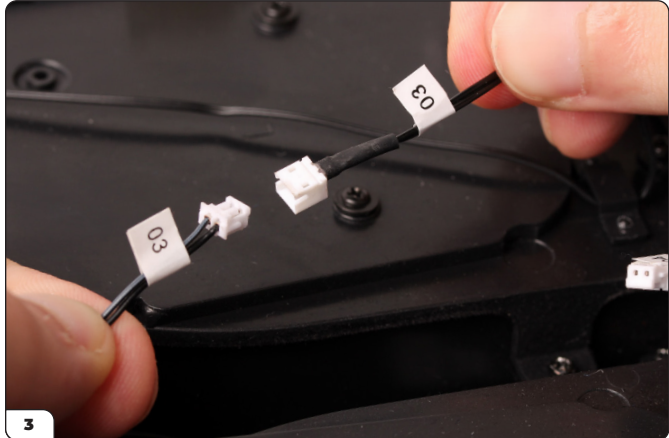

## Stage 98: Engine Components

### CONTINUED...

Tuck all the joined cables into the central section of the floor.

The Bottom Radiator Large Pipe and Canister Set will be installed in a future stage.

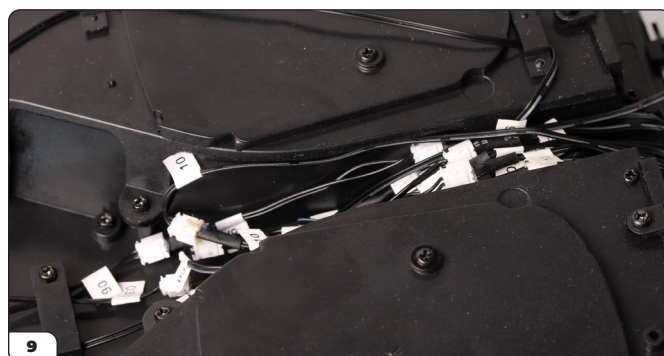
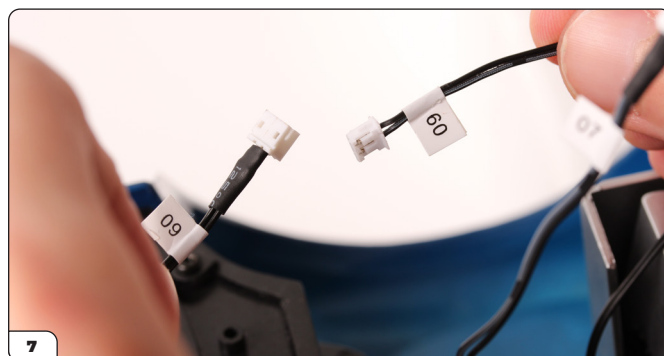

# Stage 98: Engine Components

**Stage 98 complete!**





# Stage 99: More Engine Components

In stage 99, you will add more components to the engine.

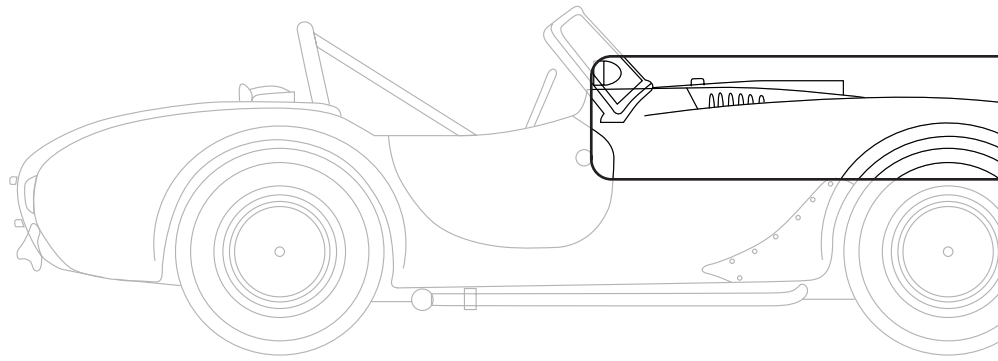

## STAGE 99 PARTS LIST

Name	Quantity
Small pipe 99a	1
Pipe 99c	1
Fuel line 99b	1
Pipe 99e	1
Fuel pipe 99f	1
Steering shaft top cover plate 99d	1
Front lateral cage left bar 99g	1
Screws TYPE OD05	5
Screws TYPE OP08	5
Screws TYPE OP03	7
Screws TYPE OD11	2

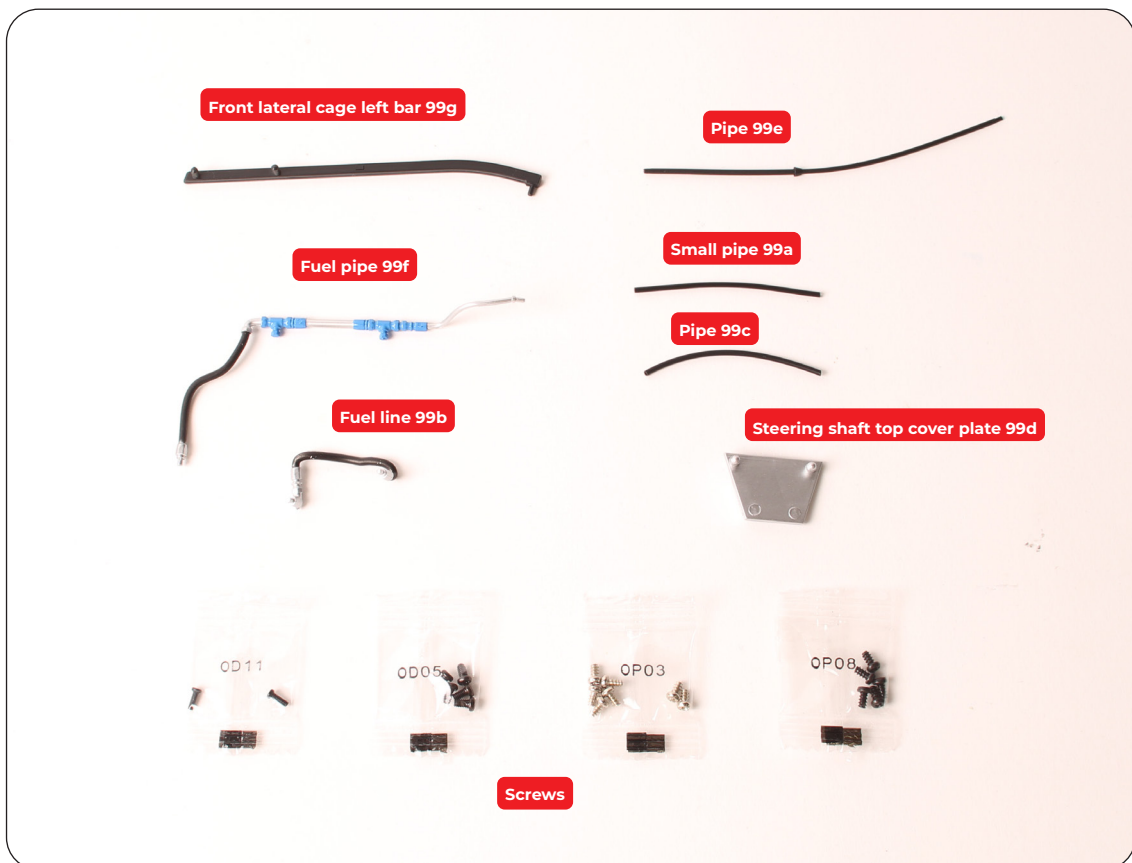

# Stage 99: More Engine Components

## STEP 1

### REMOVE THE WHEELS

Remove the four wheels from the chassis by pulling off the magnetic spinner and then unscrewing the screw. Keep the spinners, screws and wheels safely to one side for re-installation. Note that the front and back wheels are different.



## STEP 2

### INSTALL THE ENGINE COMPONENTS

Take the Fuel Line (99b) and position it inside the engine section as shown. Press both ends into their corresponding holes to secure in place.

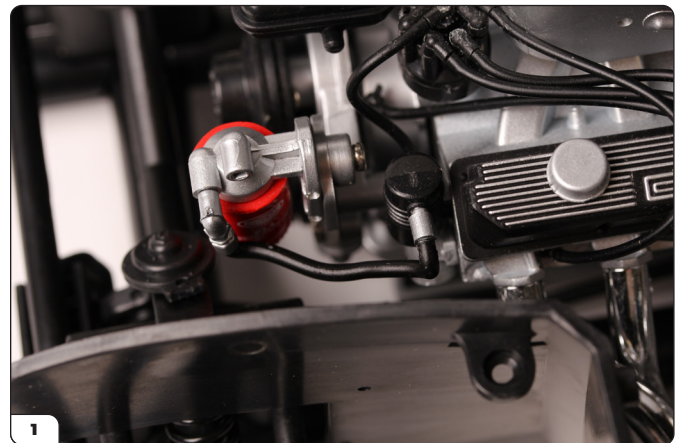

Take Pipe 99c and place one end in the hole on the Flywheel Cover as shown. The top end of pipe 99c is left unconnected for now.

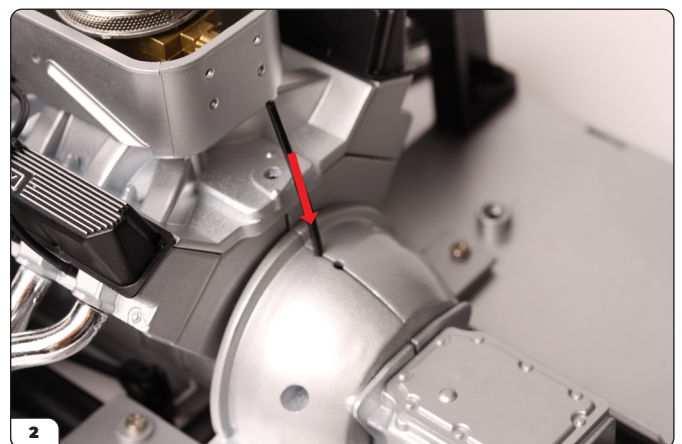

# Stage 99: More Engine Components

Take cable No. 07 from Stage 95 and thread it through the engine section, from front to back as shown. Leave equal lengths of cable projecting from both sides of the engine. Repeat on the opposite side with cable No. 08.

Note: the LED goes to the front of the car and the connector to the rear.

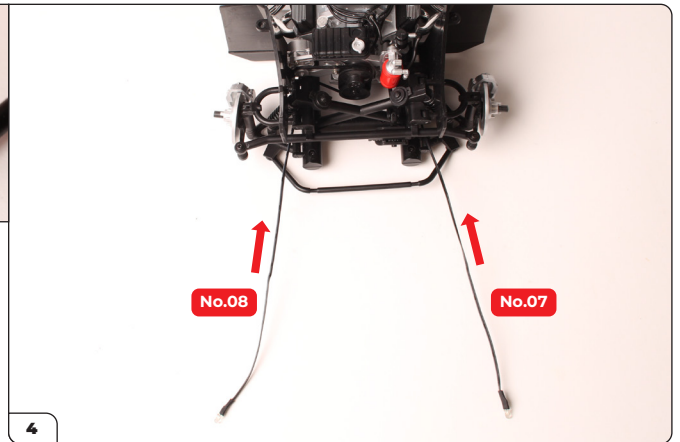
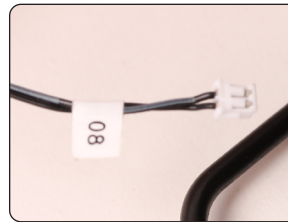
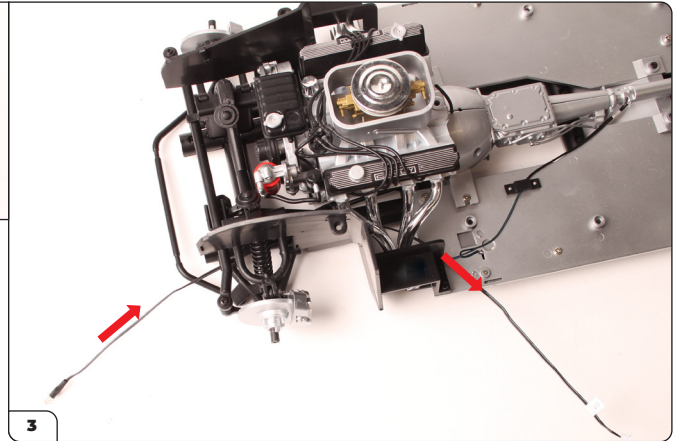
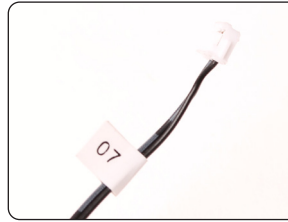

## STEP 3

Place the Main Body upside down on your work surface, supported to protect the Windshield. Sit the chassis assembly in the upright position, as close as possible to the main body in order to connect more cables. Connect 3 pairs of cables – No.s 01, 07 & 08. (before continuing, see our expert tip on the next page).

Lower the chassis onto the main body, tucking the connected cables in.



### IMPORTANT

Check the Oil Cooler Pipes from the Radiator are not trapped as you will need to connect these at a later stage. Also check the LEDs on the ends of cables 07 and 08 are not trapped.

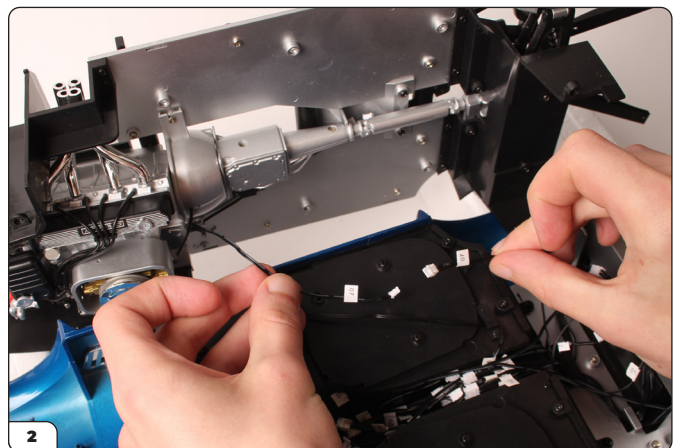
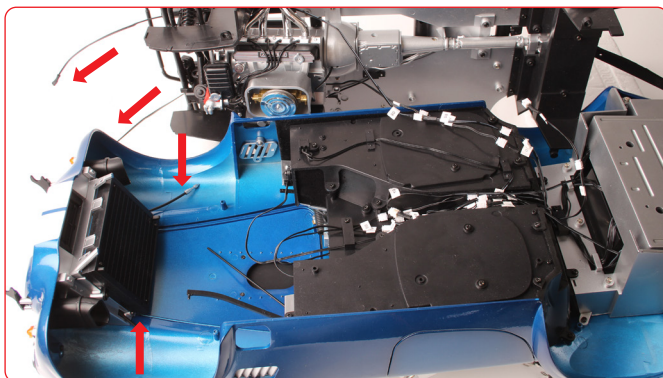
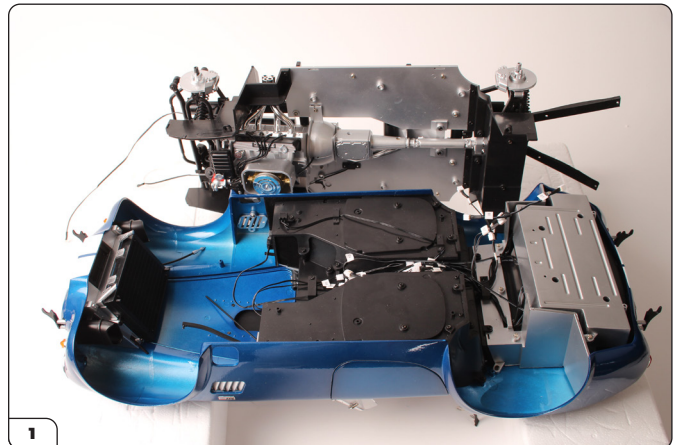



# Stage 99: More Engine Components



## ADVICE FROM THE EXPERTS

Pre-thread the steering column shaft connector (Step 7) with the OD11 screw before fitting the chassis to the body and leave the screw loosely fitting in the hole. Also check that the screw hole is facing up with the wheels straight. If not, adjust the position of the steering rack (stage 68).

## Also:

Make sure that the cable connectors are not laying in the rear of the transmission tunnel, otherwise they will block the prop shaft and stop the chassis fully seating.

## CONTINUED...

Continue pressing the chassis carefully into position until the sides are flush and you are happy with the fit.

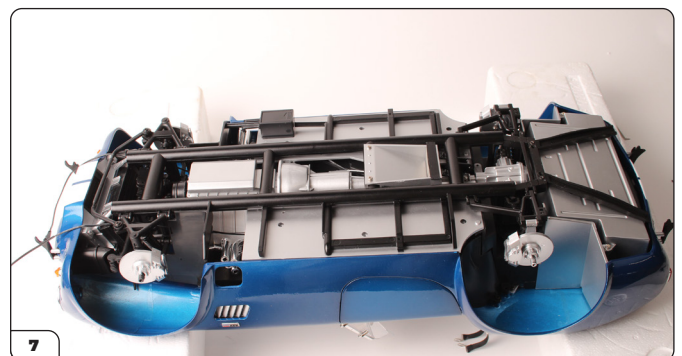
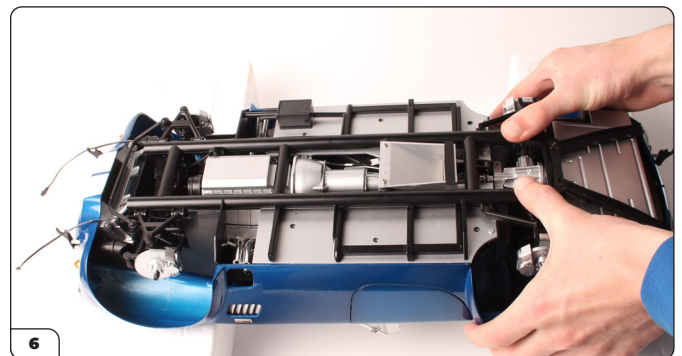
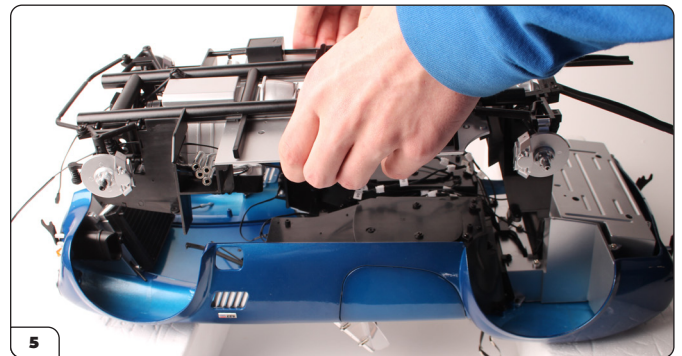
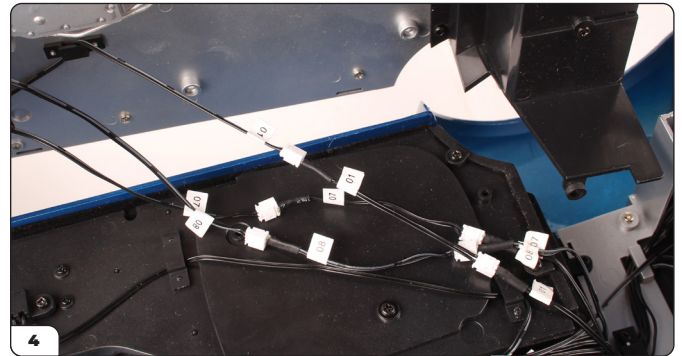
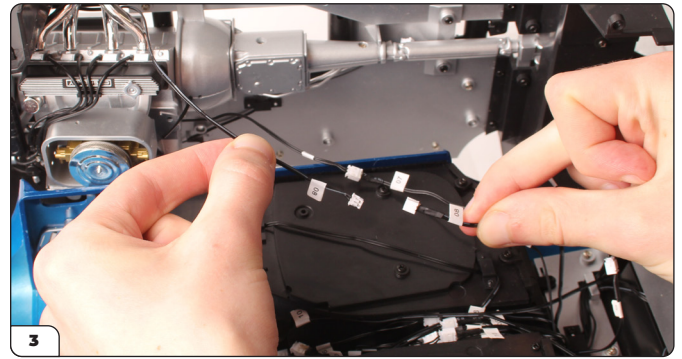



# Stage 99: More Engine Components

## CONTINUED...

Secure in place using 4 x OD05 screws.

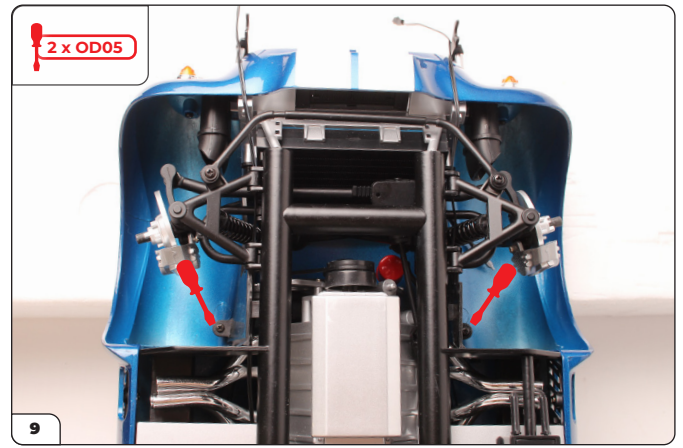
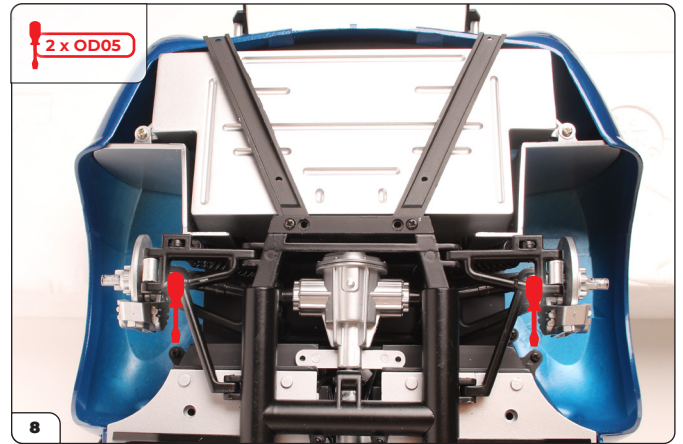

## STEP 4

### ATTACH THE HEADLAMP LEDS

Take the LEDs on the end of cables 07 and 08 and push them into their respective headlamps. It's easier to do this using tweezers.



### ADVICE FROM THE EXPERTS

Now would be a good time to insert 3 x LR44 batteries and test the electronics. Electronic functions can be found on page 61.



# Stage 99: More Engine Components

## STEP 5

### SECURE THE CHASSIS IN PLACE

Continue to secure the chassis in place using 6 x TYPE OP03 screws.

Secure the Wishbone Mounting in place using 4 x TYPE OP08 screws.

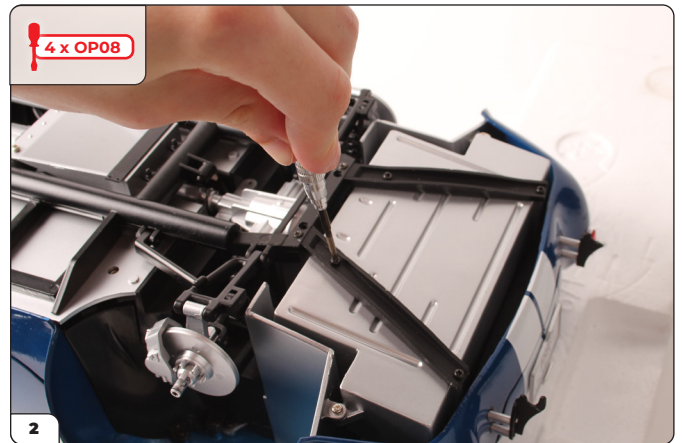
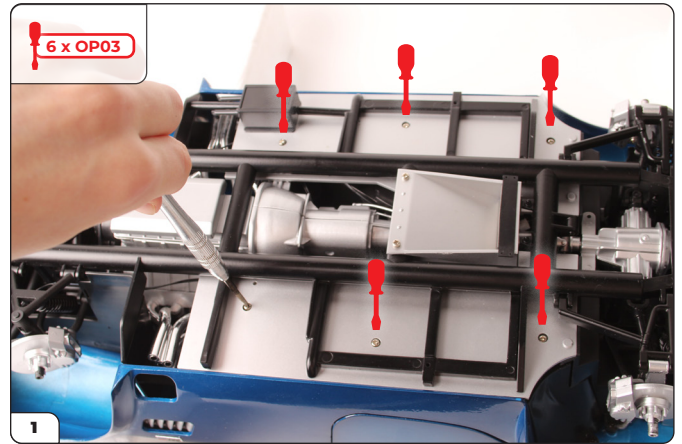

## STEP 6

### RE-ATTACH THE FOUR WHEELS

Re-attach the wheels, checking you have identified the front and back wheels correctly before fixing them using the same screws and spinners removed in Step 1.

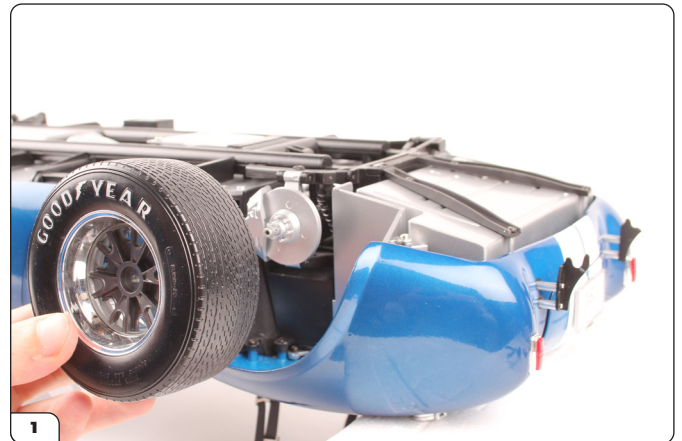



# Stage 99: More Engine Components





# Stage 99: More Engine Components

## STEP 7

### INSTALL MORE COMPONENTS IN THE ENGINE

With your model the right way up on your work surface, open the hood and support it in the open position using the Hood Support. Using long-nose pliers, grip the end of the Steering System Shaft (Stage 67) and attach it to the Steering Column. The steering column assembly passes between the two exhaust pipes. Fix in position using a TYPE OD11 screw that you may have pre-threaded in step 3.

Note: picture 2 shows the Air Intake Pipe (arrow). This should be tucked under the fender and pushed over the locating peg on the fender liner.

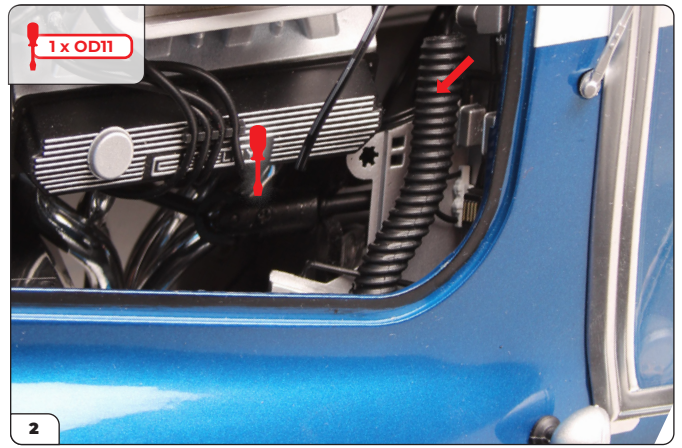
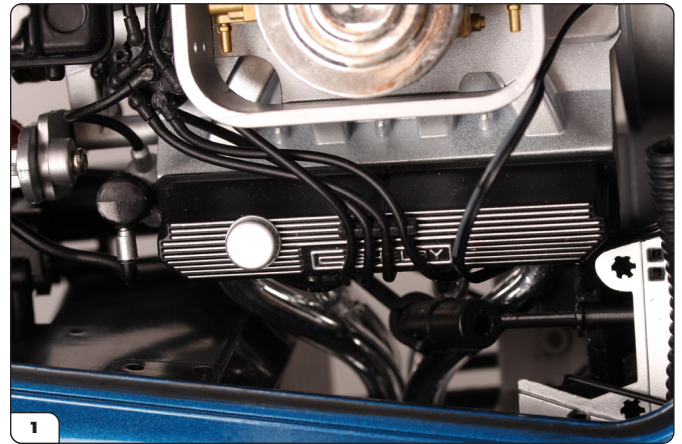

### CONTINUED...

Take the Steering Shaft Top Cover Plate (99d) and lower it into the recess as shown (picture 3). Press firmly.

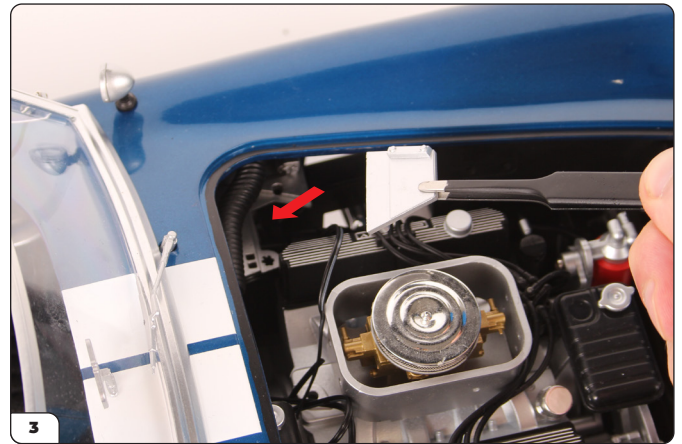

# Stage 99: More Engine Components

## CONTINUED...

Take the Front Lateral Cage Left Bar (99g, picture 5). Press the straight end into the recess on part 99d and the pin at the other curved end into the corresponding hole in that side of the engine wall.

Make sure you don't trap the Firewall Cable Harness (stage 63) under the rear of the Front Lateral Cage Left Bar.



Take Pipe 99e and press one end into Device 9 (Stage 64) and the opposite end into the firewall as shown, picture 6. The holes in the Firewall can be enlarged with an awl or small drill if necessary.

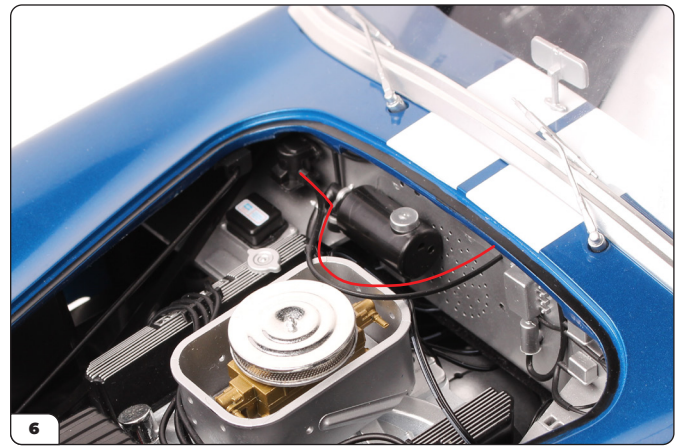

## CONTINUED...

Grip the end of Pipe 99c already installed in step 2 and push the free end into position on the Firewall as shown in picture 7.

Take pipe 99a and push one end into the Oil Vapour Canister and the other end into the remaining hole on the flywheel cover.

Take Fuel pipe 99f and route it around the carburetor as shown, pressing one end into the firewall (see picture 8, inset) and the other end into the Fuel Pump as shown in picture 9.

Caution: When fitting Fuel Pipe 99f be very careful not to dislodge the ignition cables in the distributor.

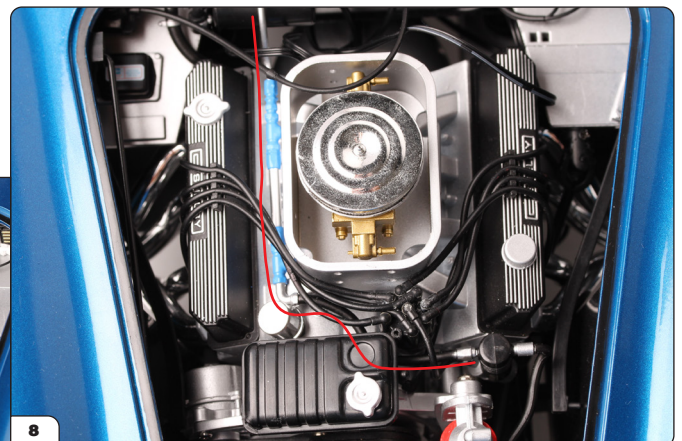
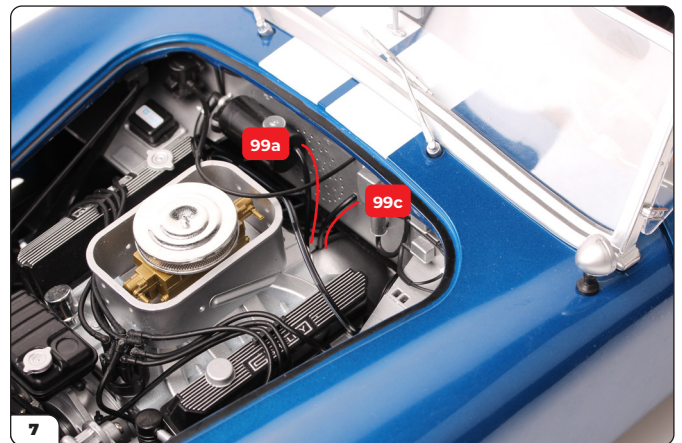



## Stage 99: More Engine Components

---

**Stage 99 complete!**



# Stage 100: Final Engine Components & Attaching the Exhausts

In stage 100, you will add the final engine components and install the iconic Cobra side exhausts.

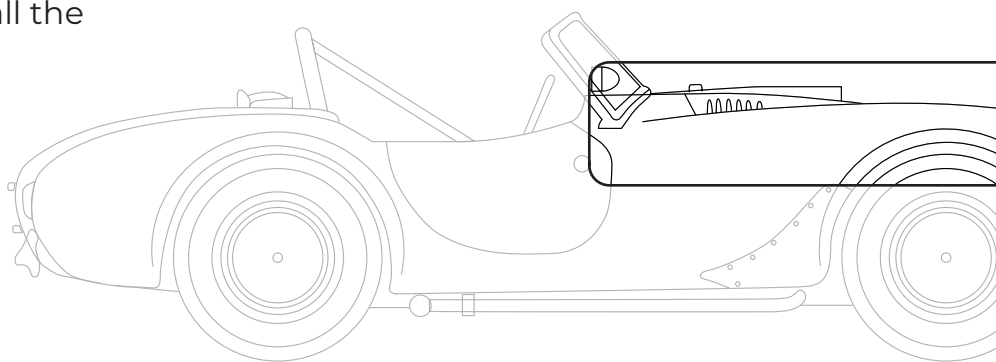

## STAGE 100 PARTS LIST

Name	Quantity
Top radiator large pipe 100a	1
Oil vapour canister large pipe 100b	1
Carburetor actuator system 100c	1
Top radiator small pipe 100d	1
Sway bar mounting brackets	1
Screws TYPE OP17	3
Screws TYPE OD01	3





# Stage 100: Final Engine Components & Attaching the Exhausts

## STEP 1



### ADVICE FROM THE EXPERTS

Tip 1: The hood can be removed easily by removing the two small screws which makes it easier to access to engine bay and complete the details in this final stage.

Tip 2: If necessary, these detail parts can be secured with a tiny drop of superglue.

### FITTING THE REMAINING COMPONENTS TO THE ENGINE

Have your model the right way up on your work surface with the Hood open. Take the Top Radiator Large Pipe (100a) and position it in the engine as shown. One end pushes onto the Expansion Tank and the other end pushes into the back of the radiator.

Then grip the free end of the Left Oil Cooler Hose (fitted in stage 83) and push it into the nozzle on the Oil Filter, pictures 2 & 3.

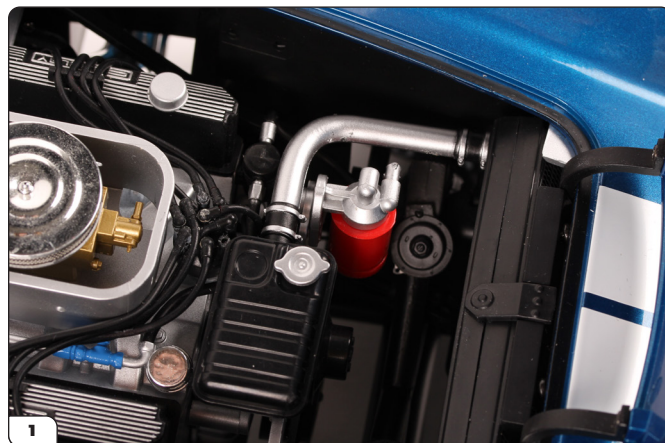

Take the Oil Vapour Canister Large Pipe (100b). Push one end into the Oil Vapour Canister (stage 66) and the other end into the Engine Block (see also picture 5 on the next page).



# Stage 100: Final Engine Components & Attaching the Exhausts

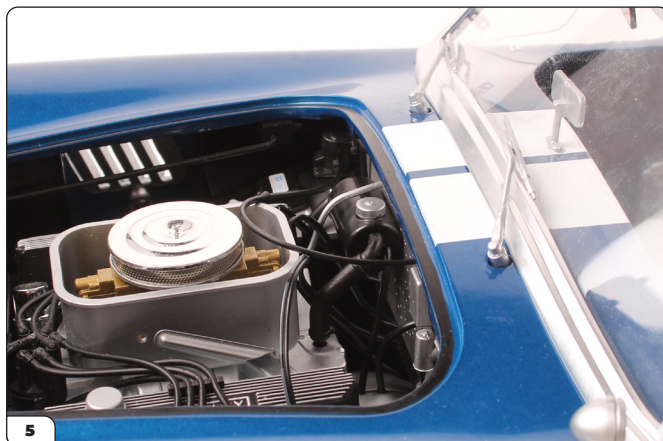

## CONTINUED...

Take the small pipe (100d). Push one end into the back of the Radiator and the other end into the Expansion Tank, pictures 6 & 7.



Take the Carburetor Actuator System (100c) and push the pins onto the the Steering Shaft Top Cover Plate (99d, pictures 8 & 9 below).

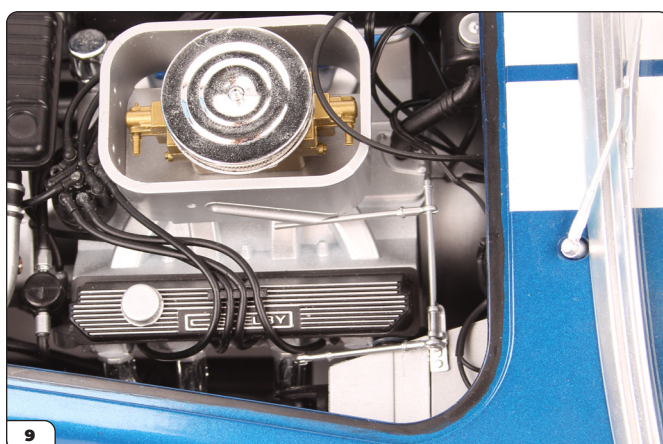



# Stage 100: Final Engine Components & Attaching the Exhausts

## CONTINUED...

Take the Canister Set from stage 98. Lower it into the engine, feeding the three pipes through to the underside. Push the Canister lugs into the holes on the front fender liner.

Close the hood, locking it, and turn your model over, carefully supporting it so that you can work on the underside.

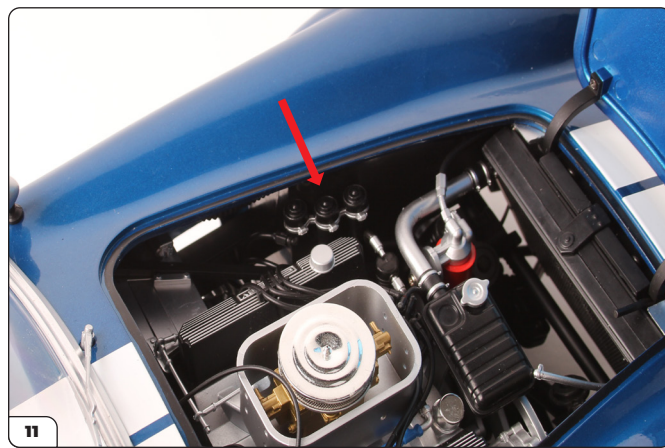
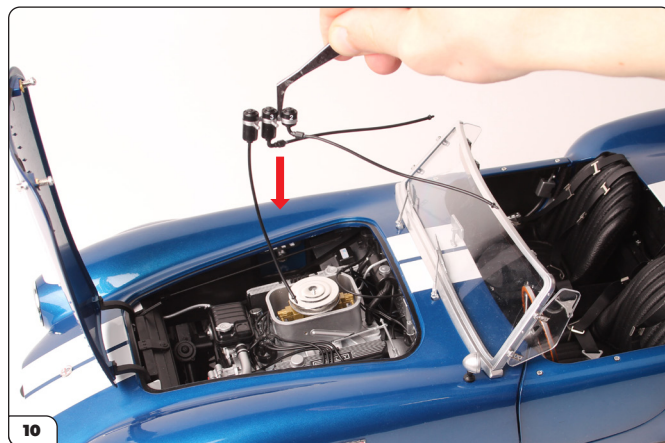

Locate the three pipes that have just been fed through from the Canister Set and attach them to the Mounting Box (stage 48).

Continue working on the underside, adding the Bottom Radiator Large Pipe (stage 98). One end pushes into the radiator, the other end angles down into the front engine plate (stage 05). See picture 13 on the next page.

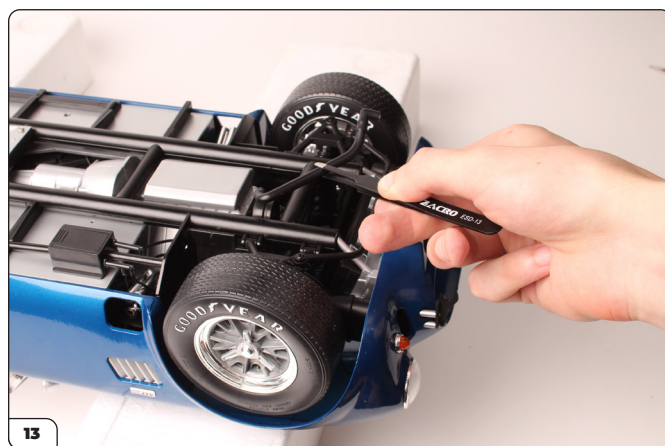
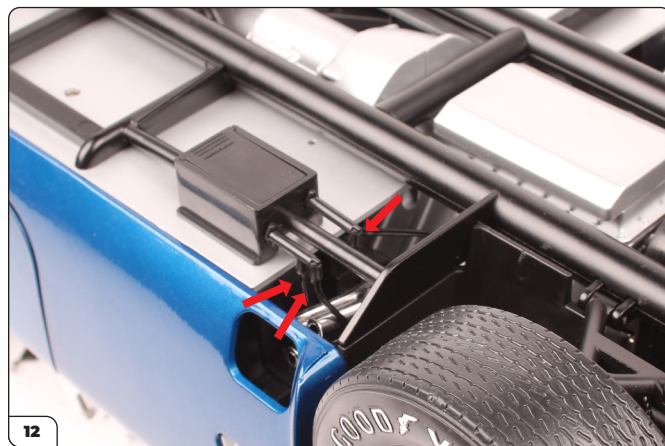



# Stage 100: Final Engine Components & Attaching the Exhausts

CONTINUED...

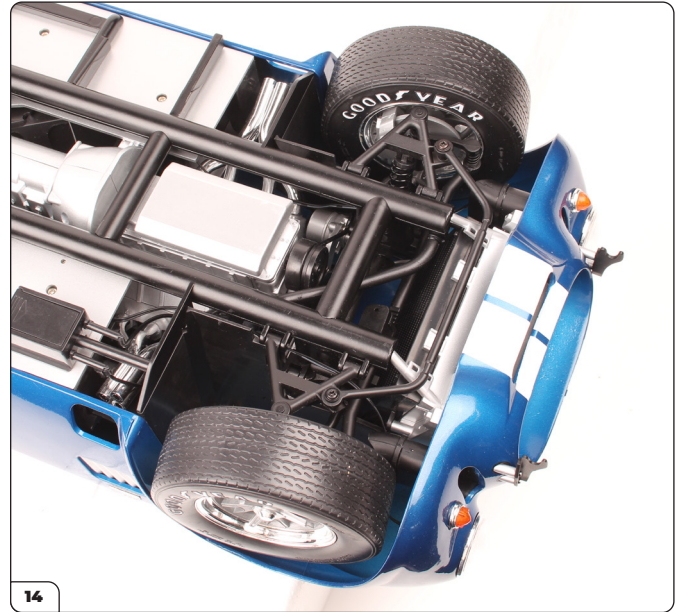

Take the Sway Bar Mounting brackets (100e) and fit them over the Anti-sway Bar. Secure each one using a TYPE OP17 screw.

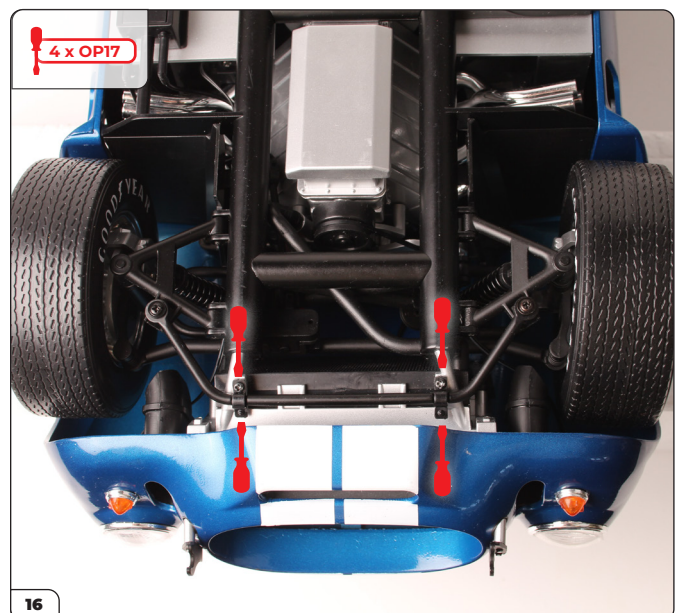
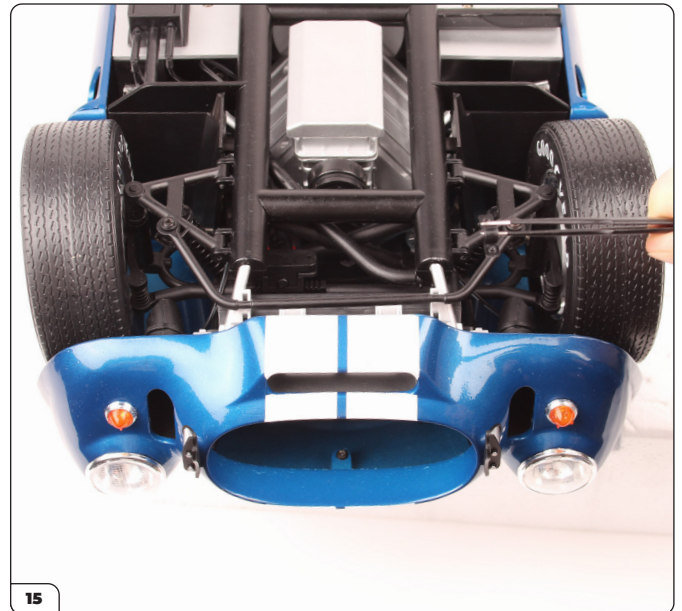

# Stage 100: Final Engine Components & Attaching the Exhausts

## STEP 2

### FIT THE SIDE EXHAUSTS

Push the four Exhaust Elbows into the Exhaust Manifold Pipes. Anchor the Exhaust Tip to the chassis using a TYPE OD01 screw. Repeat on the opposite side to fit the second exhaust.



### ADVICE FROM THE EXPERTS

If the Exhaust Elbows are not fitting into the Exhaust Manifolds, try filing any rough edges and re-fit, adding a drop of superglue if necessary.

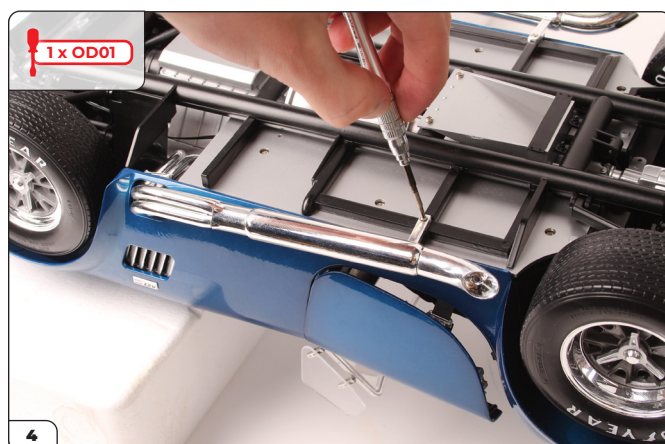
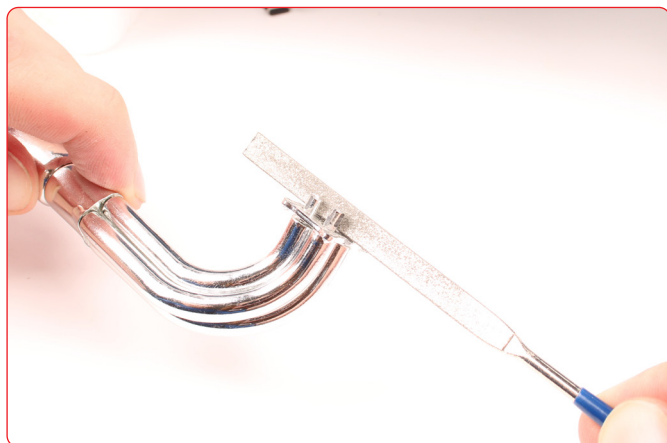



# Stage 100: Final Engine Components & Attaching the Exhausts

## STEP 3

### INSTALL THE BATTERIES AND CHECK THE ELECTRICAL COMPONENTS

The batteries required are 3 x LR44 or AG13. These are not supplied with your build. Slide open the battery box cover on the underside of your model. It might help to tape the doors closed while you turn the car over. Insert the batteries with the positive side facing the spring, and replace the cover.

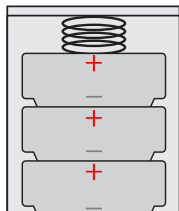

### Electrical functions:

The main on/off switch is located between the seats. This switch operates the headlights.

The brake pedal operates the stop lights.

The button on the dashboard operates the horn.

The accelerator pedal operates engine sound.

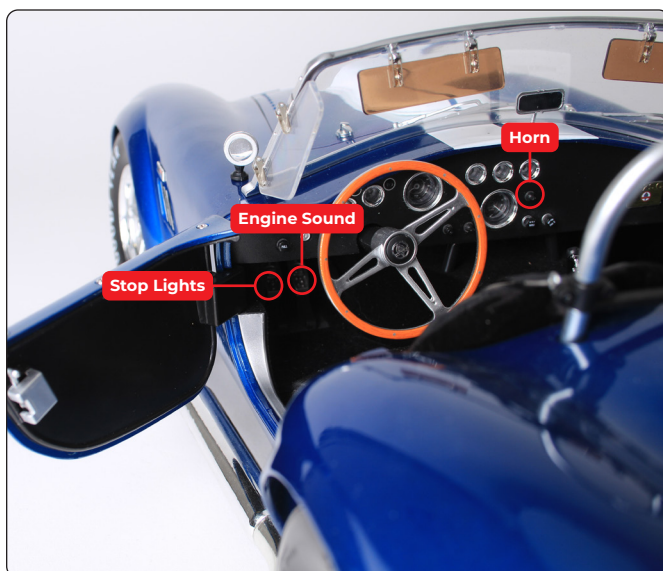



## Stage 100: Final Engine Components & Attaching the Exhausts

---

**Stage 100 complete!**



**Stage Complete! We hope you have enjoyed building your 1965 Shelby Cobra 427 SC. Don't forget, when you choose your next model the first Pack is absolutely free! Go to [agoramodels.com](http://agoramodels.com) for more details.**

Display cases for your model are also available at [agoramodels.com](http://agoramodels.com).

**!** Warning: to keep your model in pristine condition please keep out of direct sunlight.