

1 9 6 5

SHELBY COBRA

427 SEMI-COMPETITION

1:8 SCALE



Pack 02 | Build Instructions

In the 1960s, Carroll Shelby's Cobras dominated racetracks worldwide, first winning races coast to coast across North America, then in 1965, winning the World Manufacturer's GT Championship, achieving the ultimate goal of defeating Ferrari. The Semi-Competitions were modified from full competition models just enough to make them street legal. Only 29 models were produced, making them one of the most sought-after American sports cars by collectors.

Your 1:8 model replicates the original 1965 Semi-Competition Cobra in intricate detail. From the detail on the dashboard dials to the writing on the wheels, every piece is precisely reproduced.

In your second model pack, you will continue to build the Cobra 427 engine:

STAGE 07: ASSEMBLING THE ALTERNATOR

**STAGE 08: WATER PUMP PULLEY, CRANK
SHAFT PULLEY AND TIMING BELT COVER**

**STAGE 09: LEFT CYLINDER HEAD COVER AND
EXHAUST MANIFOLD PIPES**

**STAGE 10: RIGHT CYLINDER HEAD COVER AND
EXHAUST MANIFOLD PIPES**

**STAGE 11: ROCKER COVERS, CAPS AND SPARK
WIRE HOLDERS**

**STAGE 12: DISTRIBUTOR, FUEL FILTER,
IGNITION COIL AND CYLINDER HEAD CAP**

**STAGE 13: ENGINE BLOCKS AND COOLING
FLUID TANK BRACKET**

**STAGE 14: FLYWHEEL COVER, GEARBOX,
INSPECTION COVER, GEARBOX RODS**

**STAGE 15: OIL PAN, PROTECTIVE PLATE,
SPARK PLUGS, SPARK PLUG WIRE AND WIRE
CONNECTORS**

Stage 07: Assembling the Alternator

In stage 07, you will add the alternator to the oil filter assembly from stage 05.

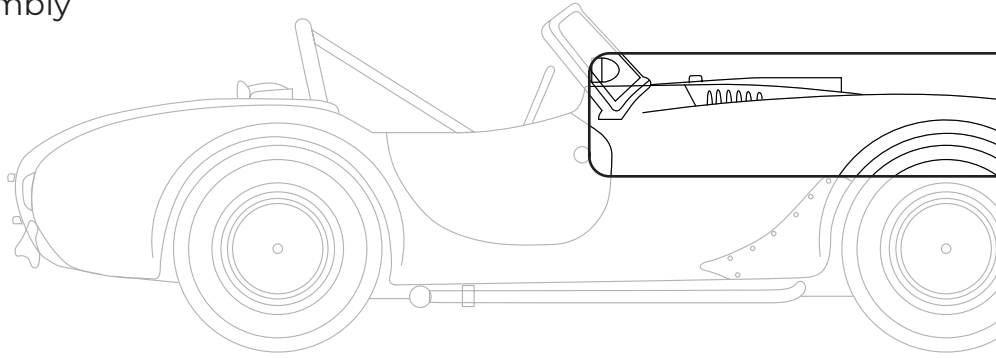

STAGE 07 PARTS LIST

Name	Quantity
Alternator housing	1
Alternator bottom	1
Pulley	1
Mounting plate	1
Mounting arm	1
Screws type OP03	2 [including 1 spare]
Screws type OP06	5 [including 1 spare]



Stage 07: Assembling the Alternator

STEP 1

ASSEMBLE THE ALTERNATOR AND ATTACH IT TO THE OIL FILTER ASSEMBLY

Align the two lugs on the alternator housing with the tiny holes on the alternator bottom. Position the pieces together. Push the pulley through the hole in the alternator housing, checking that the notch on the pulley and the corresponding recess are correctly aligned. Fix together using a TYPE OP03 screw inside the barrel of the alternator bottom.

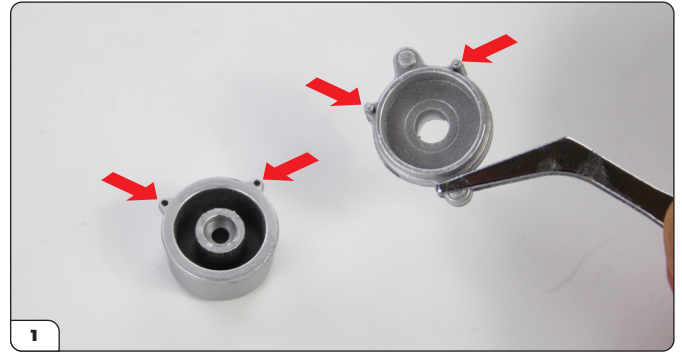

Stage 07: Assembling the Alternator

STEP 2

Align the tiny holes on the mounting arm and the alternator as shown (study the photo carefully to check you have the parts the correct way up). Fix together using a TYPE OP06 screw. Align the holes on the mounting plate and the alternator in a similar way, and fix using another TYPE OP06 screw, taking care not to overtighten. Push the opposite ends of the arm and the plate parts towards each other so that the end of the mounting arm fits snugly into the recess on the mounting plate. Then take the oil filter assembly and align this part with the two screw holes as shown. Fix together using 2 x TYPE OP06 screws.



ADVICE FROM THE EXPERTS

Leave all the screws slightly loose until they are all in place, then gently tighten them. This will make it easier to align the holes.

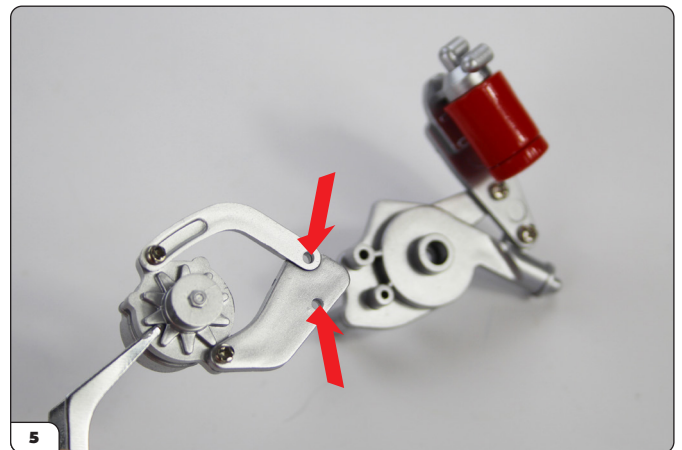
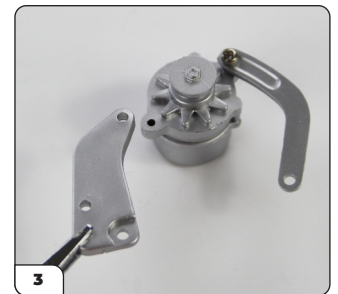
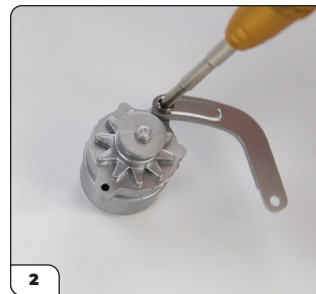

Stage 07: Assembling the Alternator

Stage 07 complete!



Stage 08: Water Pump Pulley, Crank Shaft Pulley and Timing Belt Cover

In stage 08, you will continue to build the engine

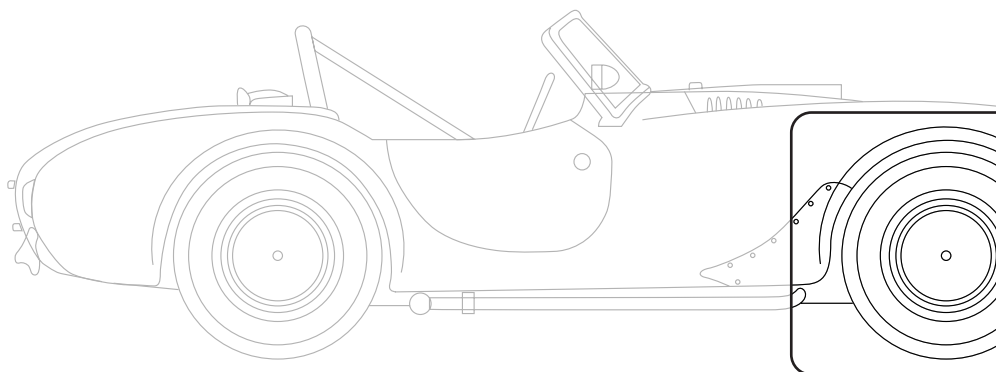

STAGE 08 PARTS LIST

Name	Quantity
Timing Belt Cover	1
Timing Belt	1
Water Pump Pulley Part 1	1
Water Pump Pulley Part 2	1
Crank Shaft Pulley Part 1	1
Crank Shaft Pulley Part 2	1
Screws TYPE OP05	2 [including 1 spare]
Screws Type OP03	4 [including 1 spare]
Screws TYPE OP07	2 [including 1 spare]



Stage 08: Water Pump Pulley, Crank Shaft Pulley and Timing Belt Cover

STEP 1

ASSEMBLE THE WATER PUMP AND CRANK SHAFT PULLEYS

Hold the water pump pulley part 1 so that the two lugs are facing up. In your other hand, hold the water pump pulley part 2 so that the central lug is facing outwards. Locate the inner two lugs and holes so that the parts fit together evenly. There is only one correct way to fit them. If the fit isn't square, turn one part 180 degrees and try the fit again. Fix the parts together using a TYPE OP05 screw. Then align the holes and lugs on the crank shaft pulley as shown in picture 4. Push together until they click into place and then fix securely using a TYPE OP03 screw.

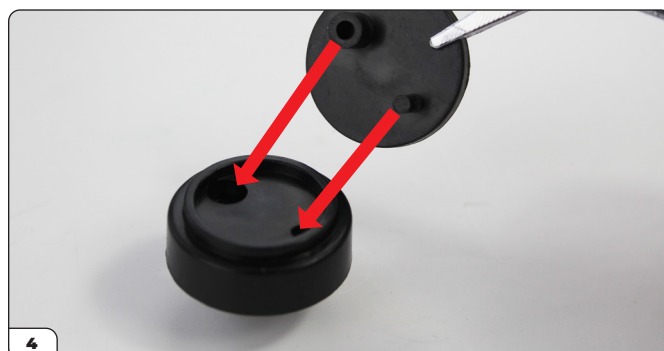

Stage 08: Water Pump Pulley, Crank Shaft Pulley and Timing Belt Cover

STEP 2

ATTACH THE PULLEYS AND TIMING BELT COVER COVER

Align the lug on the water pump pulley with the hole on the assembly from stage 07. Fix the parts together from the reverse side using a TYPE OP03 screw. Align the holes on the timing belt cover with the assembly and fix together using a TYPE OP03 screw. Don't overtighten to allow the parts to sit flat. Take the crank shaft pulley and align the lugs and holes with the timing belt cover as shown. Fix in place with a TYPE OP07 screw.

Take the timing belt and wrap it around both pulleys and the alternator as shown. The timing belt should fit neatly within the grooves on the pulleys.

! ADVICE FROM THE EXPERTS
It might help to hold the assembly with a cleaning cloth to stop the parts slipping as you fix the screws.

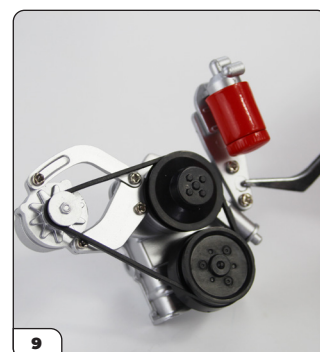
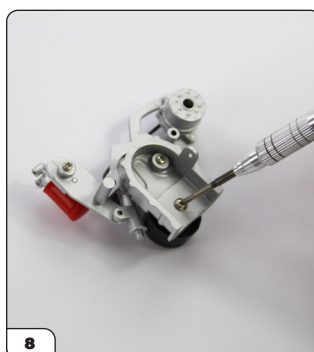
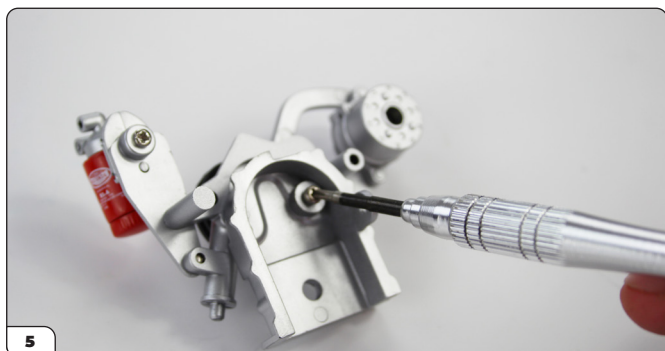
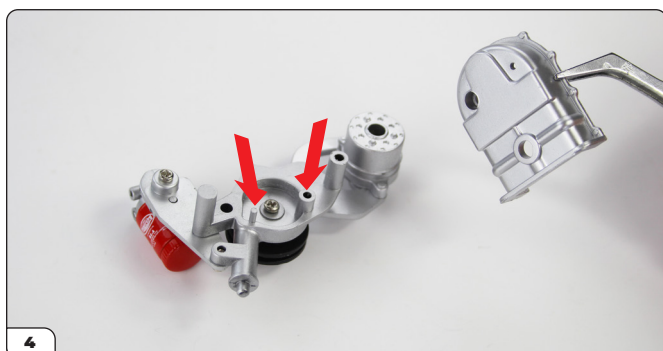
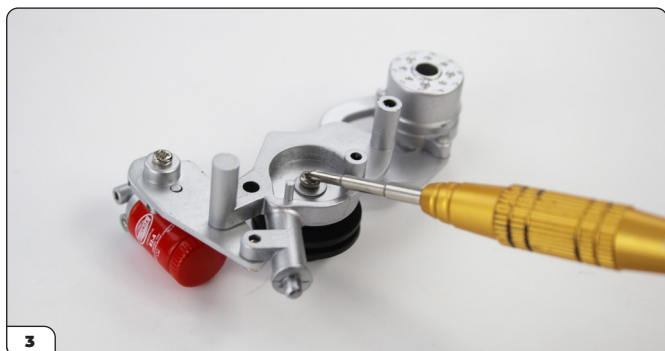
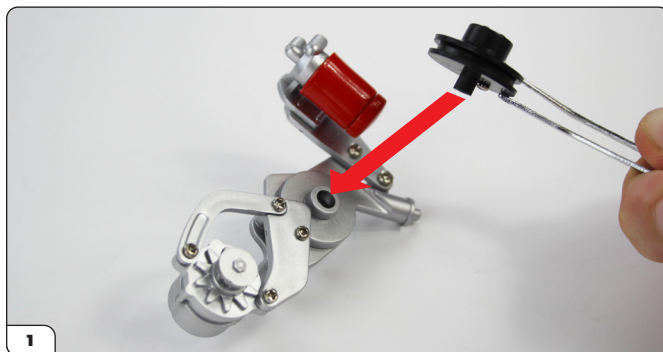

Stage 08: Water Pump Pulley, Crank Shaft Pulley and Timing Belt Cover

Stage 08 complete!

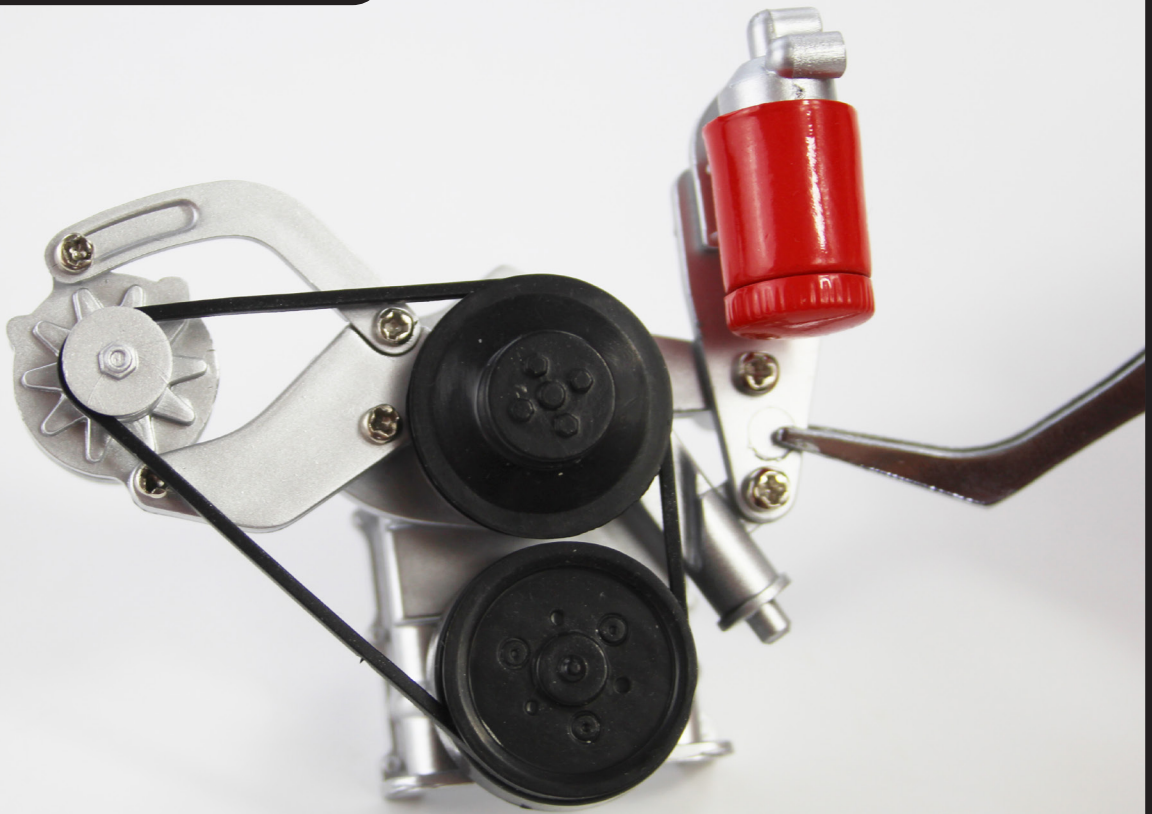

Stage 09: Left Cylinder Head Cover and Exhaust Manifold Pipes

In stage 09 you will continue to build the engine.

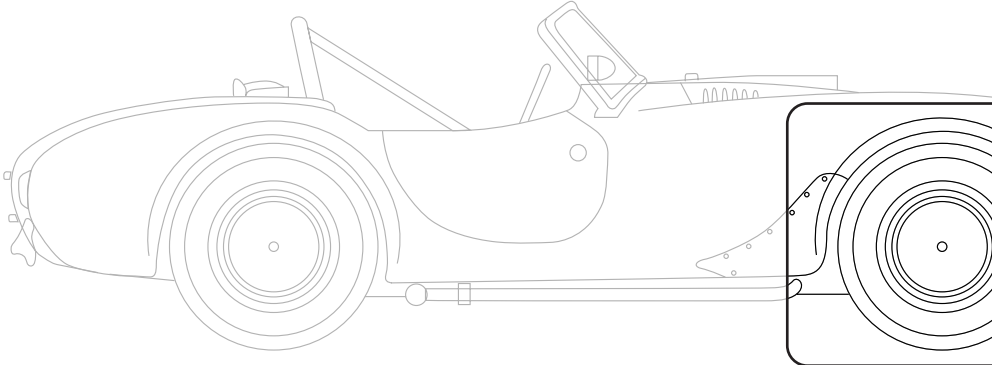

STAGE 09 PARTS LIST

Name	Quantity
Left Cylinder Head Cover	1
Exhaust Manifold Pipe 1	1
Exhaust Manifold Pipe 2	1
Exhaust Manifold Pipe 3	1
Exhaust Manifold Pipe 4	1

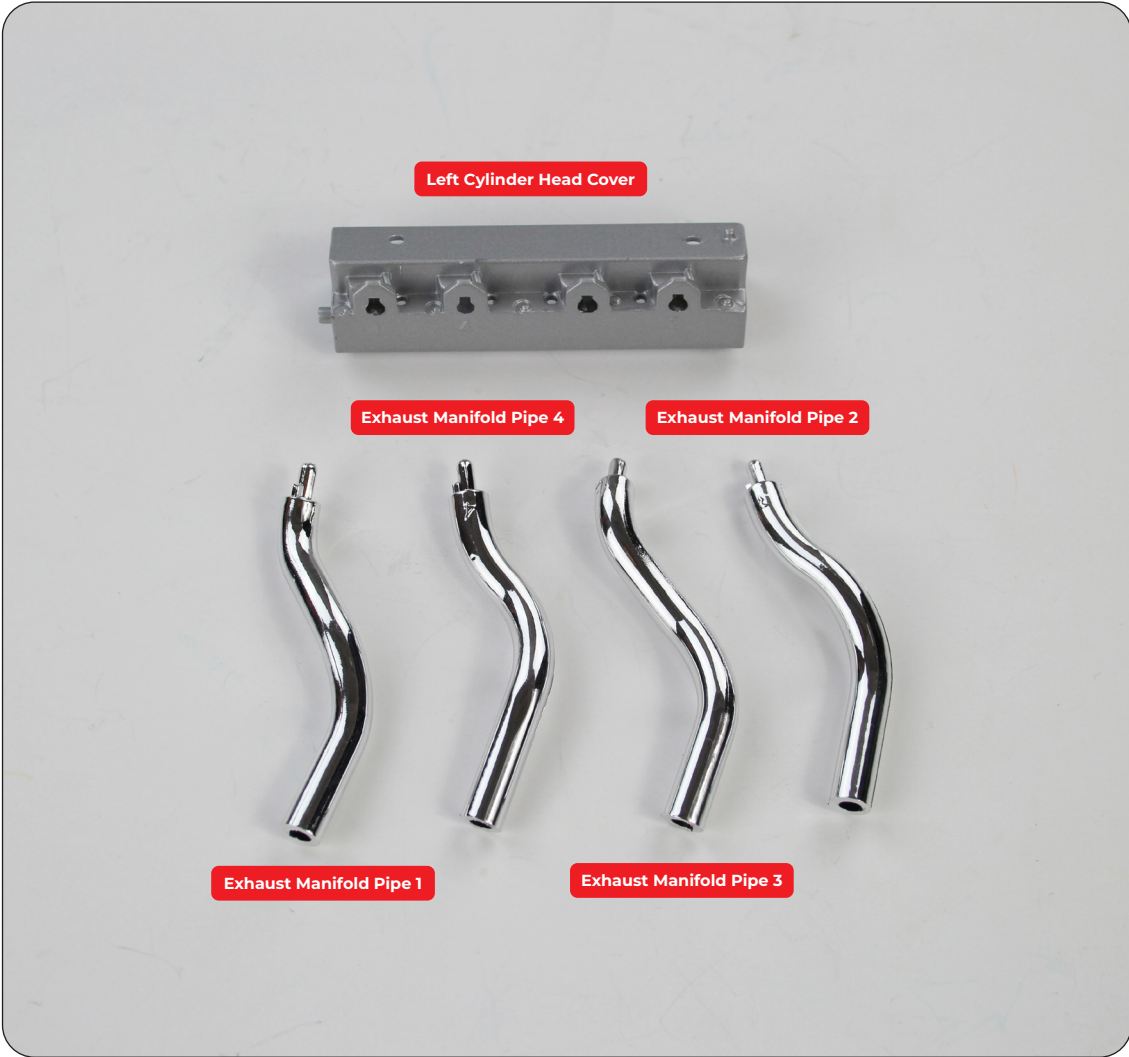

Stage 09: Left Cylinder Head Cover and Exhaust Manifold Pipes

STEP 1

ASSEMBLE THE LEFT CYLINDER HEAD

Note that the left cylinder head has numbered holes along its length: 1, 4, 3, 2. The exhaust pipes are also numbered at each end. Push each numbered pipe into its corresponding hole in the following order: Start with 3, then follow with 4, 1, and finally, 2. Push firmly.



ADVICE FROM THE EXPERTS

Scrape off any mold marks or fish on the locations pegs if the pipes don't go all the way in.

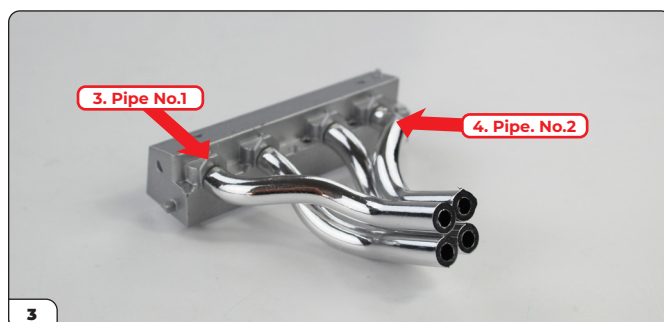
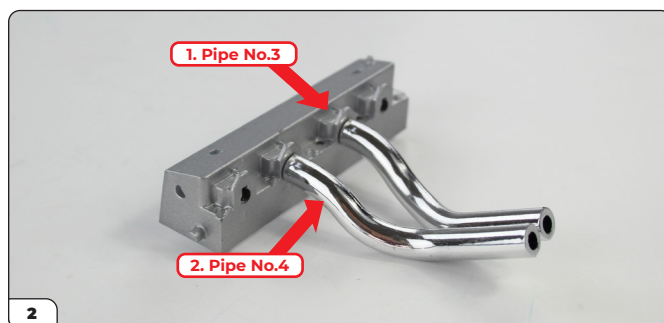
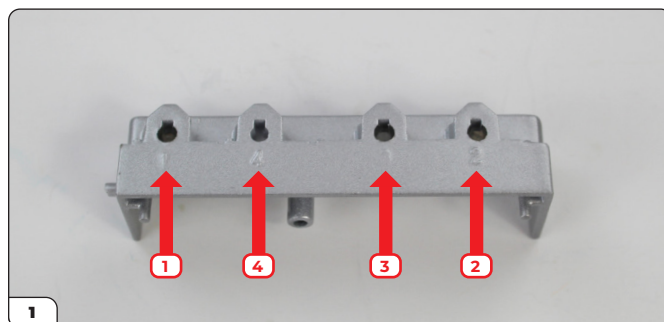

Stage 09 complete!

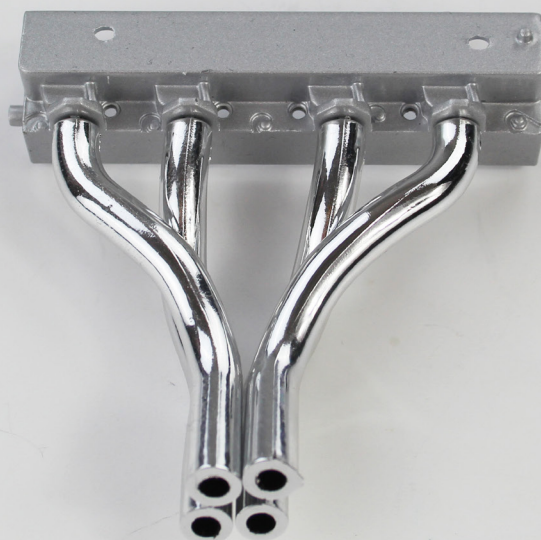

Stage 10: Right Cylinder Head Cover and Exhaust Manifold Pipes

In stage 10 you will continue to build the engine.

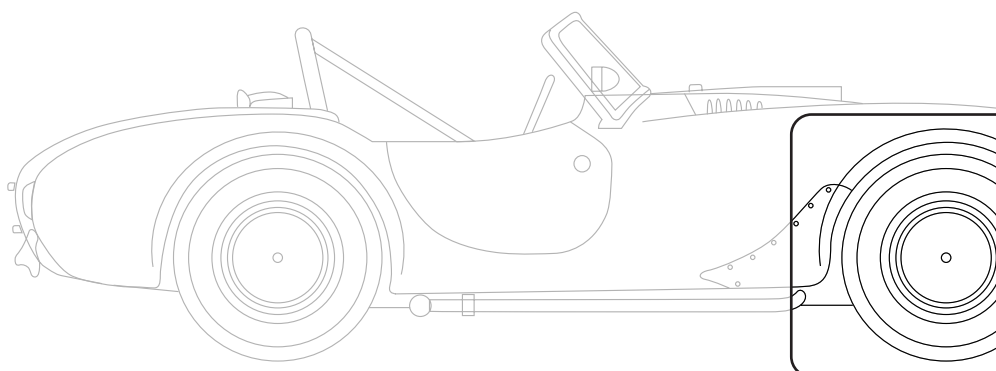

STAGE 10 PARTS LIST

Name	Quantity
Right Cylinder Head Cover	1
Exhaust Manifold Pipe 5	1
Exhaust Manifold Pipe 6	1
Exhaust Manifold Pipe 7	1
Exhaust Manifold Pipe 8	1

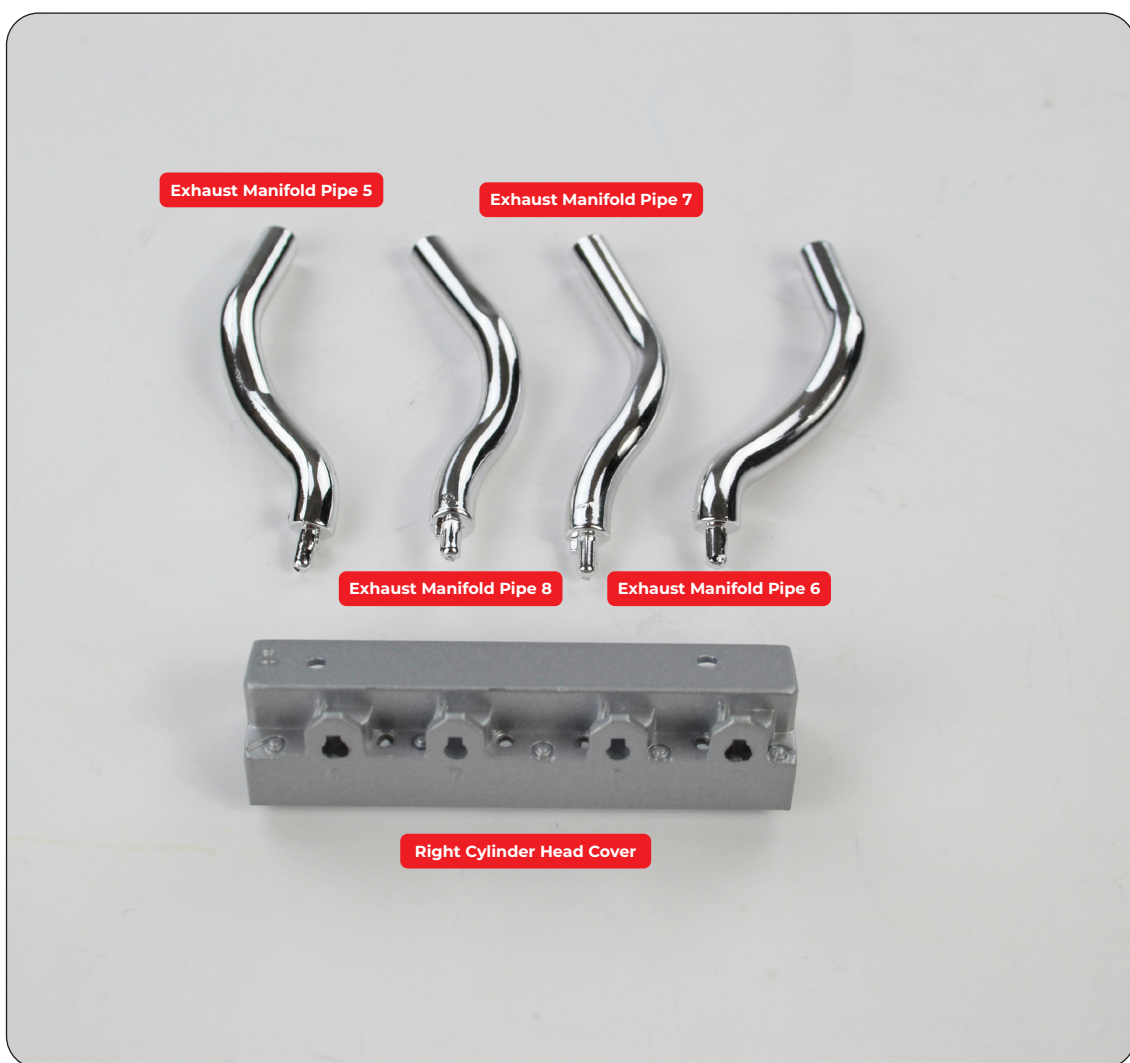

Stage 10: Right Cylinder Head Cover and Exhaust Manifold Pipes

STEP 1

ASSEMBLE THE RIGHT CYLINDER HEAD

Note that the right cylinder head has numbered holes along its length: 6, 7, 8, 5. The exhaust pipes are also numbered at each end. Push each numbered pipe into its corresponding hole in the following order: Start with 8, then follow with 7, 6, and finally, 5. Push firmly.

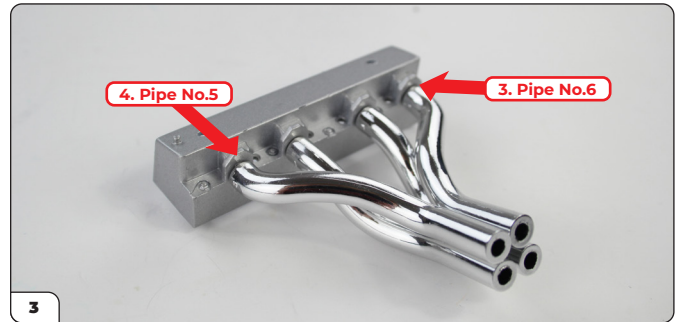
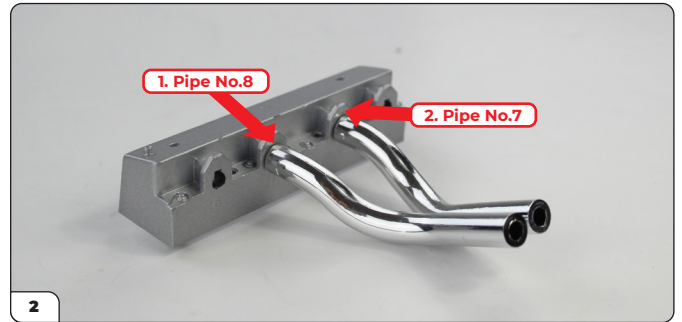
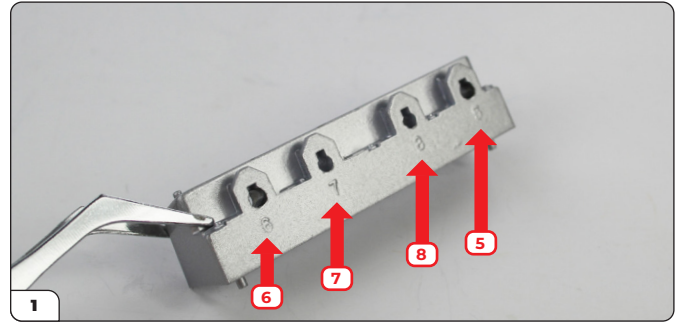

Stage 10 complete!



Stage 11: Rocker Covers, Caps and Spark Wire Holders

In stage 11, the engine will continue to take shape.

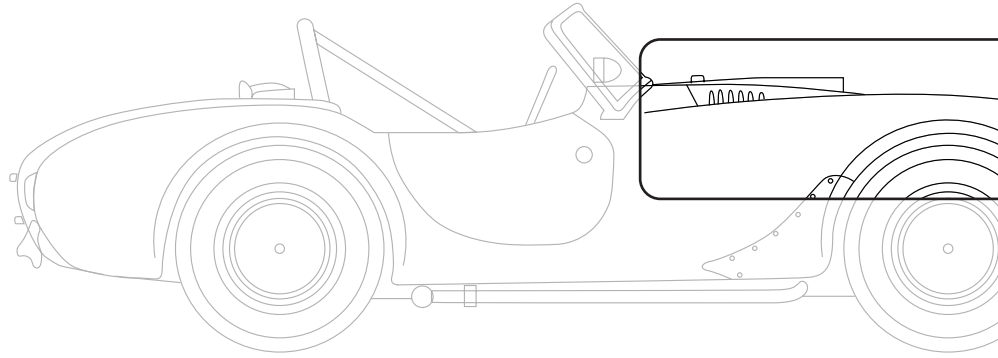

STAGE 11 PARTS LIST

Name	Quantity
Left Rocker Cover	1
Left Rocker Cover Cap	1
Left Spark Wire Holder	1
Right Rocker Cover	1
Right Rocker Cover Cap	1
Right Spark Wire Holder	1
Screws TYPE OP05	2 [including 1 spare]
Screws TYPE OP03	5 [including 1 spare]



Stage 11: Rocker Covers, Caps and Spark Wire Holders

STEP 1

ATTACH THE ROCKER COVER CAPS

Take the right rocker cover cap and align it with the hole on the right rocker cover. Push into place. Check that the holes line up, ready for the screw. If not, rotate the cap 180 degrees and try again. Secure with a TYPE OP05 screw.

Take the left cover cap and position it on the left rocker cover. Push into place – no screws are required here.

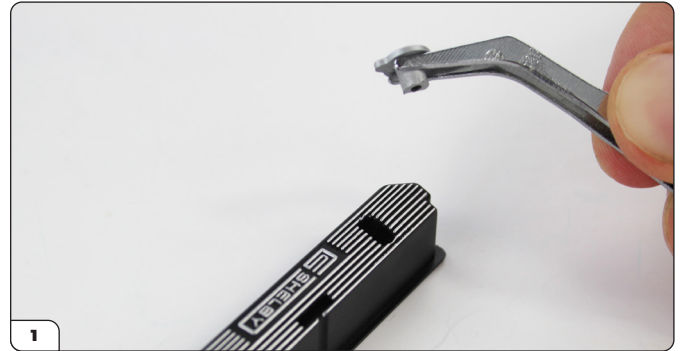

Stage 11: Rocker Covers, Caps and Spark Wire Holders

STEP 2

ATTACH THE ROCKER COVERS TO THE EXHAUST MANIFOLDS

Align the left cylinder head cover from stage 09 with the left rocker cover. Note, the right cylinder head cover has flat ends; the left cylinder head cover has a lug projecting from one end. Place the parts together and secure with 2 x TYPE OPO3 screws. Repeat with the right cylinder head cover and the right rocker cover.

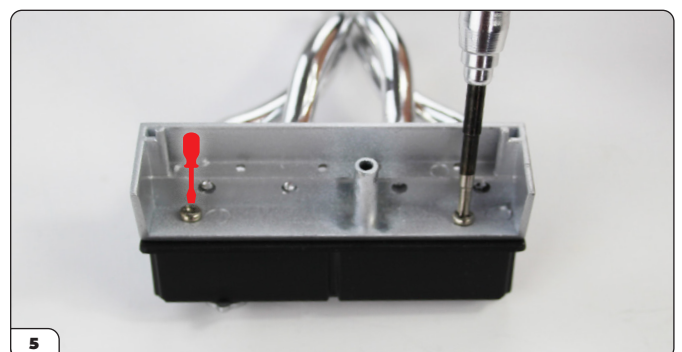
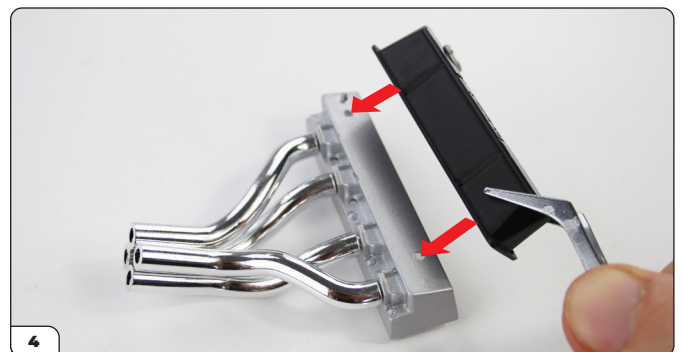
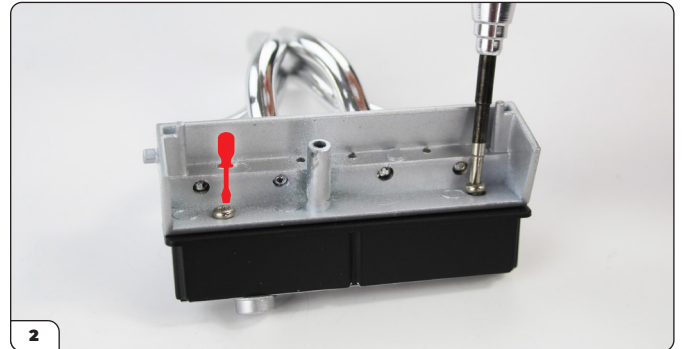
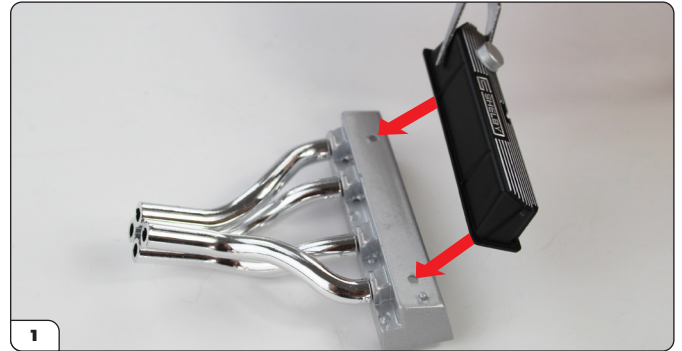

Stage 11: Rocker Covers, Caps and Spark Wire Holders

STEP 3

ATTACH THE SPARK WIRE HOLDERS

Push the spark wire holders into position on the left and right rocker covers as shown. The spark wire clip has a flat side and a tapered side. The flat side should go towards the Shelby Logo.



ADVICE FROM THE EXPERTS

If the spark wire clip is difficult to inset, clear the slot in the rocker cover with a pointed craft knife.



Stage 11: Rocker Covers, Caps and Spark Wire Holders

Stage 11 complete!



Stage 12: Distributor, Fuel Filter, Ignition Coil and Cylinder Head Cap

In stage 12 the engine will continue to take shape.

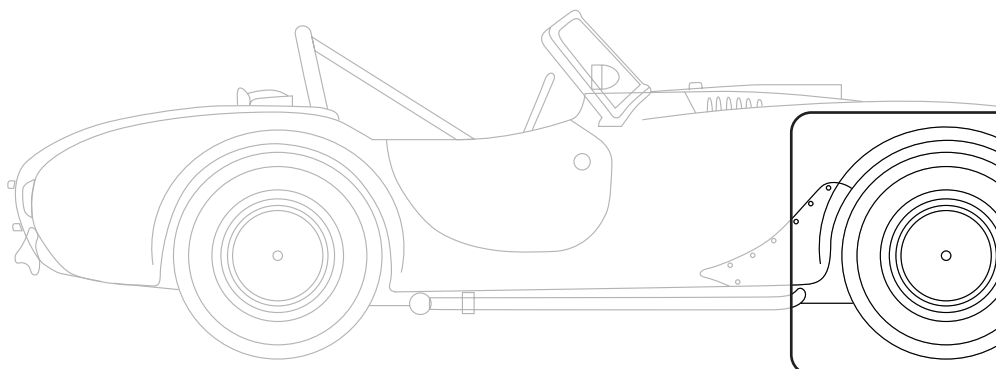

STAGE 12 PARTS LIST

Name	Quantity
Ignition Distributor	1
Ignition Coil	1
Cylinder Head Central Cover cap	1
Fuel Filter	1
Screw TYPE OP03	3 [including 1 spare]



Stage 12: Distributor, Fuel Filter, Ignition Coil and Cylinder Head Cap

STEP 1

ADD COMPONENTS TO THE ENGINE BLOCK ASSEMBLY

Take the engine block assembly from Stage 04 and position the distributor in one corner as shown. Secure in place with a TYPE OP03 screw. Position the fuel filter on the opposite corner as shown. Secure with a TYPE OP03 screw.

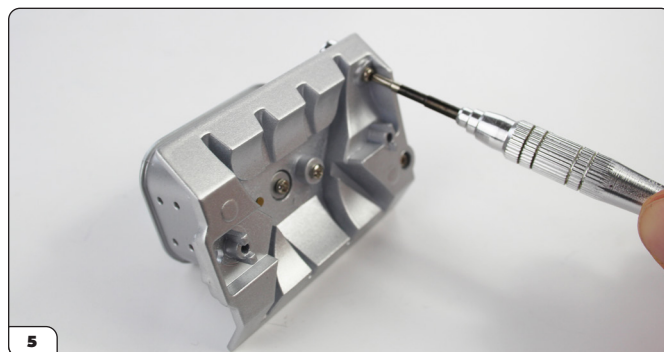
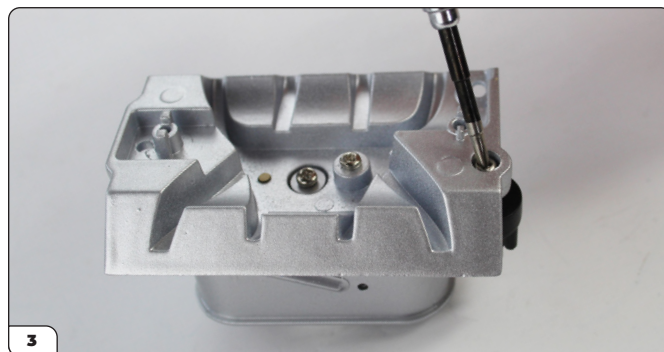

Stage 12: Distributor, Fuel Filter, Ignition Coil and Cylinder Head Cap

STEP 2

ADD COMPONENTS TO THE LEFT CYLINDER HEAD ASSEMBLY

Take the left cylinder head assembly from stage 09. Attach the cylinder head cover cap to the end as shown, pushing it firmly into position. Take the ignition coil and position it below the cylinder head cover cap. You will feel it click into position when correctly attached.

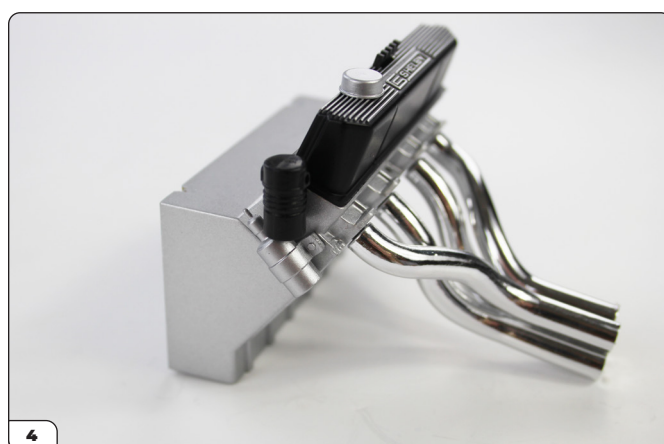
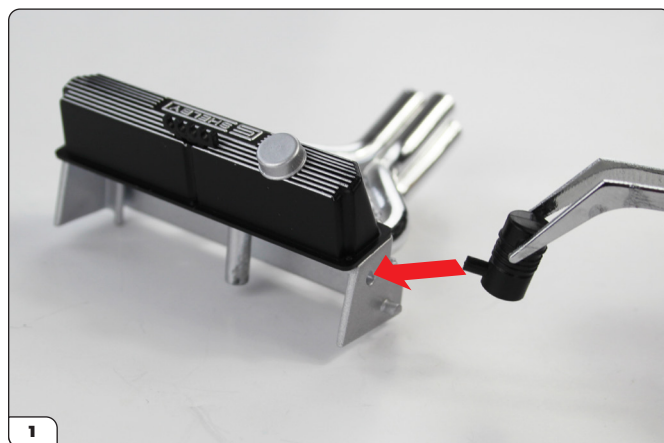

Stage 12: Distributor, Fuel Filter, Ignition Coil and Cylinder Head Cap

Stage 12 complete!

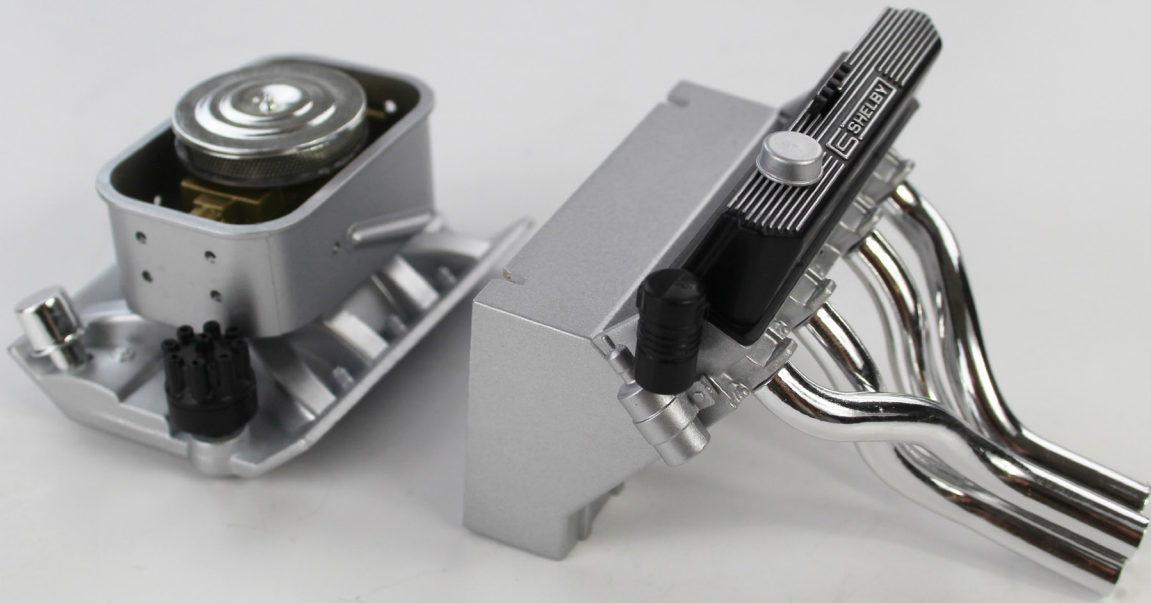

Stage 13: Engine Blocks and Cooling Fluid Tank Bracket

In stage 13 the engine will continue to take shape.

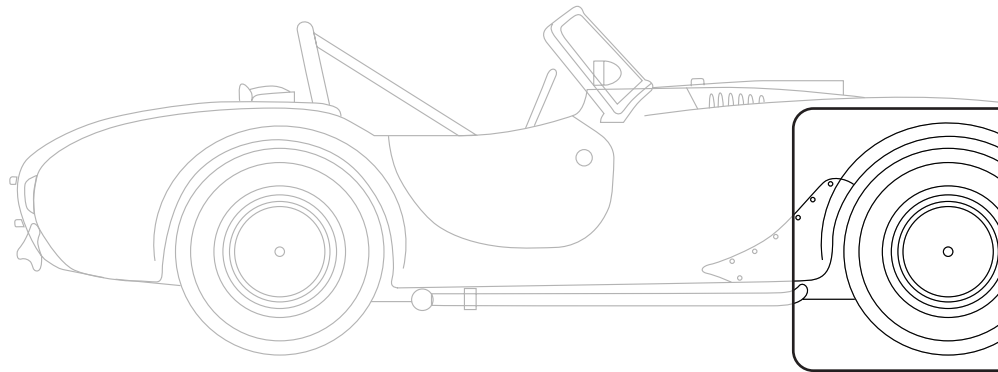

STAGE 13 PARTS LIST

Name	Quantity
Left Engine Block	1
Right Engine Block	1
Cooling Fluid Tank Bracket	1
Screws TYPE OD03	3 [including 1 spare]

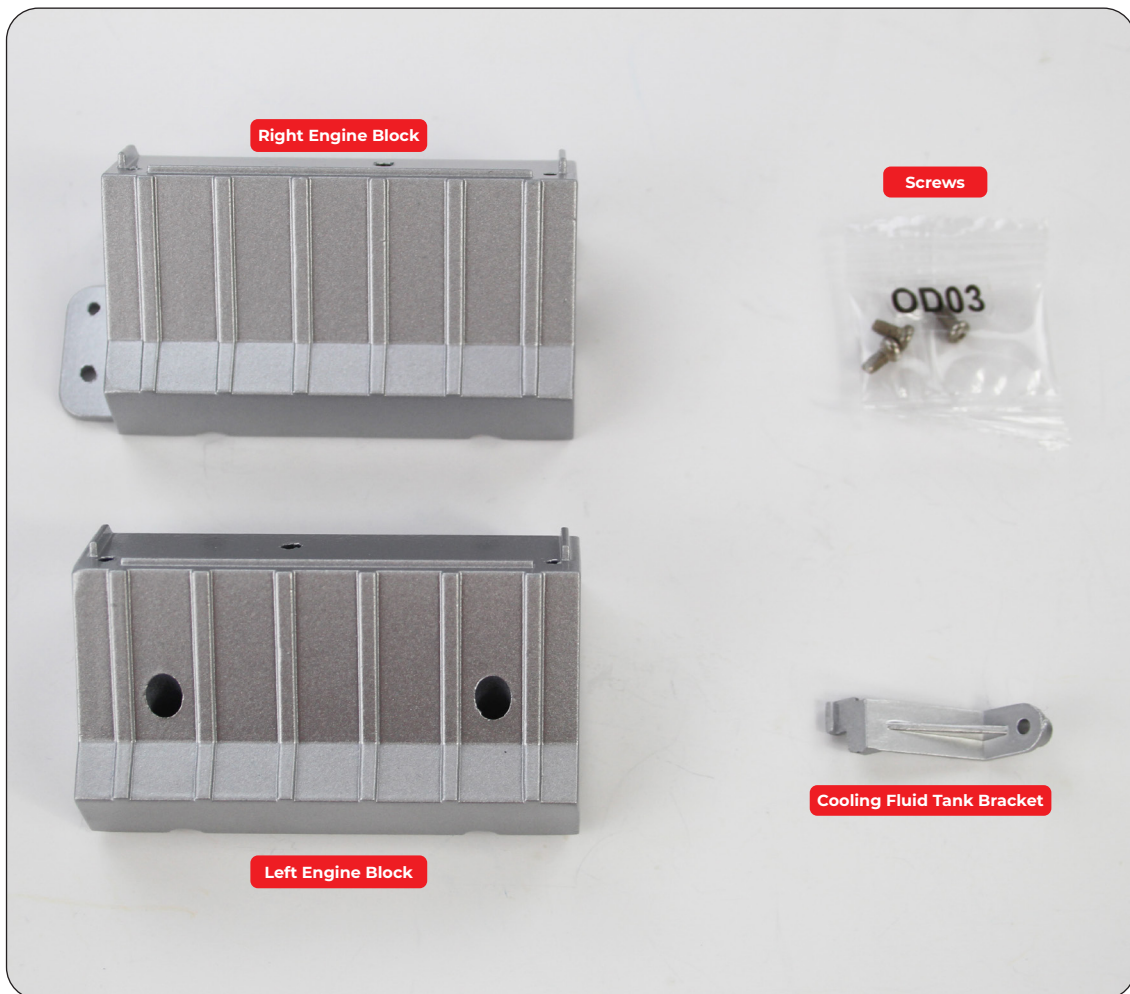

Stage 13: Engine Blocks and Cooling Fluid Tank Bracket

STEP 1

ATTACH THE CYLINDER HEADS TO THE ENGINE BLOCKS

Identify the left and right engine blocks by the letters 'L' and 'R' on the underside of each part. Align the right engine block with the right cylinder head assembly from stage 10. There are 3 lugs that correspond with three holes. Wiggle the parts gently back and forth to drill the lugs into the holes. Secure in place using a TYPE OD03 screw. Repeat with the left engine block and left cylinder head assembly from stage 12 step 2, securing in place with another TYPE OD03 screw.

The Cooling Fluid Tank Bracket will be attached in a later stage.



ADVICE FROM THE EXPERTS

A drop of light oil on the screw threads will make it easier to drive them home.

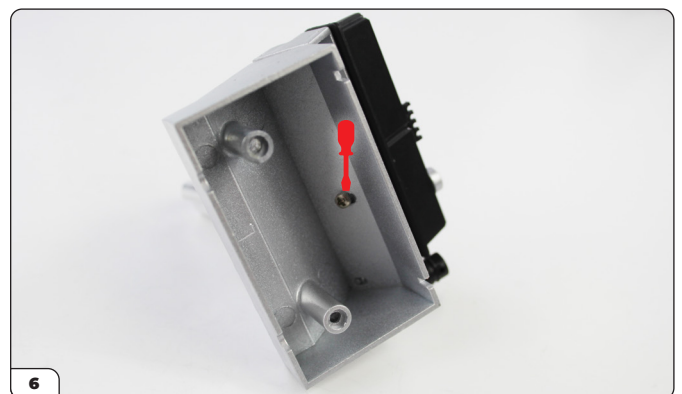
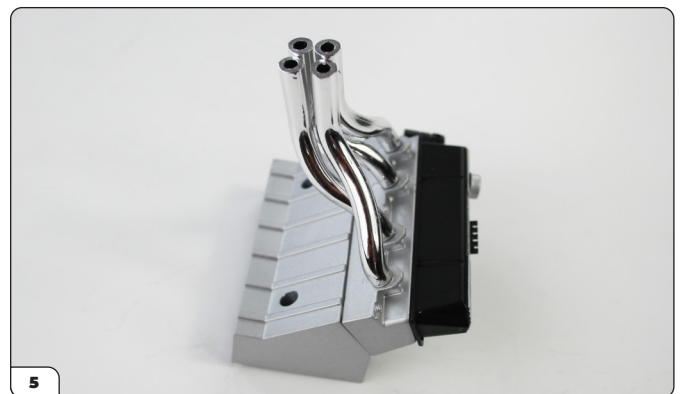
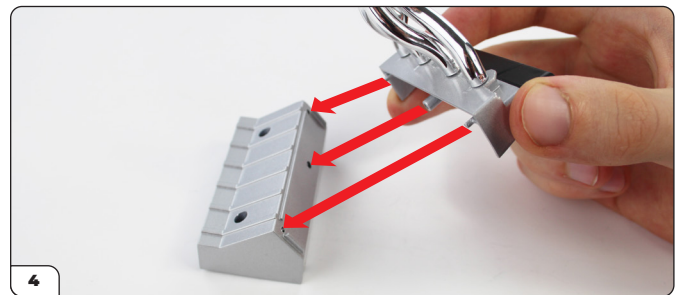
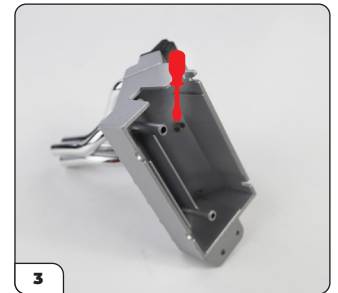
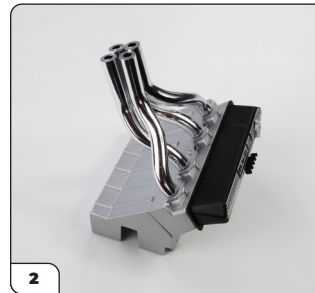
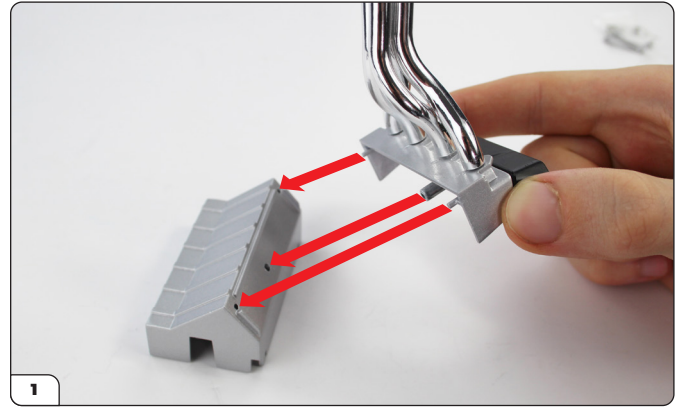

Stage 13: Engine Blocks and Cooling Fluid Tank Bracket

Stage 13 complete!



Stage 14: Flywheel Cover, Gearbox, Inspection Cover, Gearbox Rods

In stage 14 you will add gearbox components to the engine.

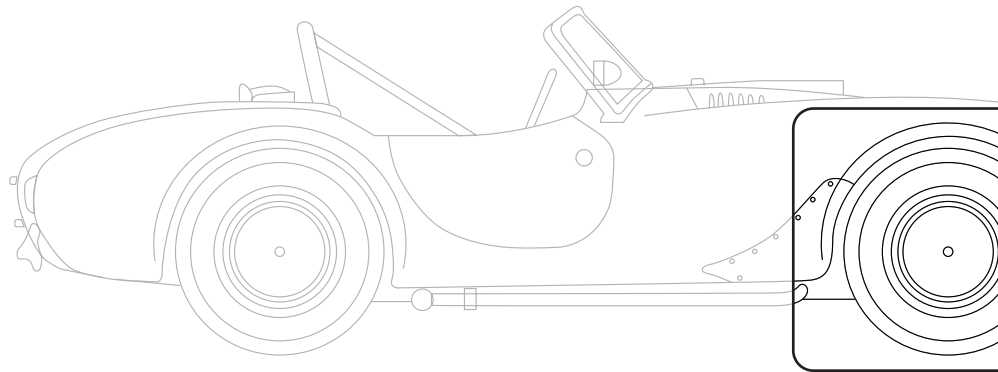

STAGE 14 PARTS LIST

Name	Quantity
Left Flywheel Cover Left	1
Right Flywheel Cover Right	1
Left Gear Box	1
Right Gear Box	1
Gearbox Inspection Cover	1
Gearbox Rod 1	1
Gearbox Rod 2	1
Gearbox Rod 3	1
Gearbox Rod 3 Bracket	1
Screws TYPE OD03	7 [including 1 spare]
Screws TYPE OP07	3 [including 1 spare]

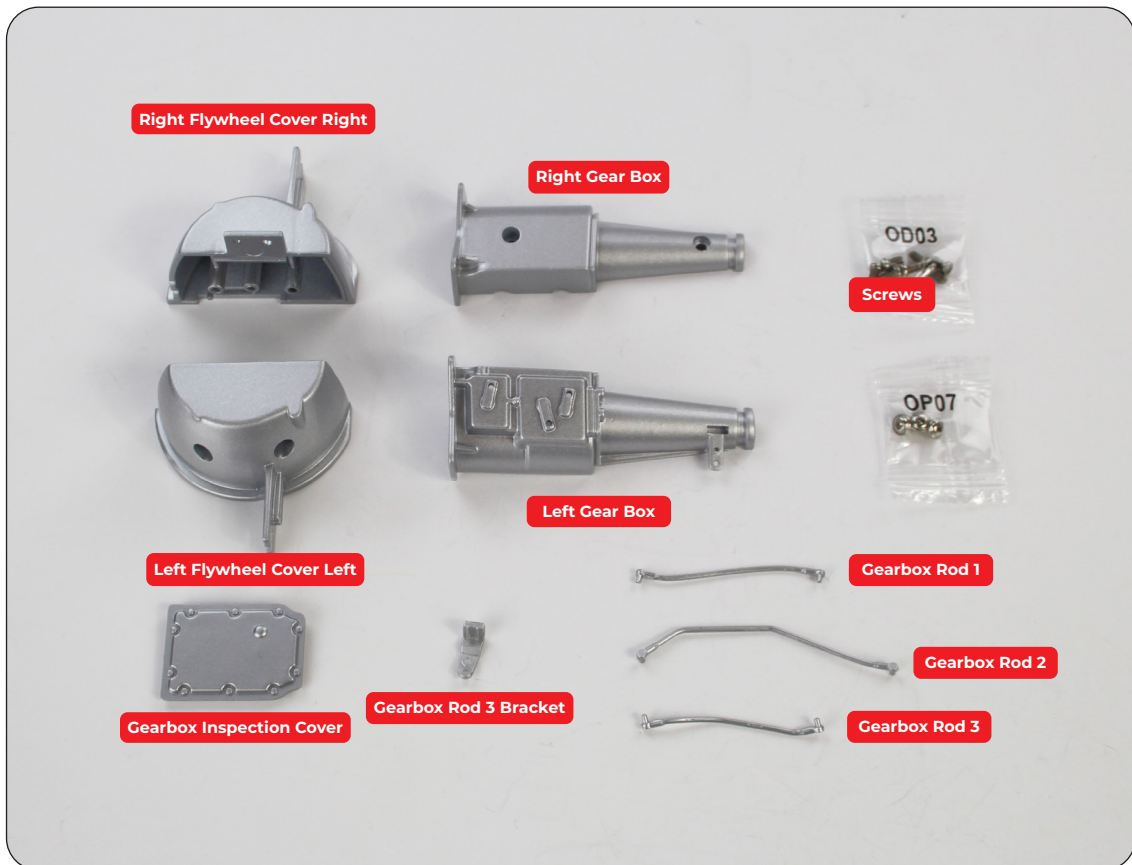

Stage 14: Flywheel Cover, Gearbox, Inspection Cover, Gearbox Rods

STEP 1

ASSEMBLE THE GEARBOX INSPECTION COVER AND FLYWHEEL COVERS

Take the inspection plate and fix 2 x TYPE OP07 screws into the two screw holes. Identify the left and right flywheel covers by the 'L' and 'R' marks on the inside of each part. Then take the right flywheel cover and align the lug and screw hole with the right engine block assembly from the previous stage. Fix in place with a TYPE OD03 screw. Take the left flywheel cover and align the lugs and the holes with the right flywheel cover. Secure the parts together using 2 x TYPE OD03 screws.

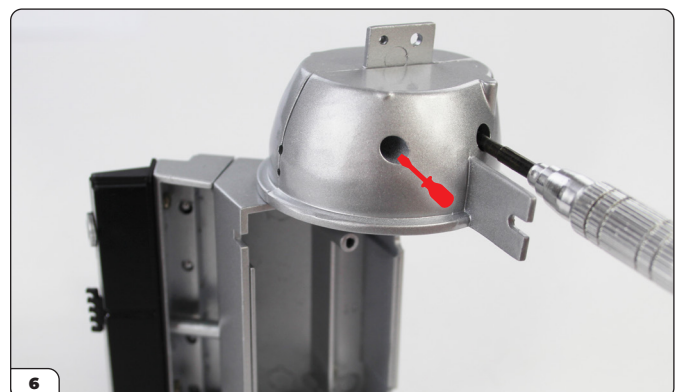
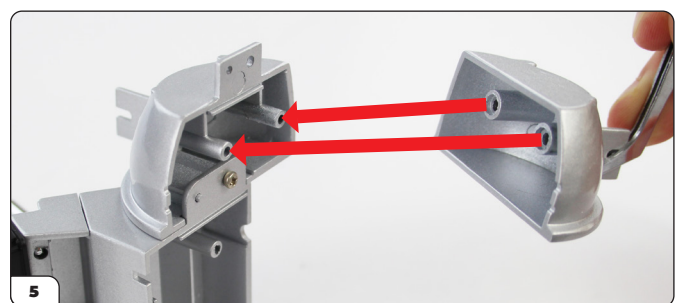
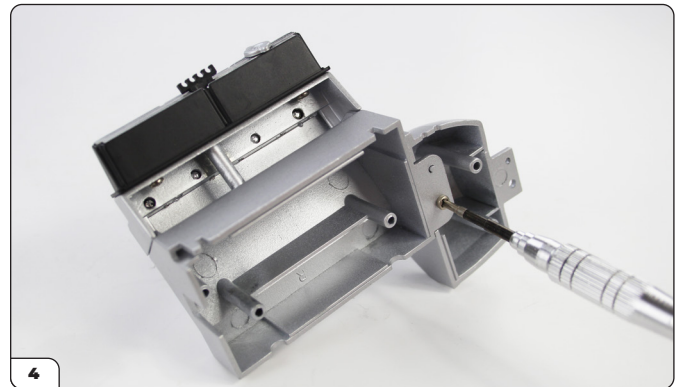
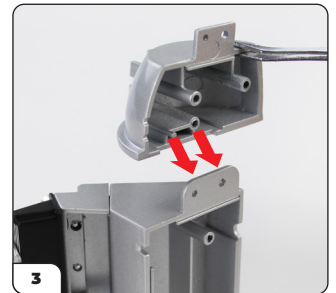
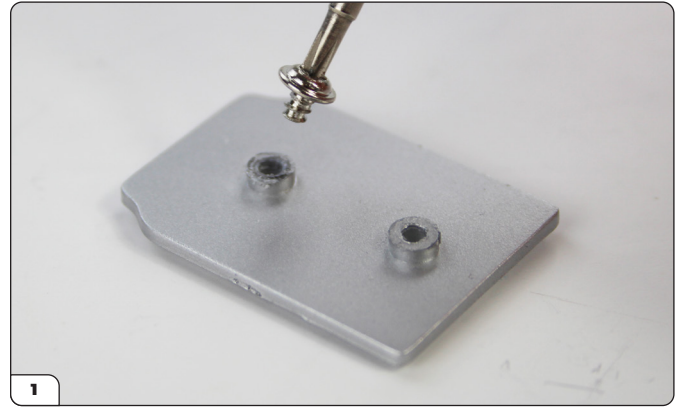

Stage 14: Flywheel Cover, Gearbox, Inspection Cover, Gearbox Rods

STEP 2

ATTACH THE GEARBOX

Mount the right gearbox (indicated by an 'R') and sit it on top of the flywheel parts. Fix in place with a TYPE OD03 screw.

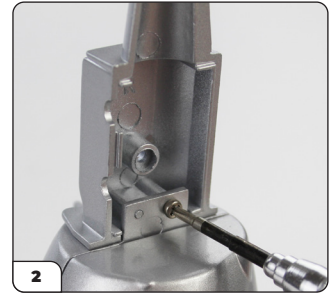
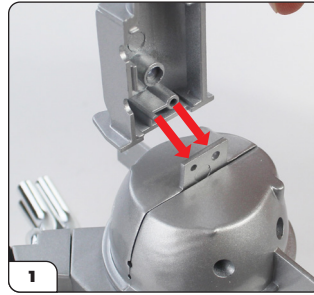

STEP 3

POSITION THE INSPECTION PLATE AND ATTACH THE LEFT GEARBOX

Align the screws on the inspection plate with the notches on the right gearbox. Slide into position. Hold the inspection plate in place while positioning the left gearbox. Secure the parts using 2 x TYPE OD03 screws.

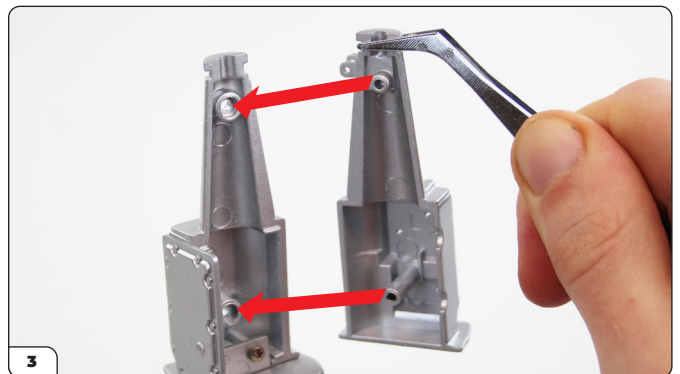
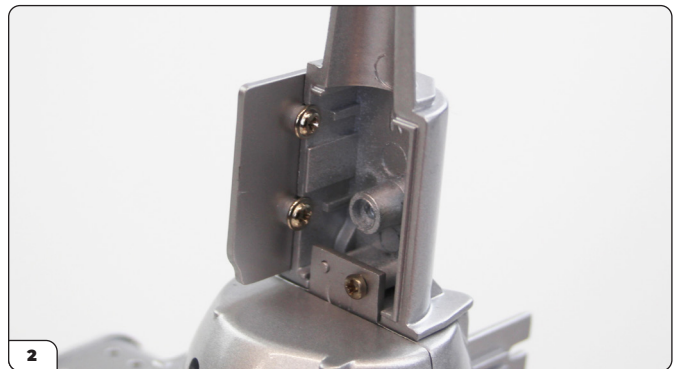
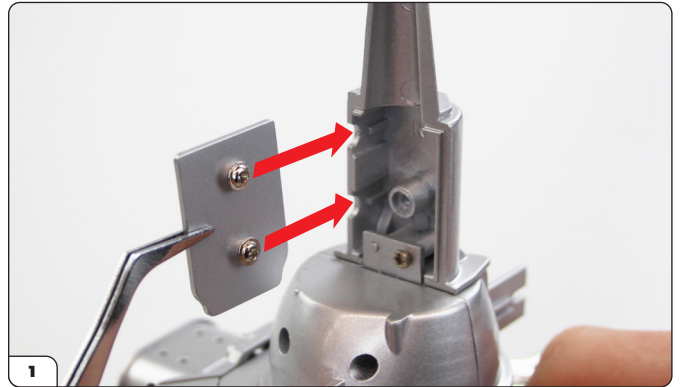

Stage 14: Flywheel Cover, Gearbox, Inspection Cover, Gearbox Rods

STEP 4

ATTACH THE GEARBOX RODS

Identify the gearbox rods 1, 2 and 3. Number 2 is the longest rod, numbers 1 and 3 are identified by the shape of the curve. Please study the parts photos carefully. Take rod no. 3. Place each end of the rod into the tiny holes on the gearbox as indicated. Repeat with rod no. 1 as shown in picture 3. Take the rod no. 3 bracket and push it into the slot on the gearbox, over the two ends of rods 1 and 3. Finally, take rod no. 2 and place one end in the tiny hole in the gearbox, and the other end in the hole on the bracket. It might help to use tweezers to squeeze the rods into the holes.



ADVICE FROM THE EXPERTS

Use a tiny drop of superglue to secure the gearbox rods if they are loose in the holes. This is best applied in the holes with a cocktail stick.

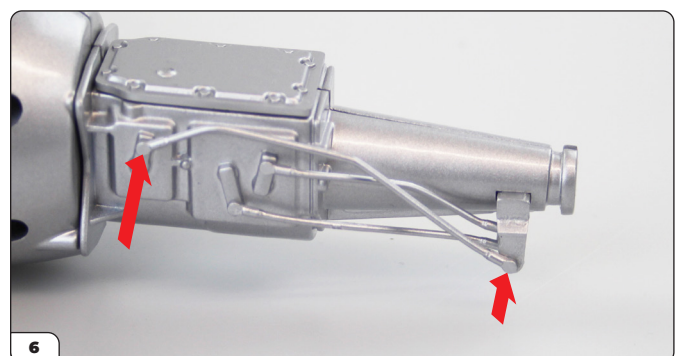
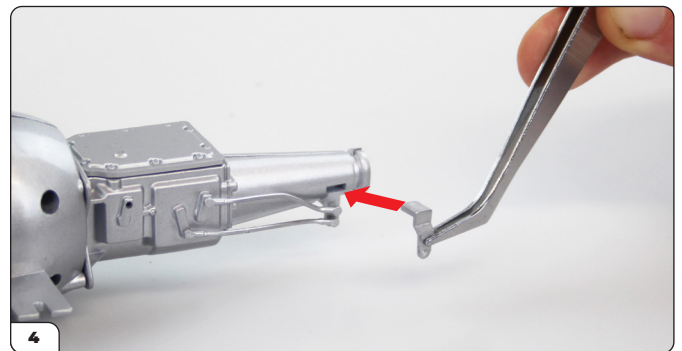
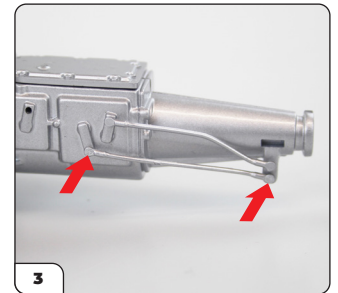
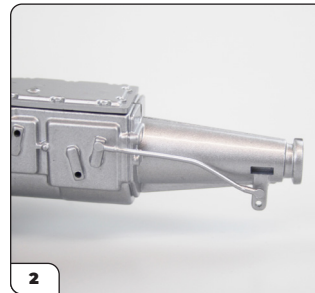
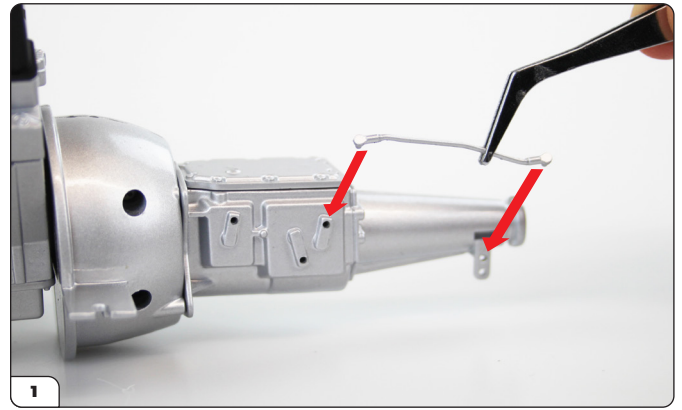

Stage 14: Flywheel Cover, Gearbox, Inspection Cover, Gearbox Rods

Stage 14 complete!

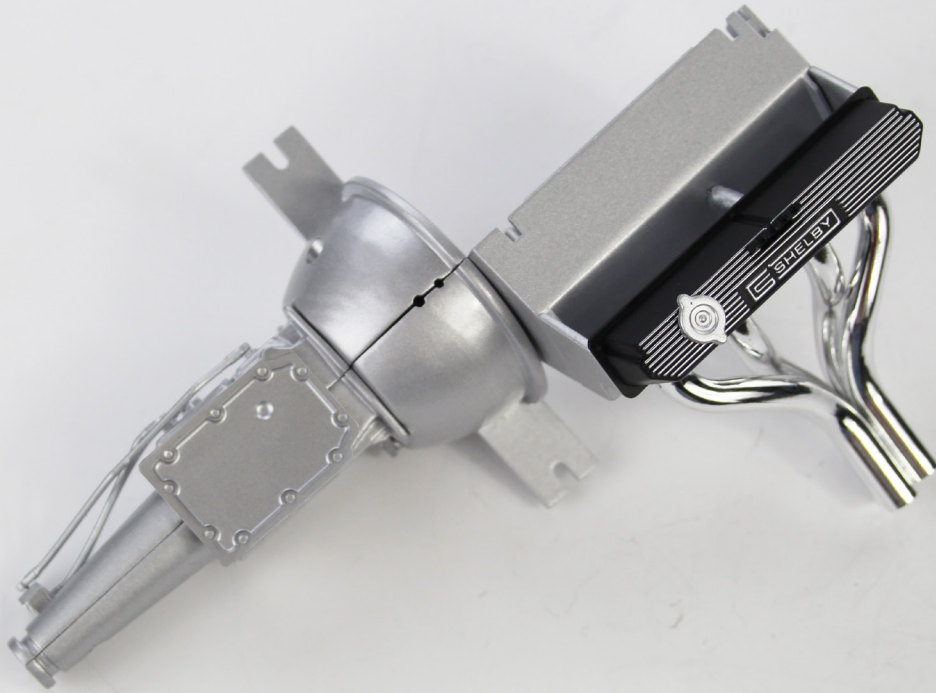

Stage 15: Oil Pan, Protective Plate, Spark Plugs, Spark Plug Wire and Wire Connectors

In stage 15 you will assemble the engine components together and install the spark wires in the correct firing sequence!

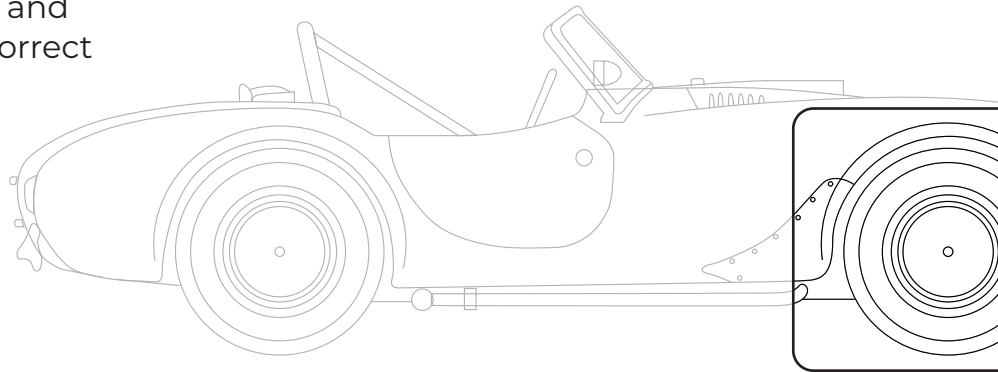

STAGE 15 PARTS LIST

Name	Quantity
Oil Pan	1
Protective Plate	1
Sparkwire Connector	1
Set of Spark Plugs	1 [including 1 spare]
Spark Wire	1
Screws TYPE OP07	3 [including 1 spare]
Screws TYPE OD04	3 [including 1 spare]
Screws TYPE OD03	4 [including 1 spare]
Screws TYPE OP03	3 [including 1 spare]



Stage 15: Oil Pan, Protective Plate, Spark Plugs, Spark Plug Wire and Wire Connectors

STEP 1

ATTACH THE PROTECTIVE PLATE TO THE OIL PAN

Take the oil pan and the protective plate, aligning the lug and holes as shown. Fix together from the underside using 2 x TYPE OP03 screws. Screw 2 x TYPE OP07 screws into the remaining two, raised screw holes on the protective plate.

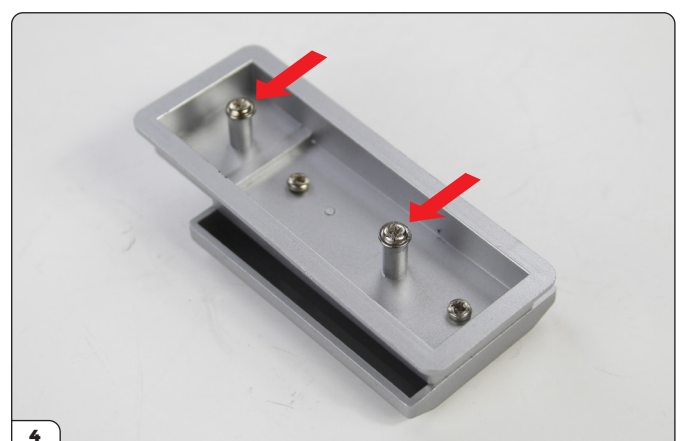
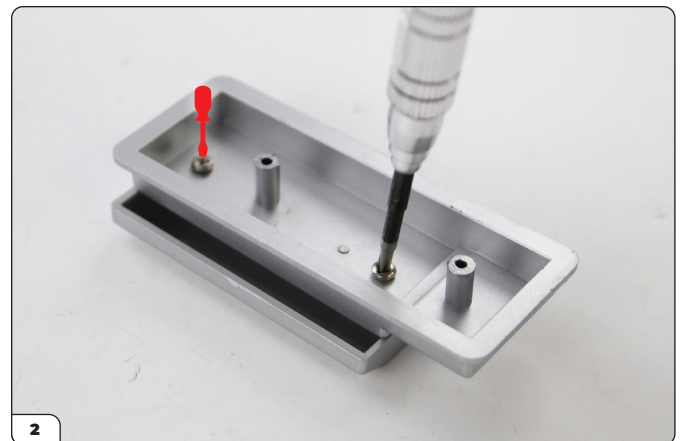

Stage 15: Oil Pan, Protective Plate, Spark Plugs, Spark Plug Wire and Wire Connectors

STEP 2

FIT TWO OD04 SCREWS TO THE ENGINE BLOCK

Take the engine block assembly from stage 12 and screw in 2 x TYPE OD04 screws. Only drive them in as far as they will go. These screws do not hold any parts together but will serve as an anchor in the next step.

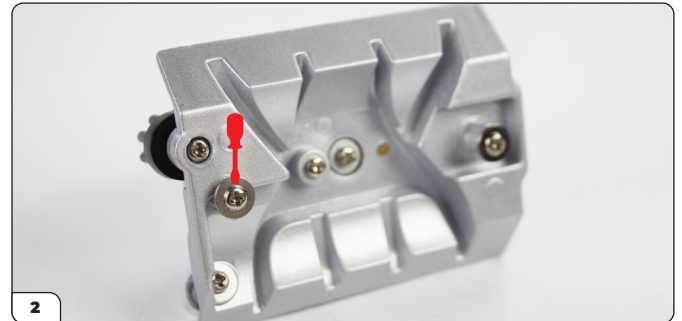
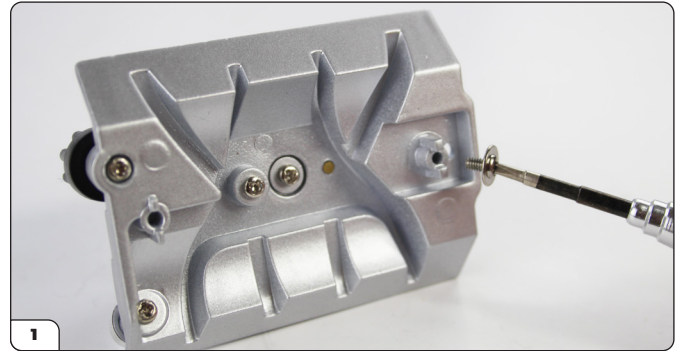

STEP 3

RIGHT ENGINE BLOCK ASSEMBLY

Take the gearbox assembly and slot the cooling fluid tank bracket from stage 13 into position as shown. Position the timing belt assembly from stage 08 onto this gearbox assembly. Secure in place with a TYPE OD03 screw.

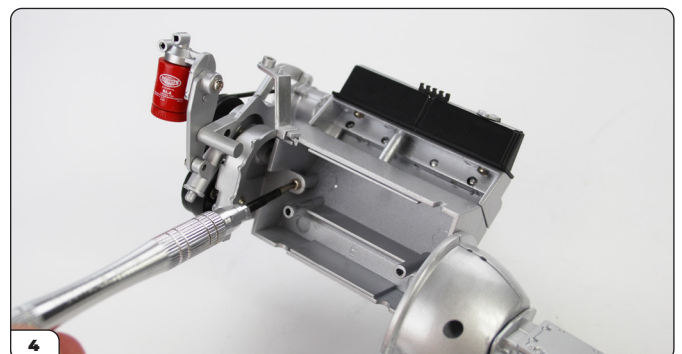
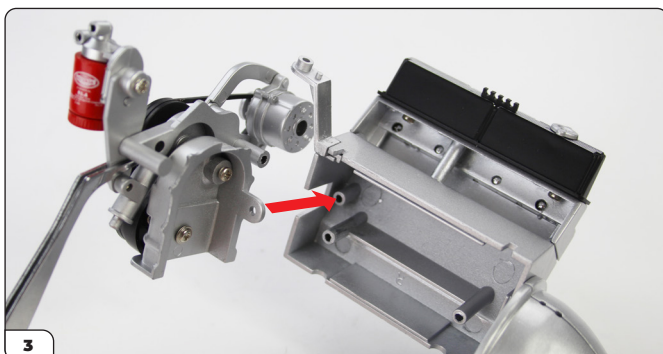
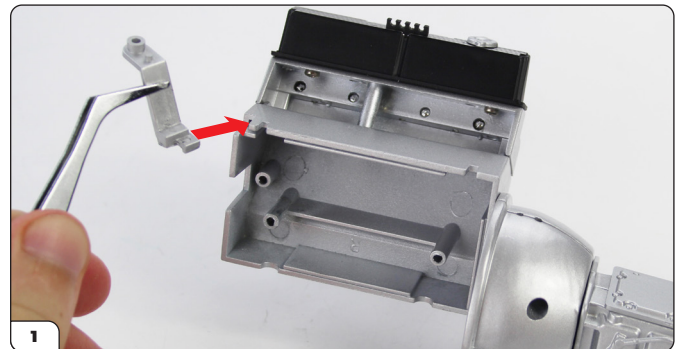

Stage 15: Oil Pan, Protective Plate, Spark Plugs, Spark Plug Wire and Wire Connectors

STEP 4

ATTACH THE PROTECTIVE PLATE

Take the oil pan and protective plate assembly and slide the projecting screw heads between the channels on the engine block. If necessary, try loosening the two screws so the oil pan assembly slides into the channels easily

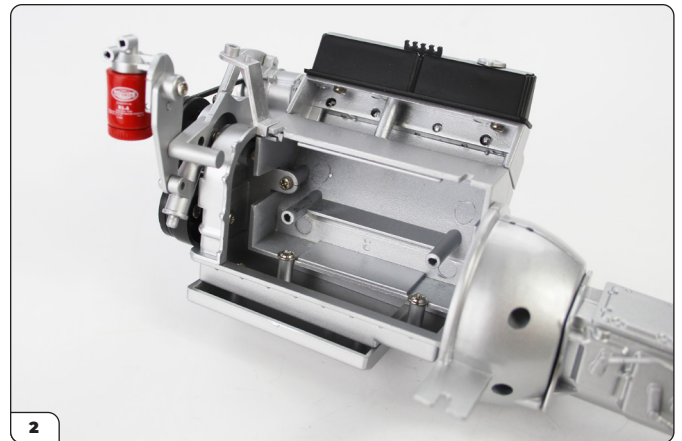
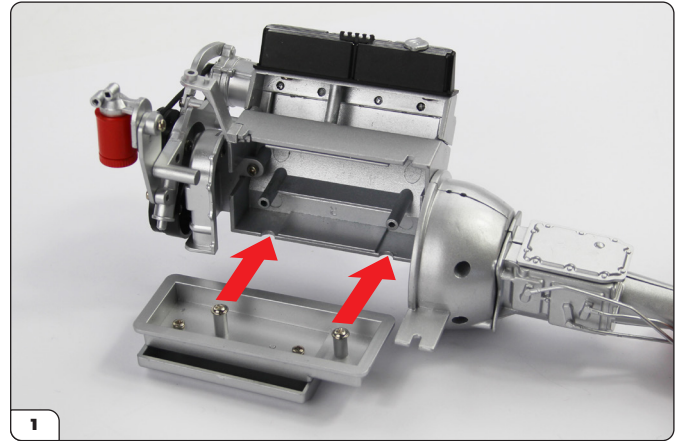

STEP 5

ATTACH THE ENGINE BLOCK

Take the engine block assembly from step 2 and align it with the gearbox assembly. Slide the projecting screw heads between the channels.

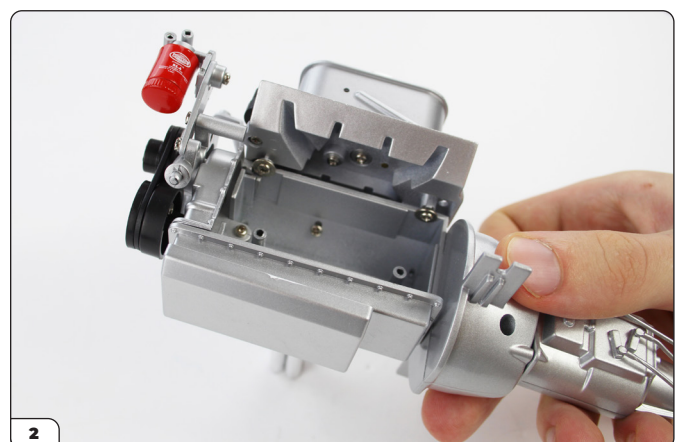
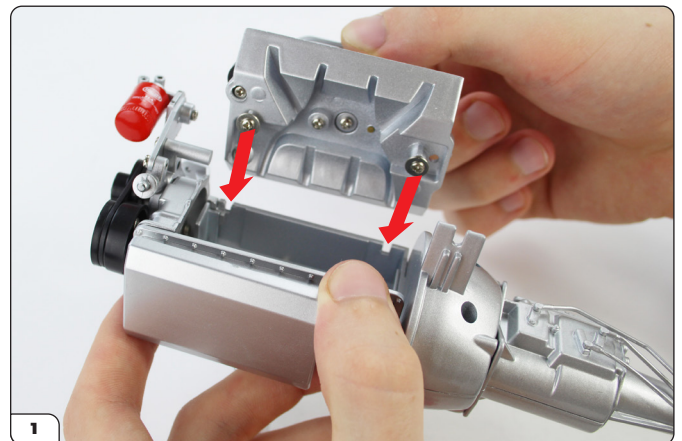

Stage 15: Oil Pan, Protective Plate, Spark Plugs, Spark Plug Wire and Wire Connectors

STEP 6

ATTACH THE LEFT ENGINE BLOCK

Take the left engine block and cylinder head assembly and slide it over the screw heads to hold everything in position. Secure in place with 2 x TYPE ODO3 screws. It may help to squeeze the side sections together to align everything to help the final screws go in smoothly



ADVICE FROM THE EXPERTS

Check that the cylinder head and sump are held firmly before screwing the engine block together. Loosen or tighten the screws in steps 4 and 5 so that the engine block goes together easily, but the head and oil pan aren't loose.

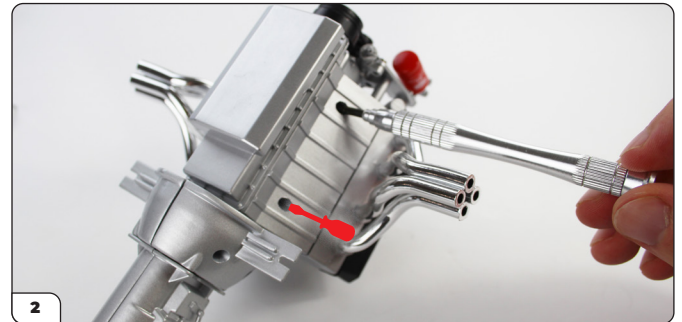
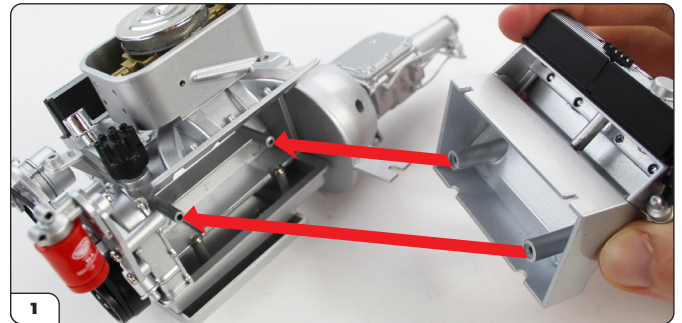

STEP 7

POSITION THE SPARK PLUGS

Identify the spark plugs and the spark wire connectors – the spark plugs are longer. Separate the spark plugs by twisting them off the strip, or cutting with a blade. Using tweezers, push the thin end of four spark plugs into the four holes between the exhaust pipes, until they click into place. Repeat with another four spark plugs on the opposite side.



Stage 15: Oil Pan, Protective Plate, Spark Plugs, Spark Plug Wire and Wire Connectors

STEP 8

FIT THE SPARK WIRE AND CONNECTORS

Remove the spark wire connectors from their strip, twisting or using a blade. Then take a ruler and measure and cut nine lengths of spark wire as follows:

Position 4: 1 x 8 cm

Position 8: 1 x 6.5 cm

Position 3: 1 x 8 cm

Position 7: 1 x 6.5 cm

Position 2: 1 x 7.5 cm

Position 6: 1 x 7.5 cm

Position 1: 1 x 8 cm

Position 5: 1 x 6.5 cm

Plus 1 x 2.5 cm

Take each length of wire and push one end of each length into a spark plug connector, using a twisting motion.

Take each length of wire and push the spark wire connector into the distributor and the free end into a spark plug, in the corresponding positions as indicated on the diagram below. Press each wire into place on the spark wire holder.

The connector pins and holes in the distributor are D shaped to ensure they are angled correctly. It may be easier to connect the wire to the spark plug first, and then the distributor. Either way is fine.

! **ADVICE FROM THE EXPERTS**
Don't worry if the connectors seem loose in the distributor. They should all hold nicely once they are all in place. Only glue them in as a last resort, using a tiny drop of superglue.

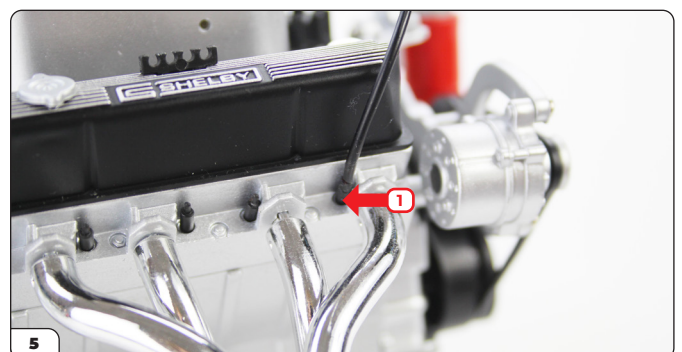
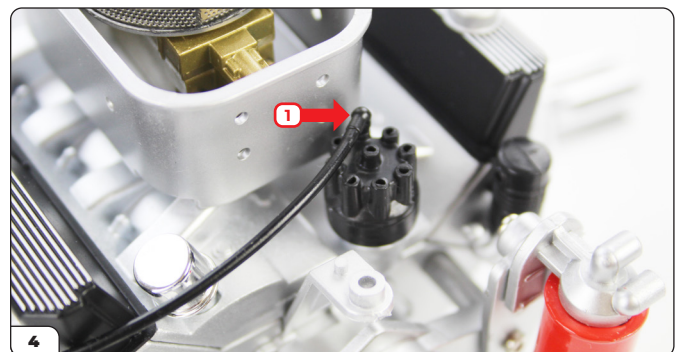

KEY

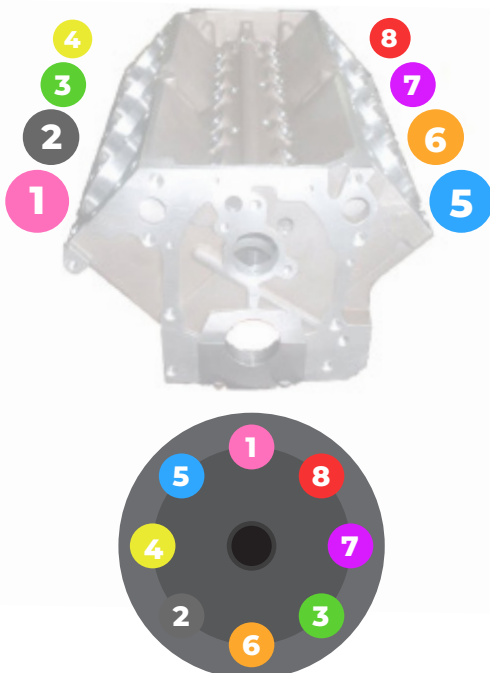

Stage 15: Oil Pan, Protective Plate, Spark Plugs, Spark Plug Wire and Wire Connectors

STEP 8

THE FOLLOWING PICTURES SHOW THE SPARK WIRES BEING CONNECTED IN THE CORRECT SEQUENCE, FROM 1 TO 8.

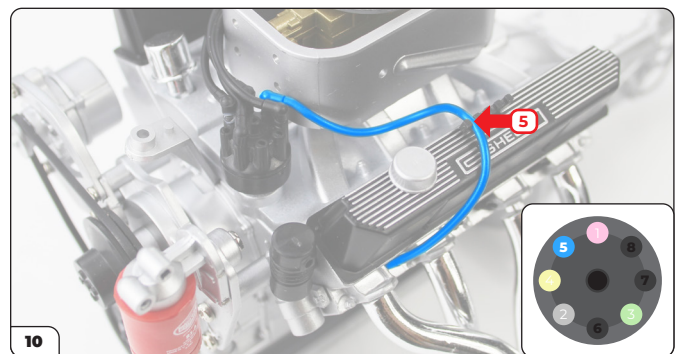
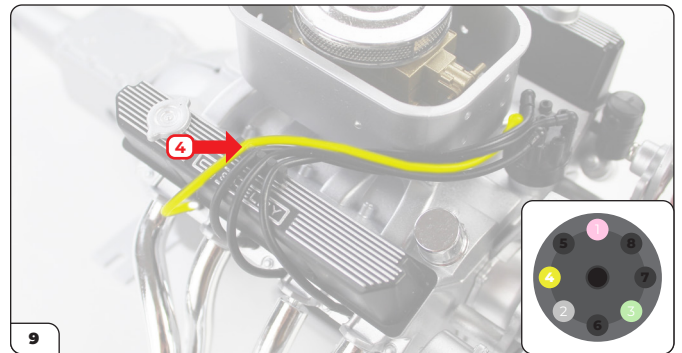
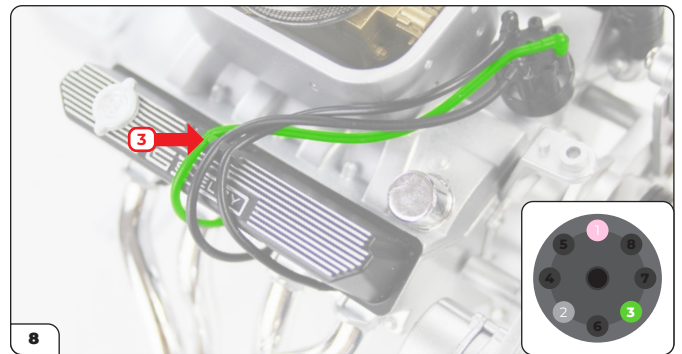
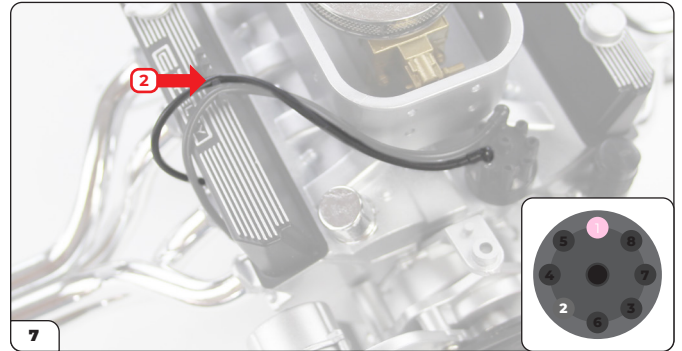
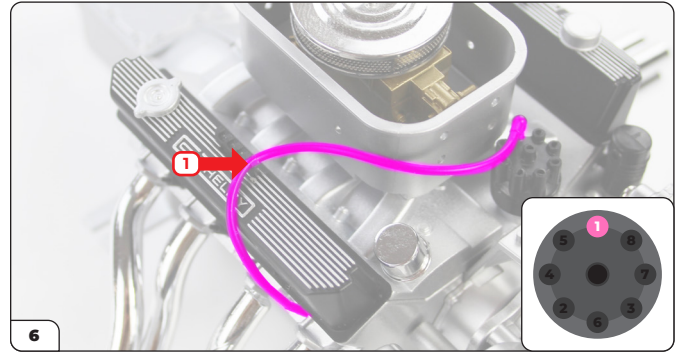

KEY

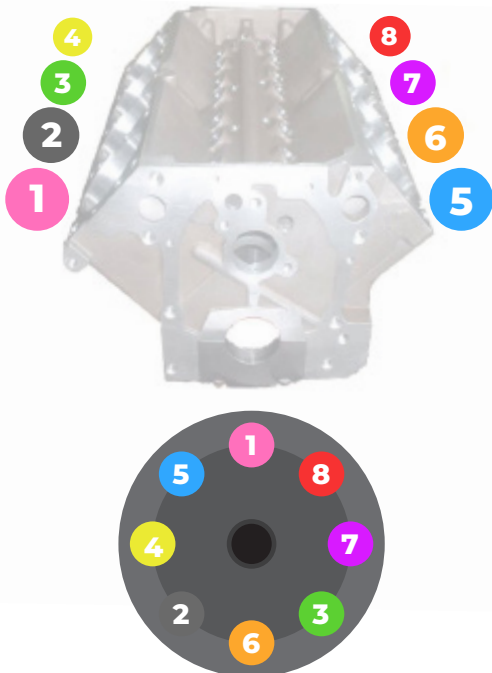

Stage 15: Oil Pan, Protective Plate, Spark Plugs, Spark Plug Wire and Wire Connectors

STEP 8

CONTINUED....

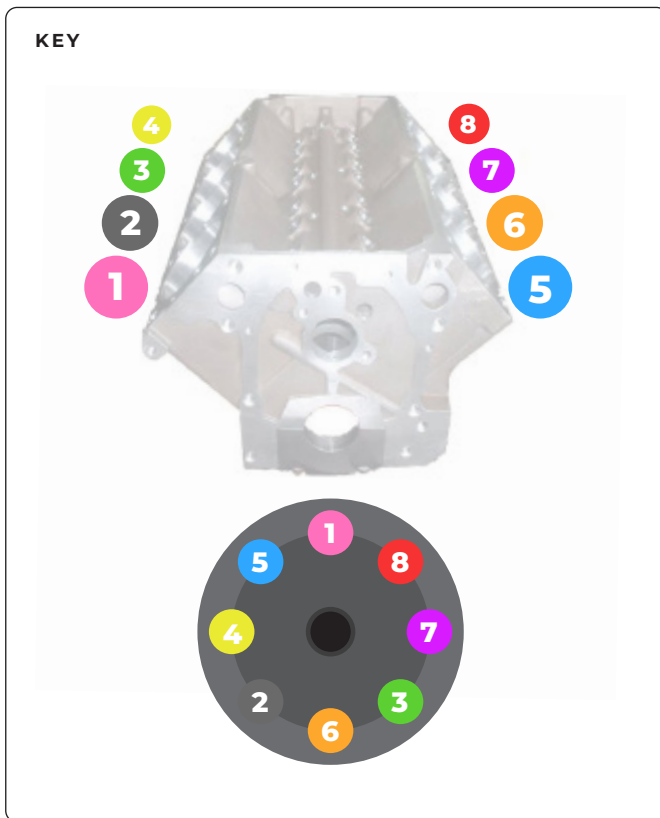
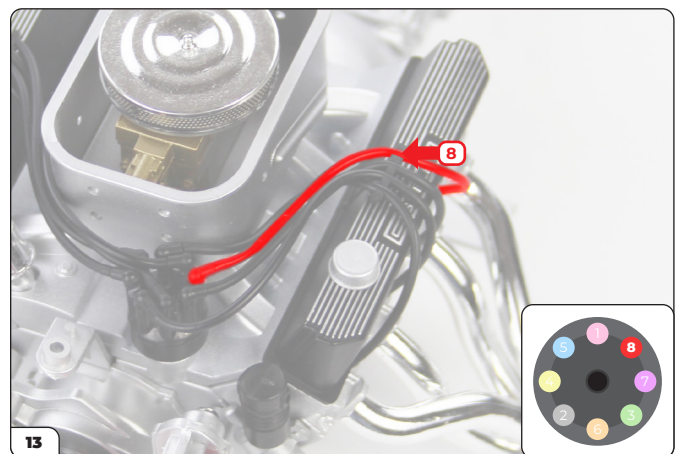
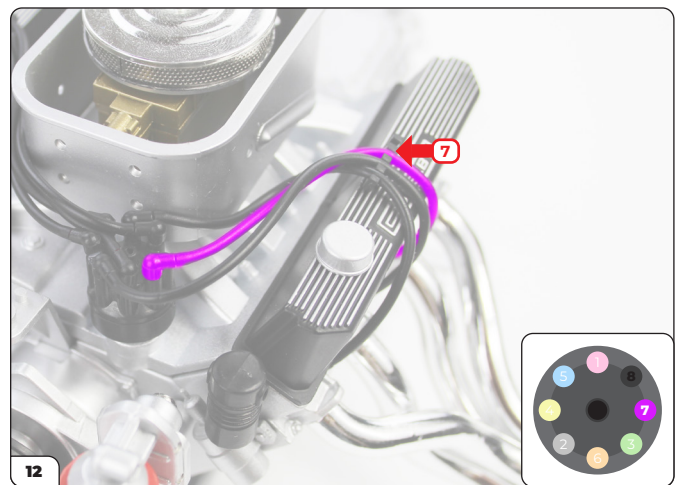
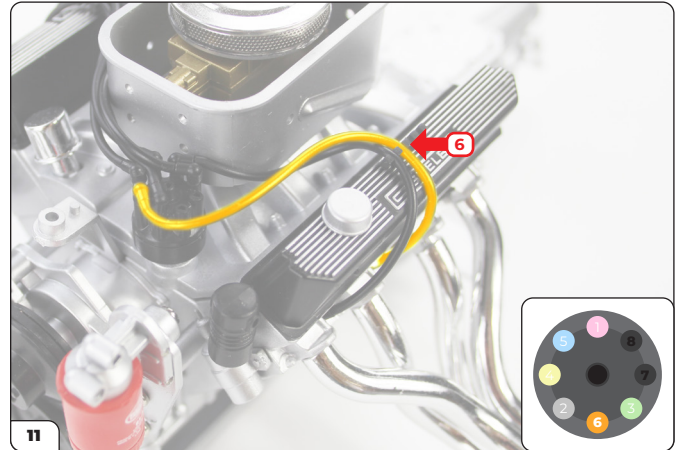

STEP 9

CONNECT THE SPARK WIRE TO THE IGNITION COIL

Finally position the 2.5cm length of wire as shown in picture 1.

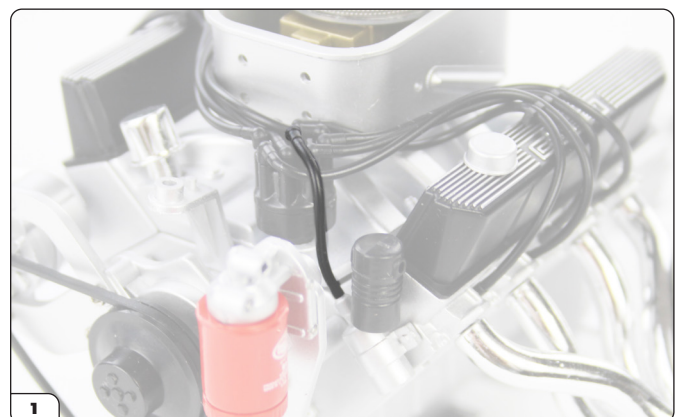

Stage 15: Oil Pan, Protective Plate, Spark Plugs, Spark Plug Wire and Wire Connectors

Stage 15 complete!

