



# FDNY®

## FIRE TRUCK TOWER LADDER 9



# Pack 01

## BUILD INSTRUCTIONS

**STAGE 01: REAR LEFT WHEEL, HOSE,  
& NAME PLATE**

**STAGE 02: REAR PANEL AND FRONT RIGHT  
CAB DOOR**

**STAGE 03: FRONT GRILLE & REAR LEFT  
CAB DOOR**

**STAGE 04: FRONT BUMPER, AIR HORN,  
SPEAKER, & SEAT**

**STAGE 05: COMPONENTS FOR THE CAB ROOF**

**STAGE 06: ASSEMBLING THE PLATFORM AND  
REAR AXLE**

**STAGE 07: LEFT-HAND SIDE STORAGE  
COMPARTMENT**

**STAGE 08: HANDY SCREW IDENTIFIER**

# Advice from the experts

---

 **Please keep ALL unused screws as they will be required in a later stage.**

Please make sure you don't mix up the screws. They look quite similar, but the threads do vary slightly. Using the wrong screws may damage the parts.

When securing parts together using multiple screws, fit each screw loosely to ensure all the parts are correctly aligned before gently tightening them firmly, but not overtight, in the order in which you placed them.

The screwdriver can be magnetized by stroking it with a magnet (fridge magnet, etc.) enabling it to hold the screws and make assembly easier.

If a screw is tight going into a metal part, do not force it as you may shear the head off. Remove it and put a tiny smear of Vaseline, soap or light oil on the thread. That will lubricate it and make it easier to drive home.

During the course of this build, you will receive many pieces that you will assemble immediately – following the instructions in the corresponding stage – and other pieces that you should store safely to one side, for use in future assembly stages.

Left and Right! When building your fire truck, the left or right hand side refers to each side as you are sitting in the cab.



**WARNING:** Some parts are assembled using magnets. These magnets can cause serious injury if they are swallowed. Keep away from children. If you suspect a magnet has been swallowed, seek medical help straight away.

# Stage 01: Rear Left Wheel, Hose, & Name Plate

You'll start your first pack by assembling one of the rear wheels and the hose. The hose is rolled up for storage, but you may choose to leave it unwound if you have plans to create a live-rescue diorama!



## STAGE 01 PARTS LIST

Name
Rear tire x2
Ladder name plate
Inner wheel
Outer wheel
Hose pack
Hose nozzle
Hub cap
Hose connector

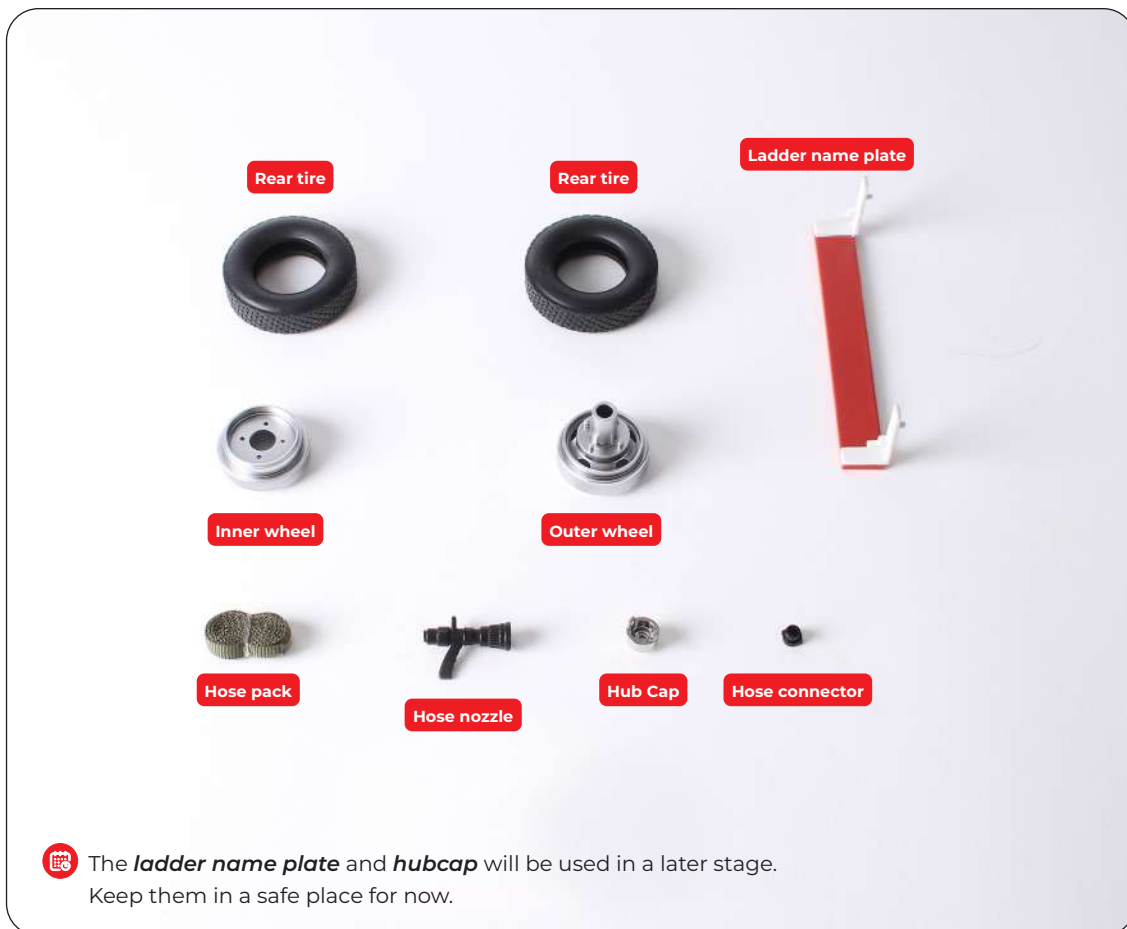

# Stage 01: Rear Left Wheel, Hose, & Name Plate

## STEP 1



### ASSEMBLING THE WHEEL

Push the inner wheel into one of the rear tires so that the tire rim tucks snugly around the groove on the wheel. If the tire is very tight, try soaking it in a hot water bath for one minute.



Push the outer wheel into the remaining tire and tuck the tire rim into the groove around the wheel.

## Stage 01: Rear Left Wheel, Hose, & Name Plate



### FIX THE INNER AND OUTER WHEELS TOGETHER

Apply a drop of glue to the flat surface of the inner wheel as shown.



Take the outer wheel and align the four fixing pins with the holes on the inner wheel before pushing the two wheels together. Press firmly.



The inner and outer wheels have been glued together.

## STEP 2



### ASSEMBLING THE HOSE PACK

Snip any frayed ends off the free end of the hose.



Apply a little superglue to the rim of the nozzle

## Stage 01: Rear Left Wheel, Hose, & Name Plate



Gently open either free end of the hose and fit it over the nozzle. Press firmly until it adheres.



Pinch the other end of the hose to fold it in half. This is going to fit inside the round opening of the connector.



Apply a drop of superglue inside the opening of the connector.



## Stage 01: Rear Left Wheel, Hose, & Name Plate



Push the end of the hose into the connector.



The connector is now fitted. You may choose to leave the hose unravelled...



... or wind it up, ready for storage in one of the tool compartments. Wind tightly around the connector until just a short length remains.



Apply a drop of superglue just before the end to stop the hose unravelling.

# Stage 01: Rear Left Wheel, Hose, & Name Plate



Hosepack complete.

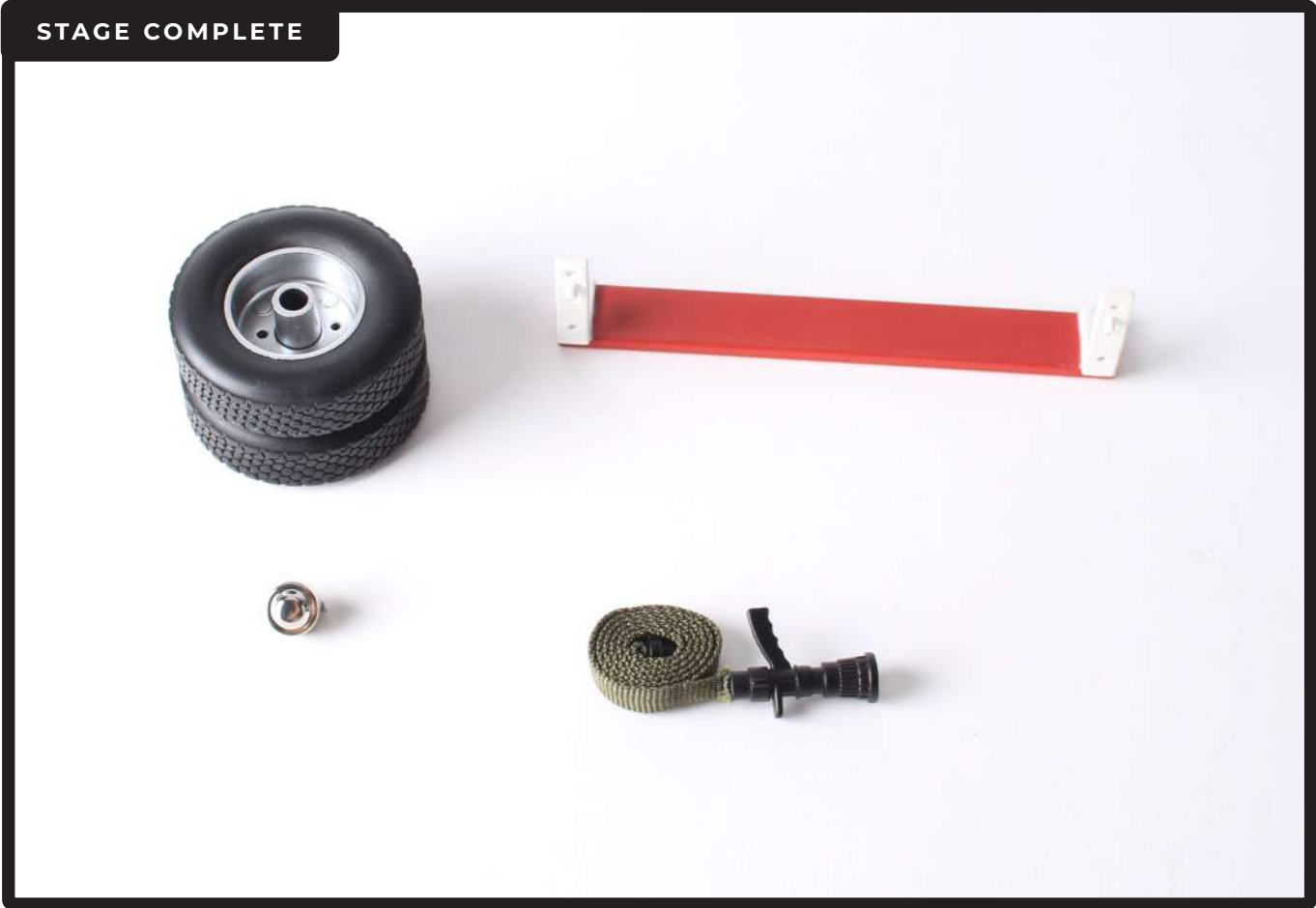



## Stage 02: Rear Panel and Front Right Cab Door

You'll now start to assemble the fire truck rear panel and front right cab door.



### STAGE 02 PARTS LIST

Name
Outer door panel
Inner door panel
Fire truck rear panel
Inner cab panel
Outer door handle
Window winder
Tow hooks x2
Gear

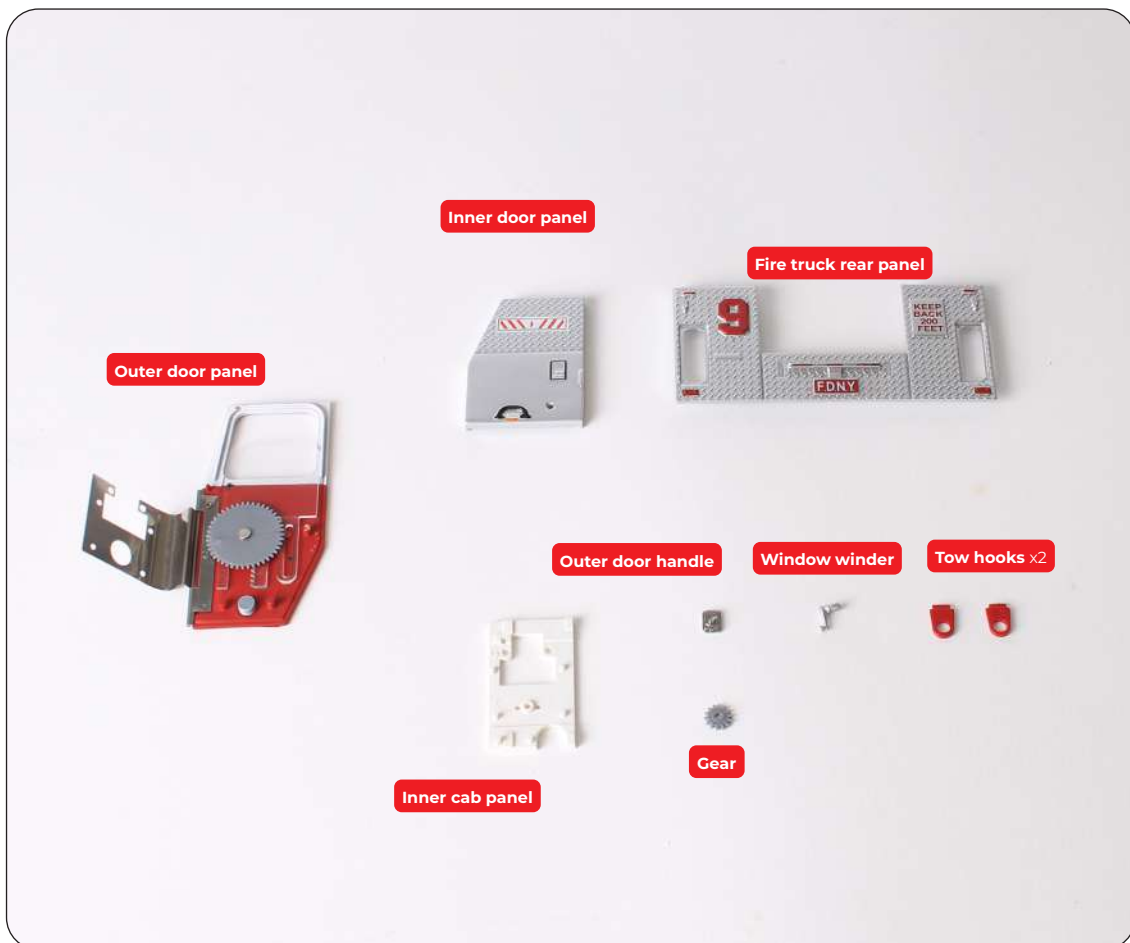

# Stage 02: Rear Panel and Front Right Cab Door

## STEP 1

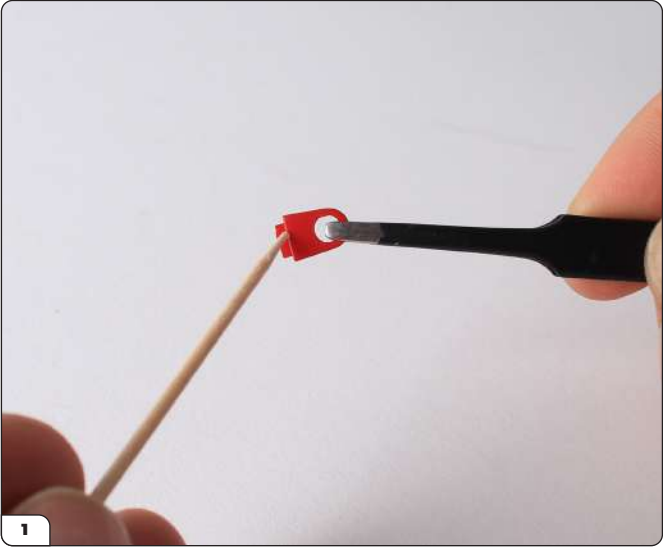

### FIXING THE TOW HOOKS

Apply a little superglue to the tab on one of the two tow hooks.

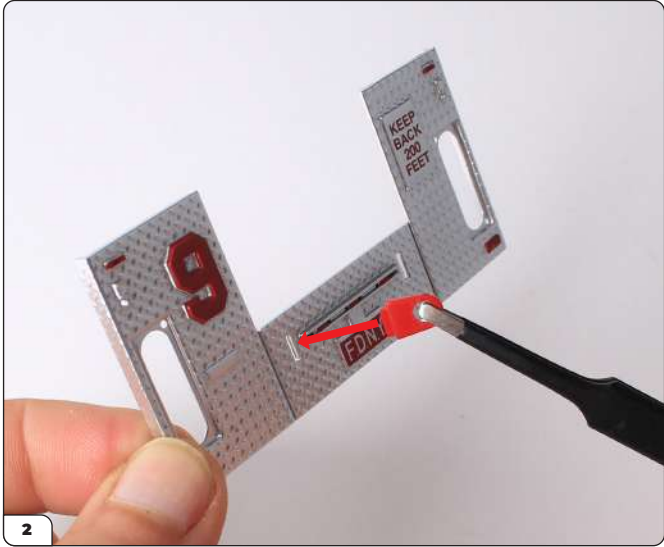

Push the tab into the slot in the fire truck rear panel.

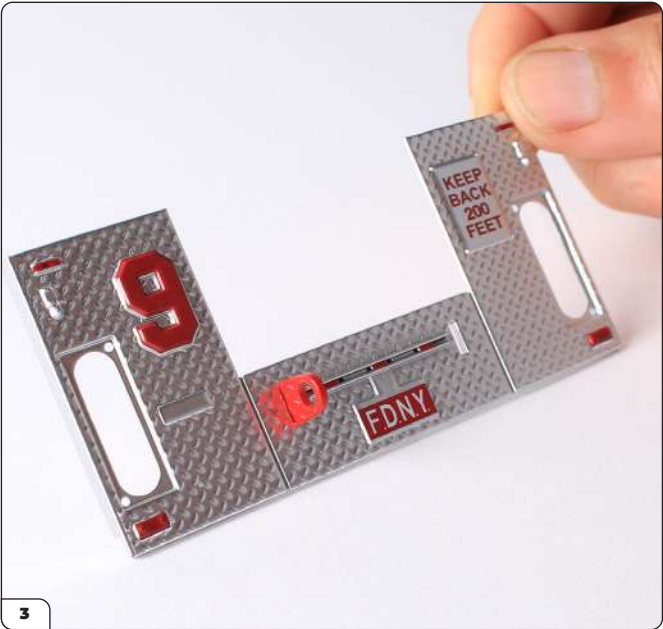

The left tow hook is now fitted

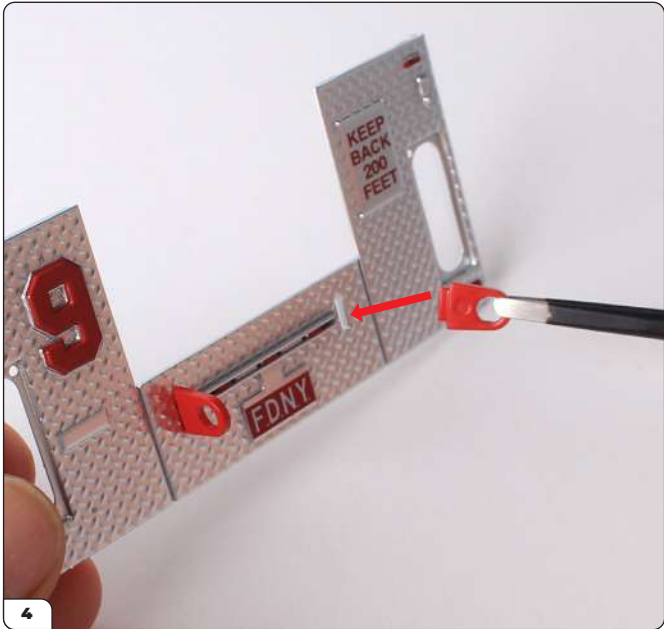

Repeat on the right side to fit the right tow hook.

## Stage 02: Rear Panel and Front Right Cab Door

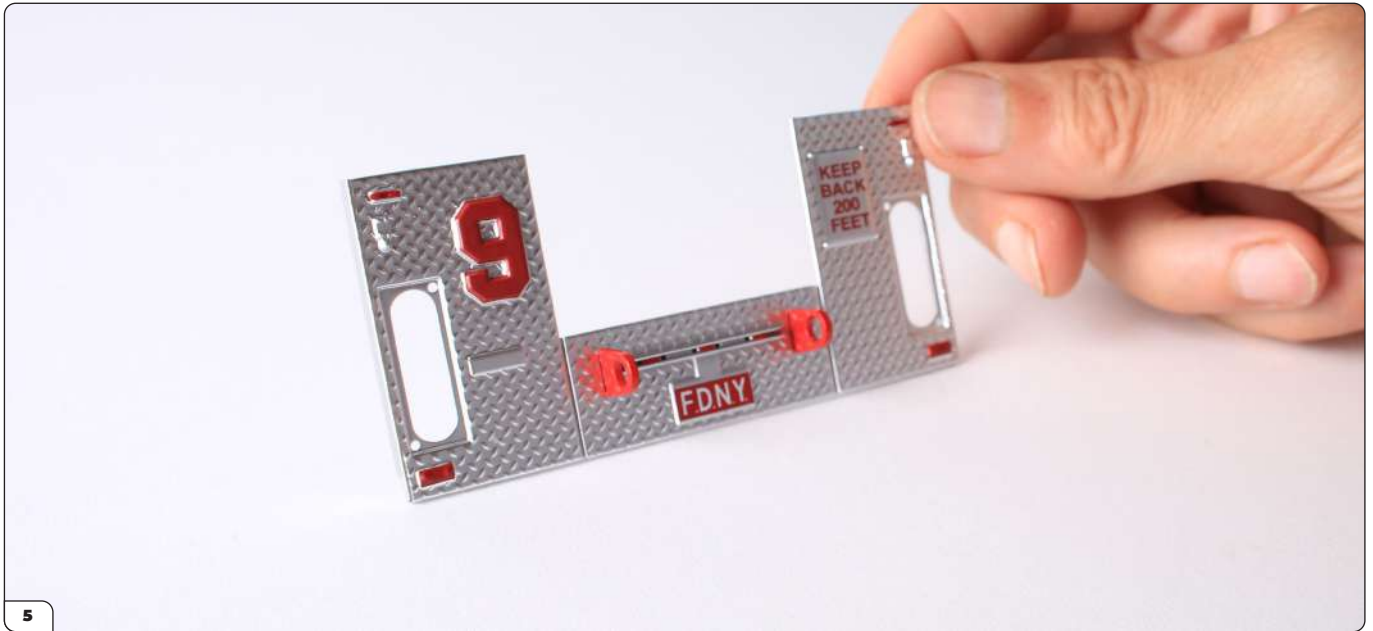

Both tow hooks are now fitted to the rear panel.

### STEP 2



#### ASSEMBLING THE DOOR

Push the handle into the hole in the inner door panel. Press firmly until you feel it click into place.

## Stage 02: Rear Panel and Front Right Cab Door

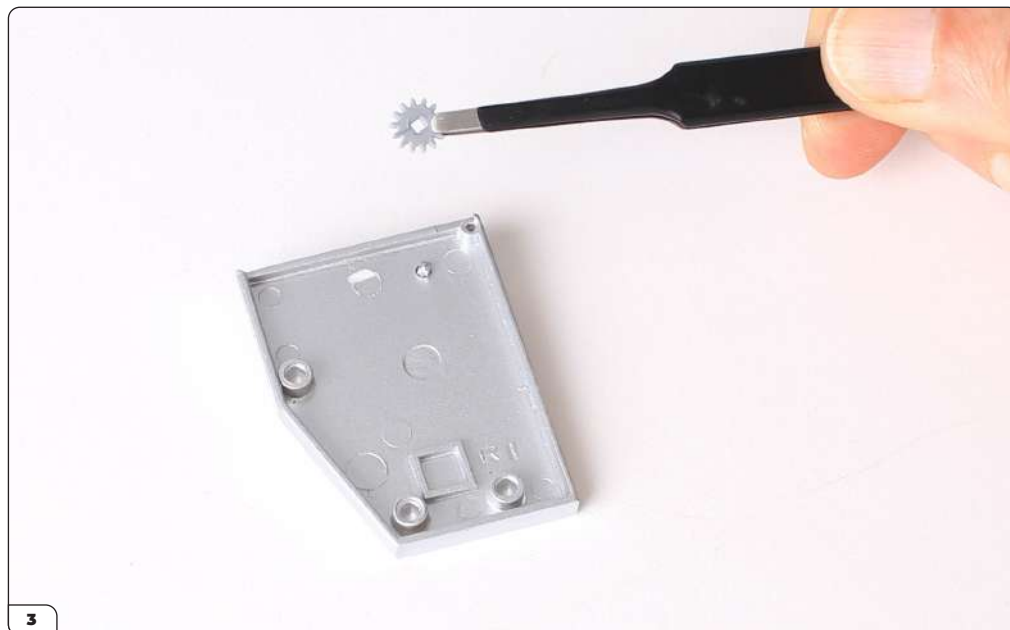

Check that you have the gear the correct way up – the flattest side faces up. Push it onto the square peg on the inside of the inner door panel.



The gear has been correctly fitted.



Apply a drop of superglue to each of the three peg holes and the tiny pin in the top right hand corner, as indicated (circled).

## Stage 02: Rear Panel and Front Right Cab Door

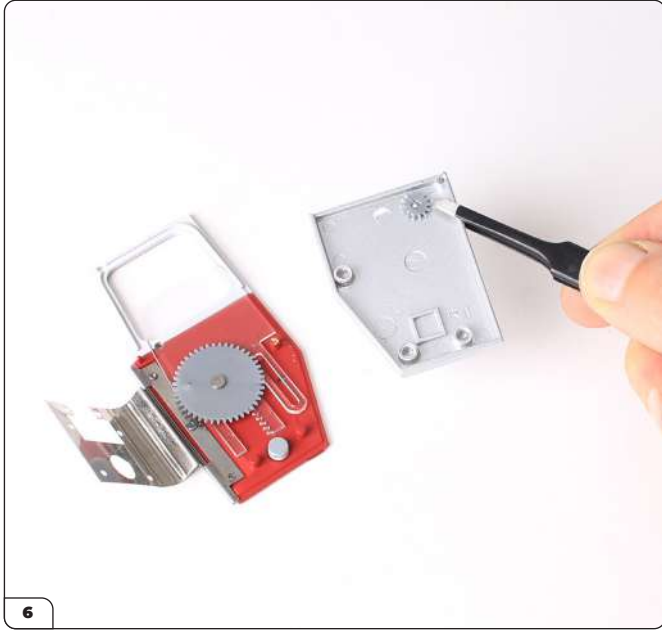

Align the three peg holes on the inner door panel with the three pegs of the inner side of the outer door panel before pressing the parts firmly together.



The inner door panel has been fixed to the outer door panel.

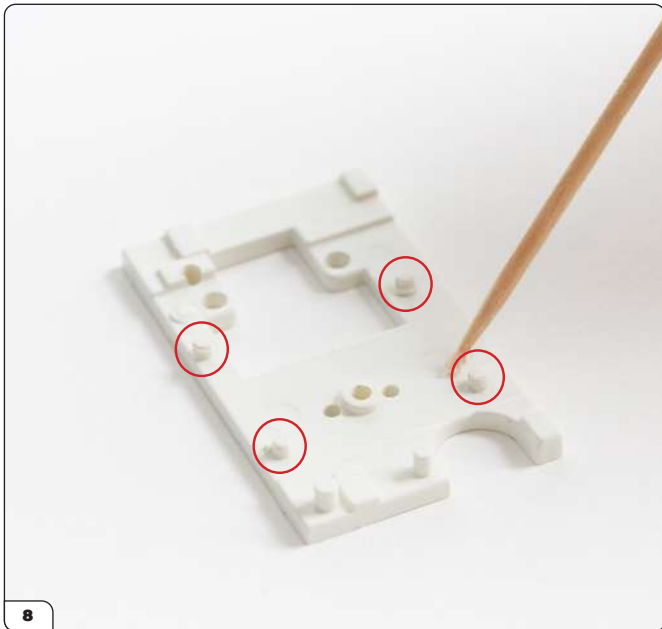

Take the inner cab panel and note that there are four fixing pins. It might be easier if you test fit the parts, then glue the raised areas that will sit underneath the hinge.

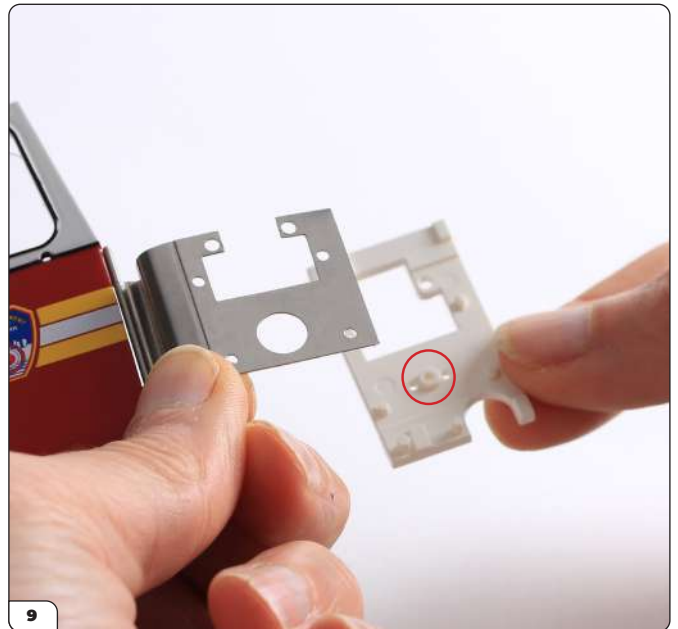

Align the four holes on the door hinge with the four pins on the inner cab panel. Check that the raised screw hole (circled in red above) is positioned centrally in the corresponding hole in the hinge.



## Stage 02: Rear Panel and Front Right Cab Door



Firmly press the hinge into place.



Apply a drop of superglue to the recess for the door handle before pressing the handle into position. This is a D-shaped fitting to ensure the correct fit.



The handle has now been fitted.





## Stage 03: Front Grille & Rear Left Cab Door

In this next stage, you'll assemble the Seagrave logo on the front grille, and the rear left cab door.



### STAGE 03 PARTS LIST

Name
Outer door panel
Inner door panel
Inner cab panel
Front grille
Seagrave logo
Window winder
Rear grille
Gear
Outer door handle



## Stage 03: Front Grille & Rear Left Cab Door

### STEP 1

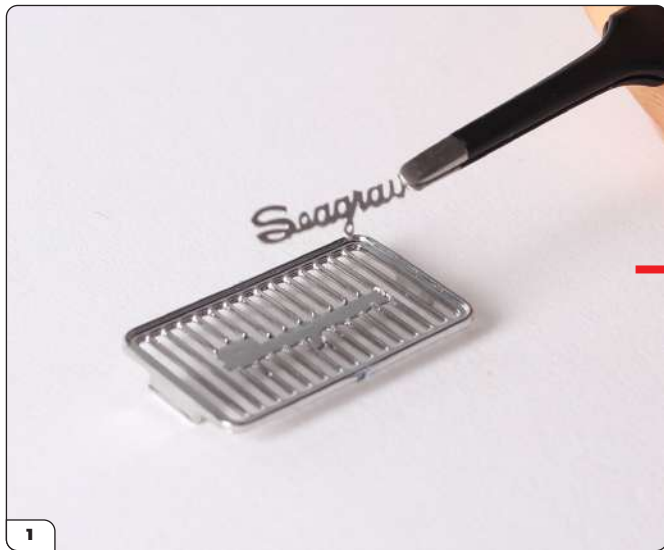

#### ASSEMBLING THE GRILLE

Apply a few tiny drops of superglue to the back of the Seagrave logo, then attach it to the front grille.

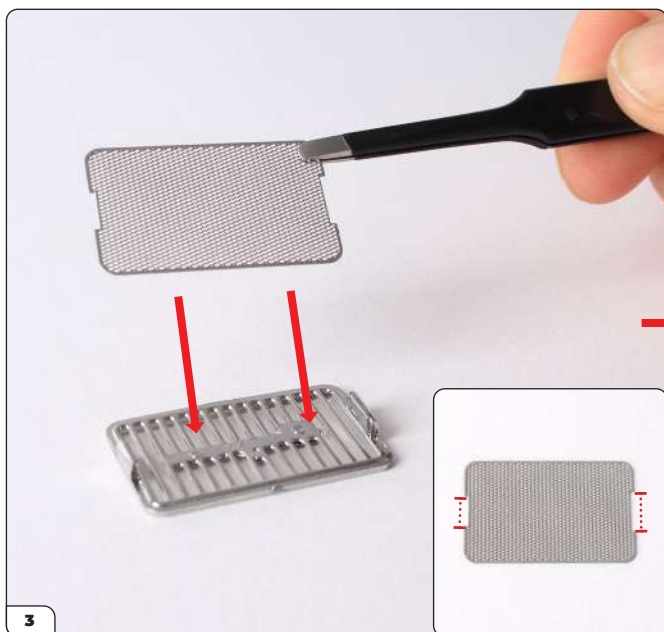

Align the notches on the side of the rear grille with the clips on the front grille. Note: the notches are different sizes to ensure the correct fit.

## Stage 03: Front Grille & Rear Left Cab Door

### STEP 2



#### ASSEMBLING THE DOOR

Push the handle into the hole in the inner door panel. Press firmly until you feel it click into place.

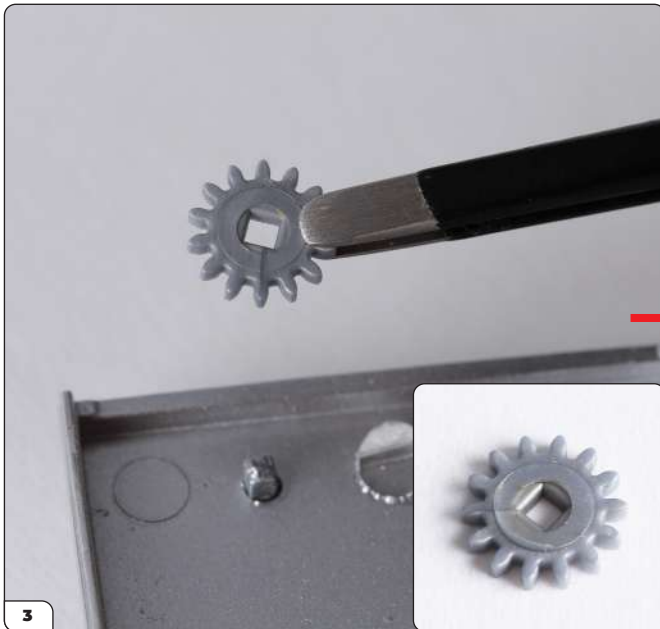

Check that you have the gear the correct way up – the flattest side faces up. Push it onto the square peg on the inside of the inner door panel.

## Stage 03: Front Grille & Rear Left Cab Door

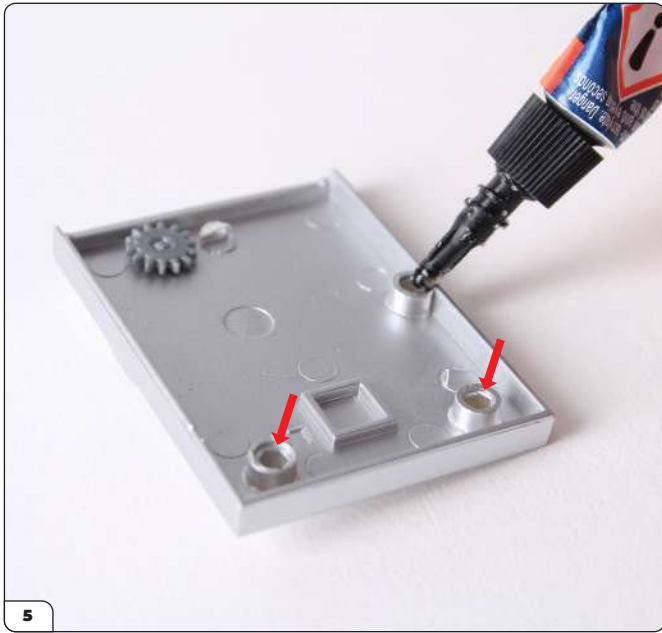

5 Apply a drop of superglue to each of the three peg holes as indicated (arrows).

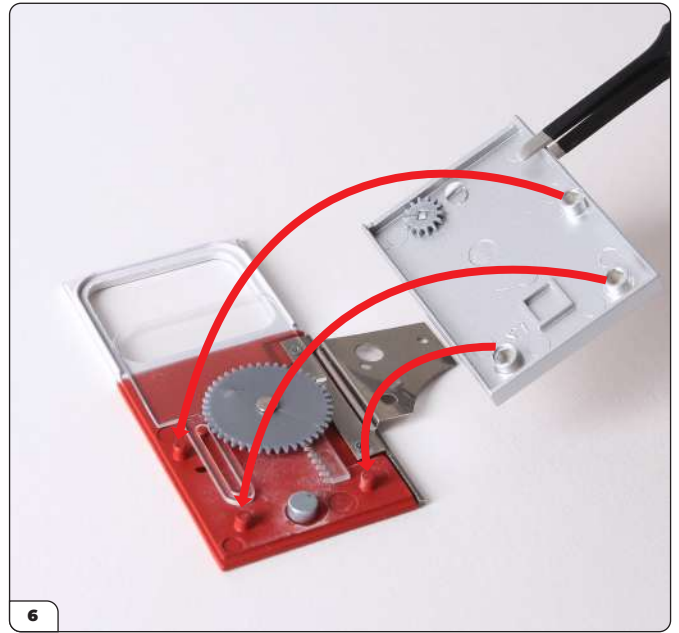

6 Align the three peg holes on the inner door panel with the three pegs of the inner side of the outer door panel.



7 The inner door panel has been fixed to the outer door panel.



8 Take the inner cab panel and glue the raised areas that will sit underneath the hinge. It might be easier if you test fit the parts before gluing (also see pictures 9 & 10).

## Stage 03: Front Grille & Rear Left Cab Door



Align the four holes on the door hinge with the three pins and raised hole on the inner cab panel.



Firmly press the hinge into place.



Apply a drop of superglue to the recess for the door handle before pressing the handle into position. This is a D-shaped fitting to ensure the correct fit.





# Stage 03: Front Grille & Rear Left Cab Door





## Stage 04: Front Bumper, Air Horn, Speaker, & Seat

Now you'll fix the speaker and air horn to the front bumper of your fire truck, and assemble a seat.



### STAGE 04 PARTS LIST

Name
Front bumper
Seat
Seat support
Speaker
Air horn
LED

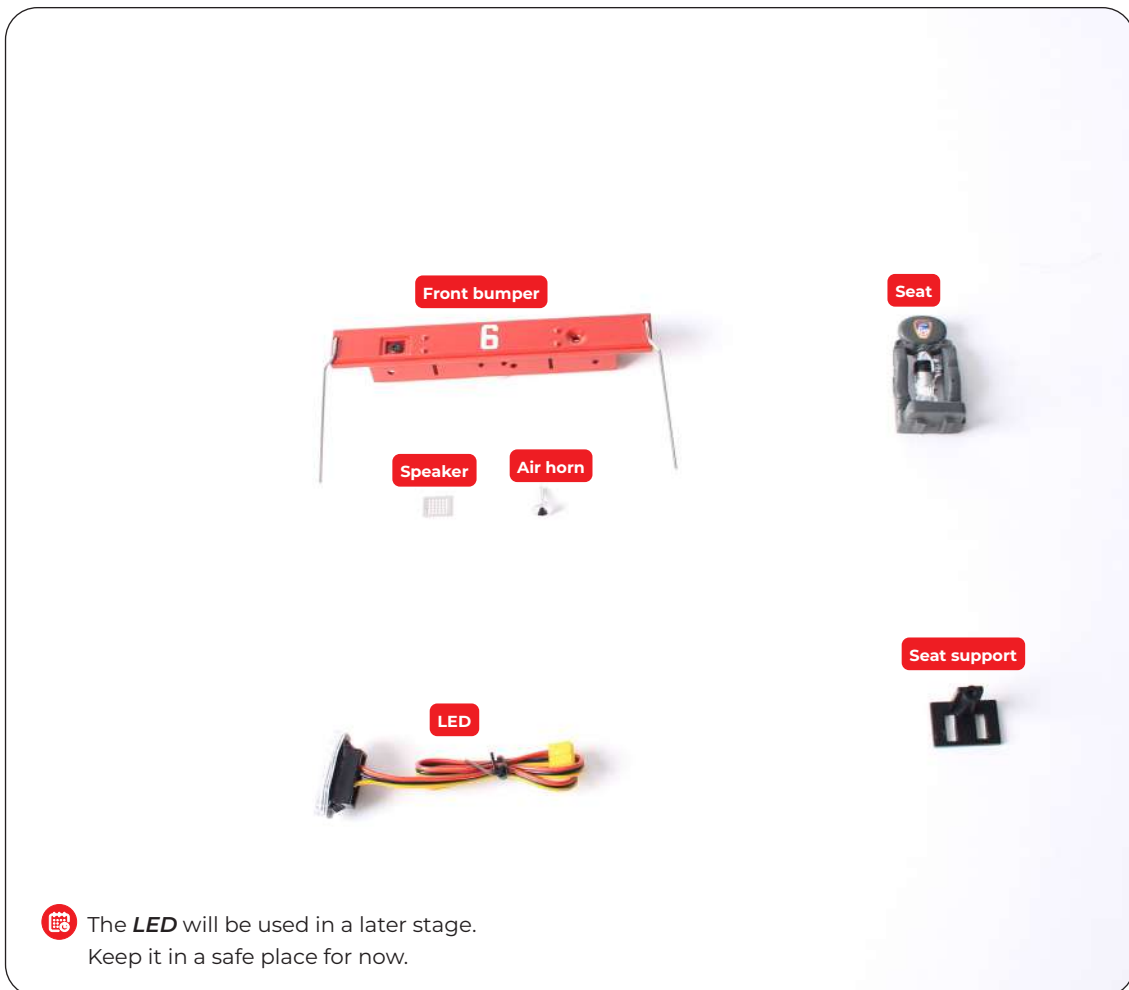

 The **LED** will be used in a later stage.  
Keep it in a safe place for now.

# Stage 04: Front Bumper, Air Horn, Speaker, & Seat

## STEP 1

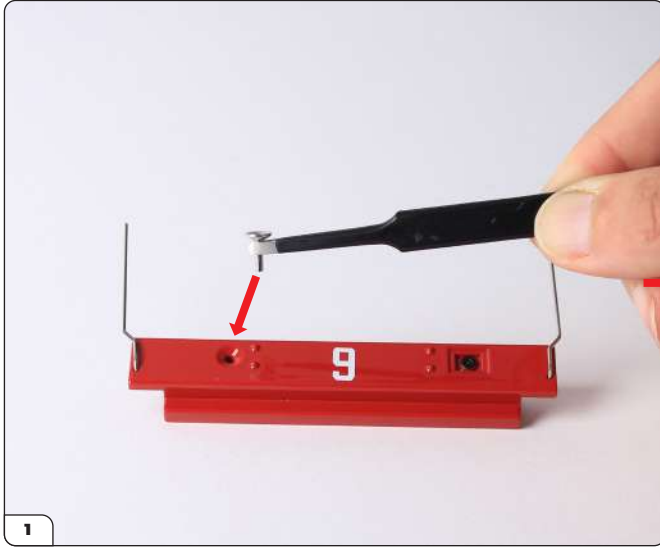

### FITTING THE AIR HORN

Push the air horn into the corresponding hole on the front bumper. Press firmly to fit.

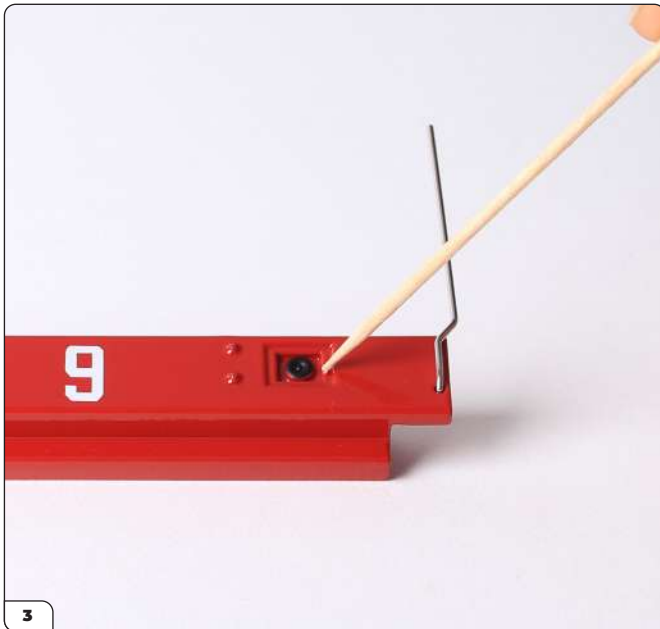

### FITTING THE SPEAKER

Apply a drop of superglue to the edges of the rectangular recess on the bumper.

Place the speaker over the recess and press until it adheres.

# Stage 04: Front Bumper, Air Horn, Speaker, & Seat

## STEP 2

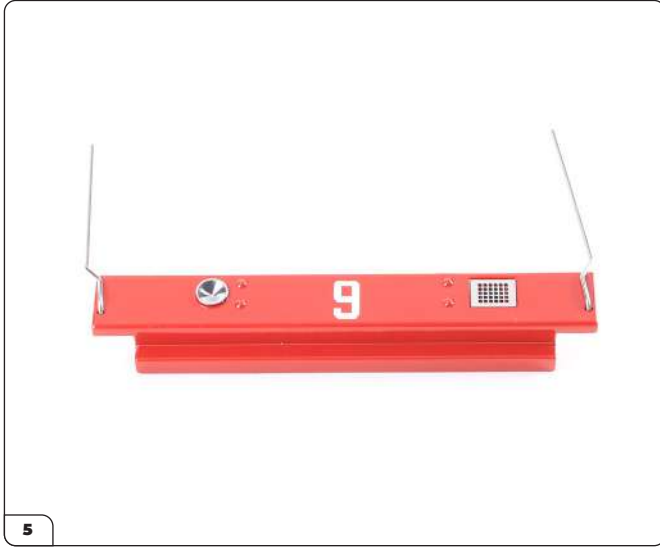

The air horn and speaker are now assembled on the bumper.



### ASSEMBLING THE SEAT

Apply a little superglue to the underside of the seat, avoiding the two rectangular tabs.



Take the seat support and align it with the seat as shown. Check you have the seat support in the correct orientation with the vertical post aligned with the back of the seat.



Firmly press the two parts together.

# Stage 04: Front Bumper, Air Horn, Speaker, & Seat

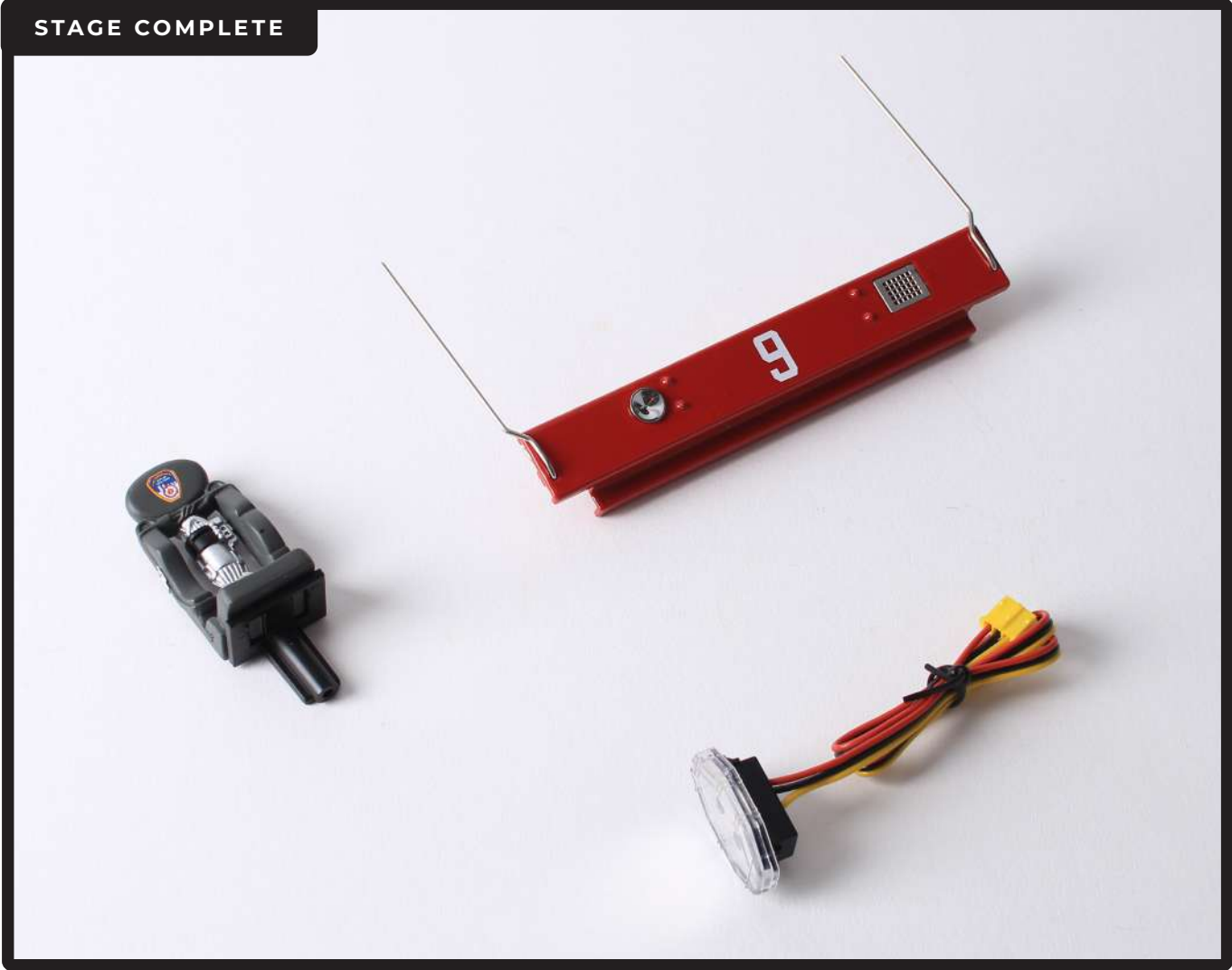

## Stage 05: Components for the Cab Roof

In this next stage you'll start to assemble the cab roof, adding a variety of components, including the left-hand side condenser and antenna.



### STAGE 05 PARTS LIST

Name
Condenser
Condenser grille frame
Condenser grille
Cab roof
Roof component c
Radio antenna
Roof component d
Antenna part a
Antenna part b

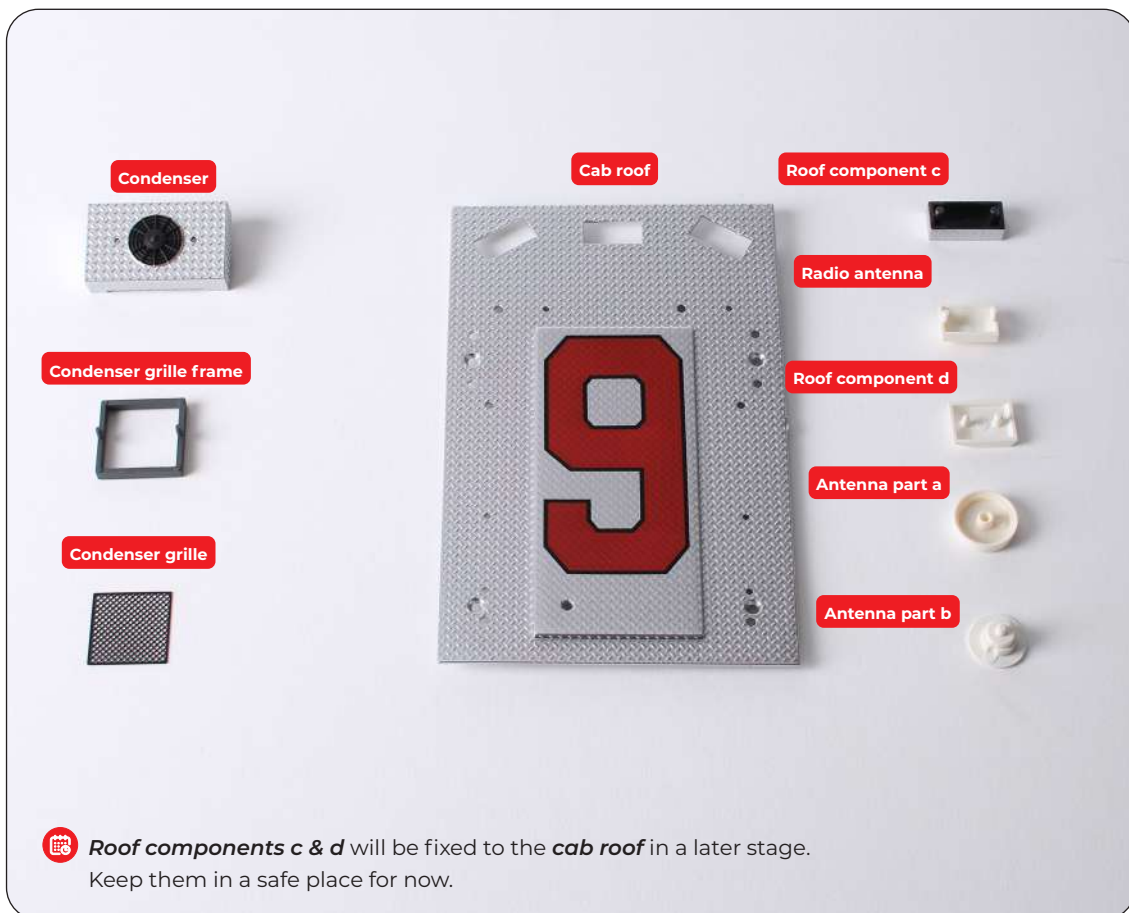

## Stage 05: Components for the Cab Roof

### STEP 1



#### ASSEMBLING THE ANTENNA

Take antenna part a and antenna part b, aligning them as shown before pushing firmly together.

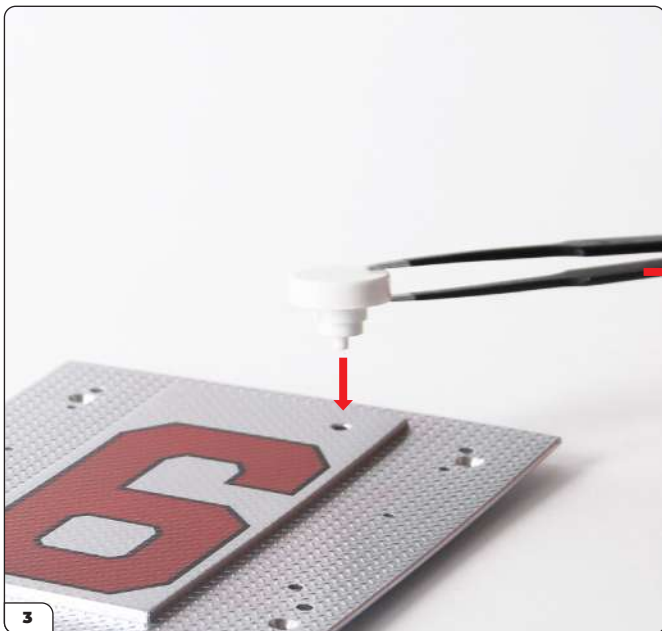

Align the assembled antenna with the hole in the cab roof as indicated and push firmly to fit.



# Stage 05: Components for the Cab Roof

## STEP 2

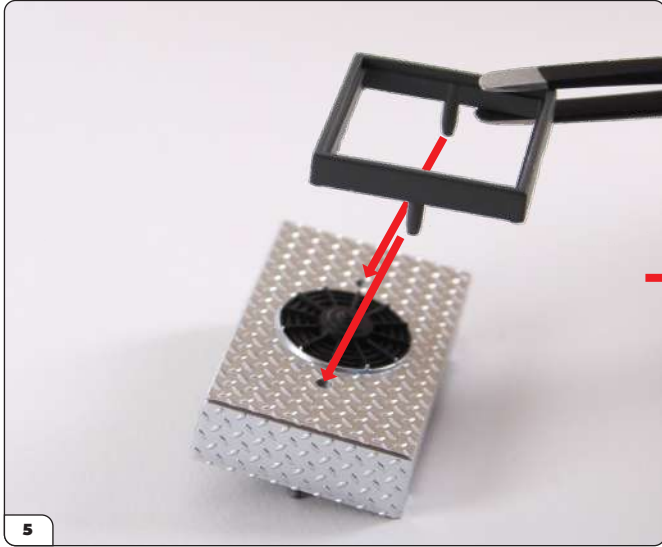

### ASSEMBLING THE CONDENSER

Take the condenser grille frame and align the two projecting pegs with the two corresponding holes on the condenser. Push the pegs firmly into the holes to fit.

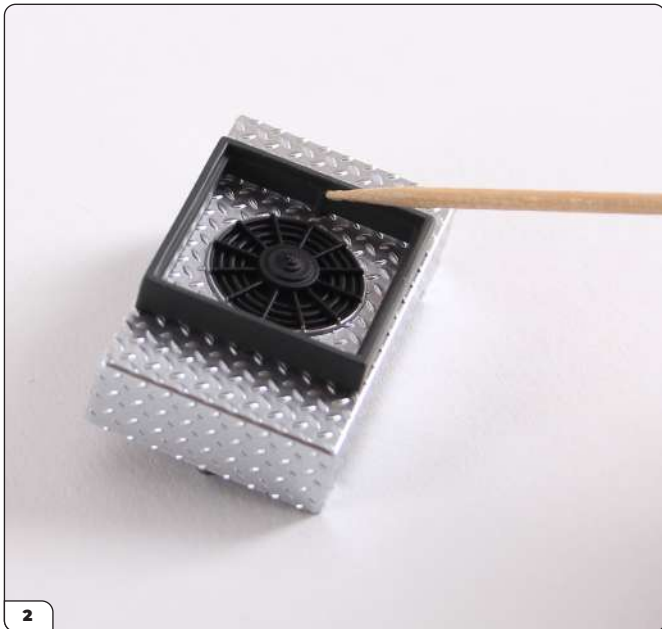

Apply a drop of superglue to the ledge around the condenser grille frame.

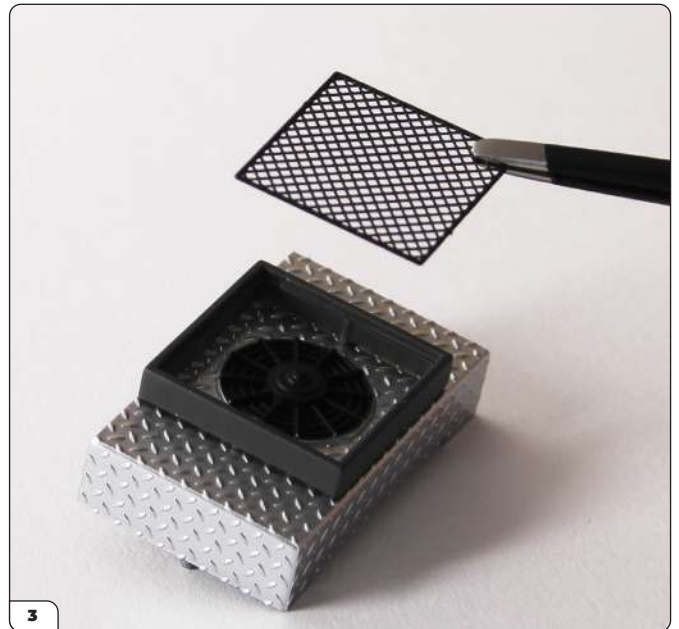

Carefully lay the condenser grille on the ledge.

## Stage 05: Components for the Cab Roof



The condenser grille has now been glued in place.

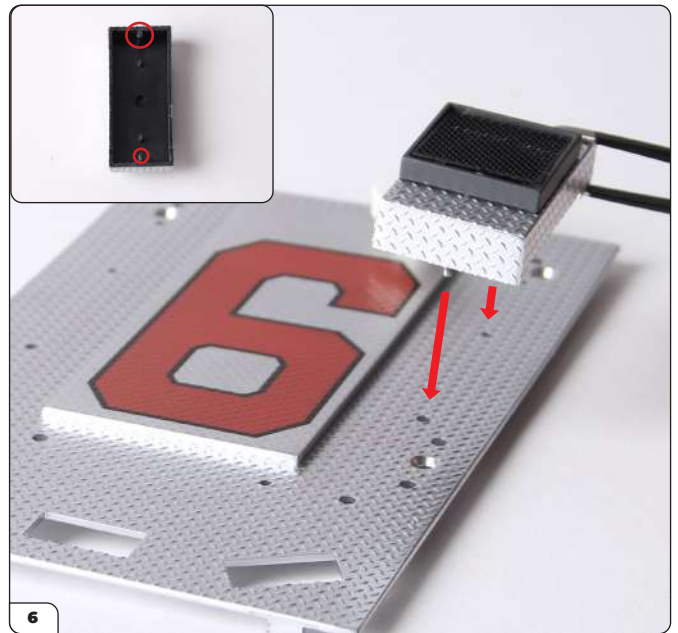

Push the two pegs on the underside of the condenser assembly into the corresponding holes in the cab roof. Note: the pegs and holes are different sizes to determine the correct fit.

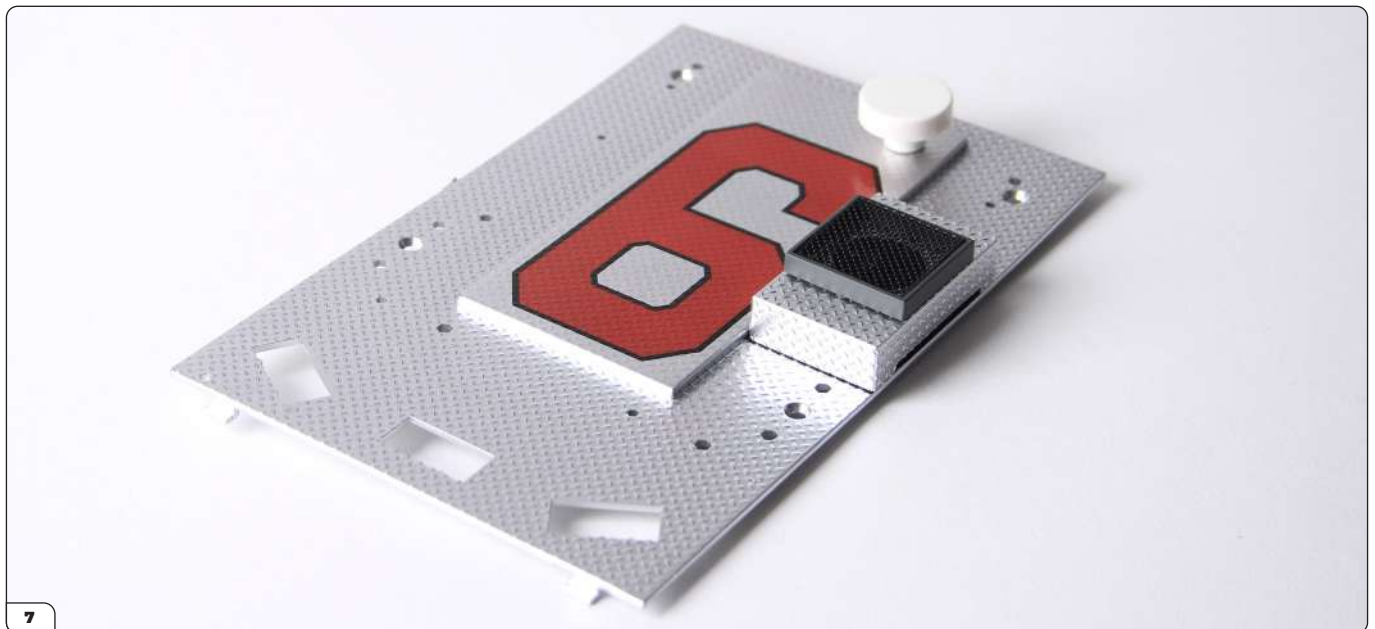

The left-hand condenser unit has now been fixed to the cab roof.

# Stage 05: Components for the Cab Roof

## STEP 3

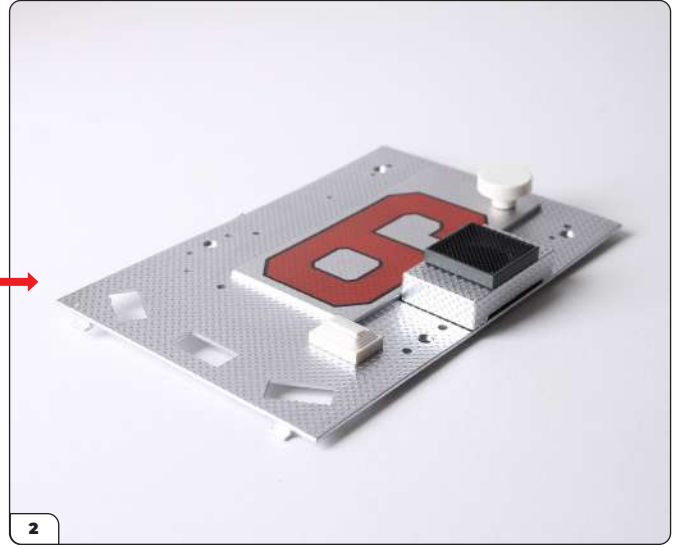
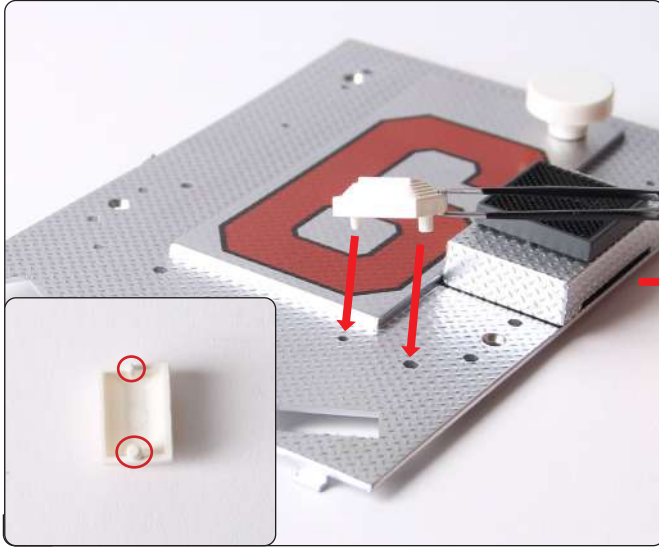

### FITTING THE RADIO ANTENNA

Take the left-hand radio antenna and note that the two pegs are different sizes. Determine the correct orientation by matching the pegs to the holes before pushing into place.

## STEP 4

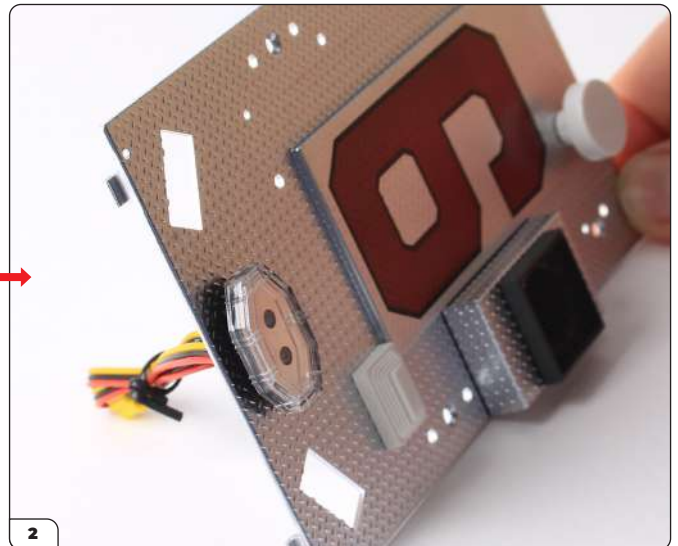
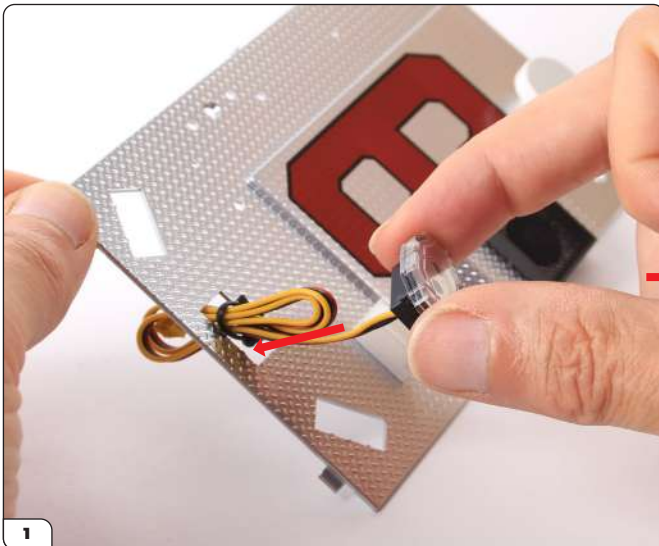



### INSTALLING THE LED

Install the LED from stage 04 by feeding the cable through the opening in the roof before pushing the mounting firmly into place.

## Stage 05: Components for the Cab Roof

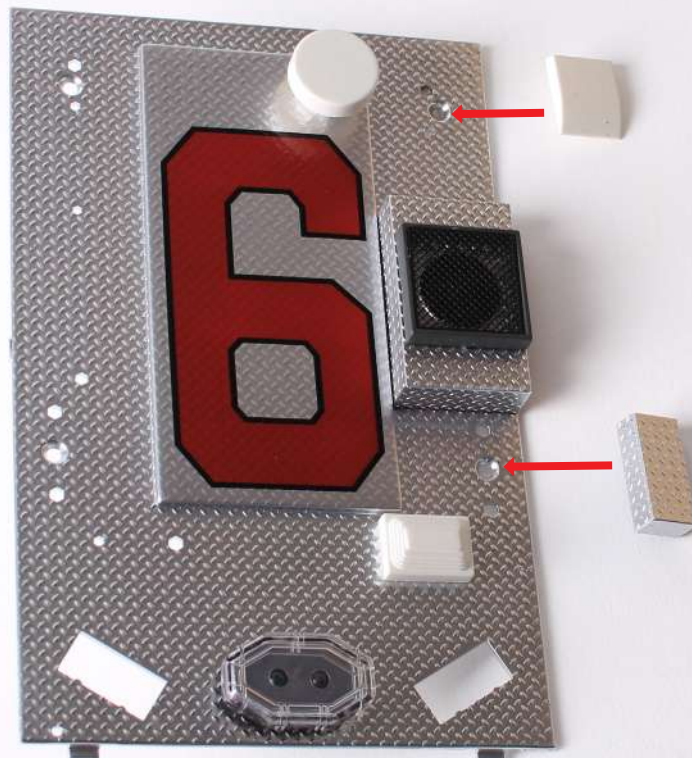
STAGE COMPLETE



 The **roof components c and d** will be fitted to the **cab roof** at a later stage. The arrows indicate where they will be fitted. For now, access is required to the screw holes that these parts will eventually cover.



## Stage 06: Assembling the Platform and Rear Axle

Next, you'll move on to the platform, assembling the four sides & adding some lights and handles. Then you will start to assemble the axle.

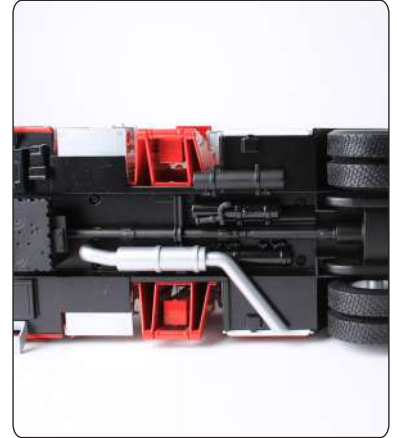

### STAGE 06 PARTS LIST

Name
Rear axle
Driveshaft
Platform right side
Platform back
Platform front light lenses
Platform left side
Platform front
Axle springs
Platform front lights
Rear platform light
Type A Screws x6
Type L Screws x2
Type C Screws x4
Platform handles x2



# Stage 06: Assembling the Platform and Rear Axle

## STEP 1

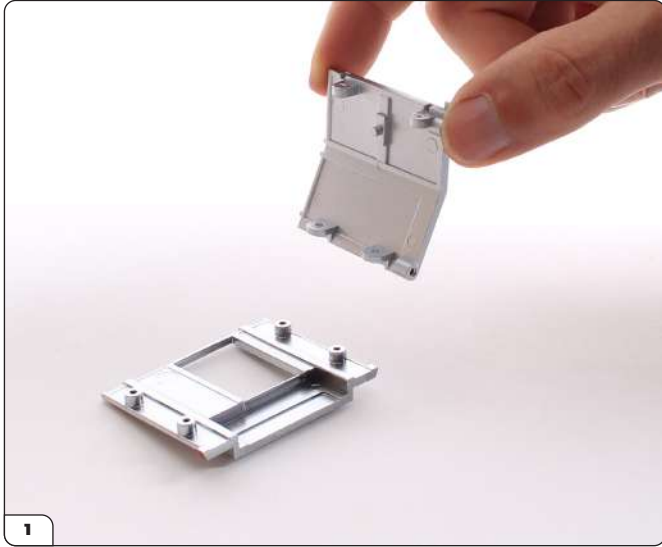

### ASSEMBLING THE PLATFORM

Take the platform front and platform right side. Fit the screw sockets on the platform right side over the corresponding sockets on the platform front.



Fix in place with 2 x TYPE A screws.



Take the platform left side and fit the screw sockets over the corresponding sockets on the platform front.

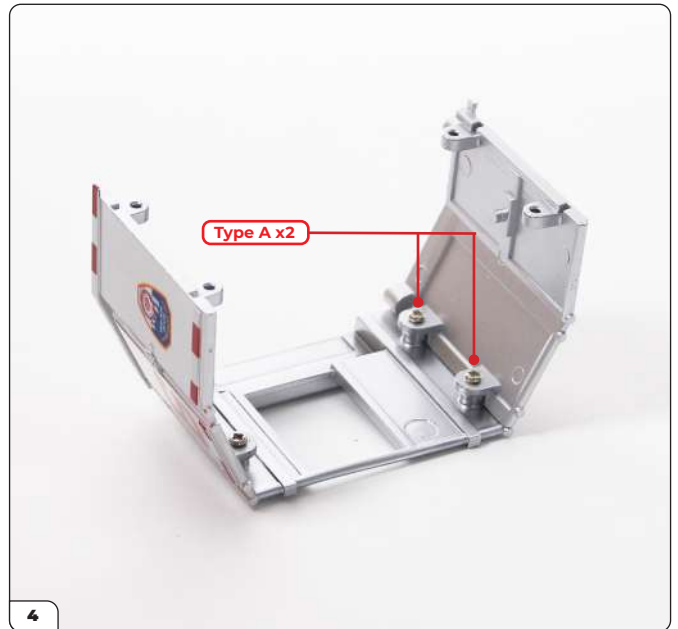

Fix in place with 2 x TYPE A screws.



## Stage 06: Assembling the Platform and Rear Axle



Take the platform back and fit the four screw holes over the four corresponding screw sockets on the platform sides.

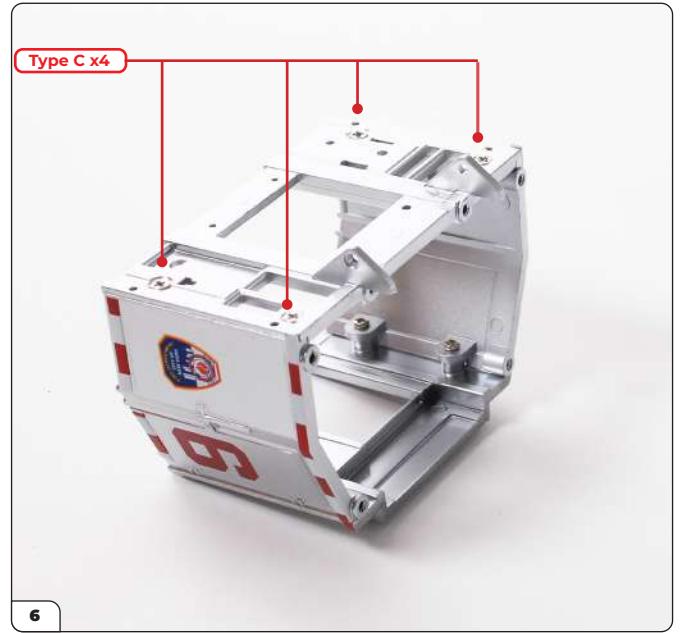

Fix in place with 4 x TYPE C screws.

### SEQUENCE

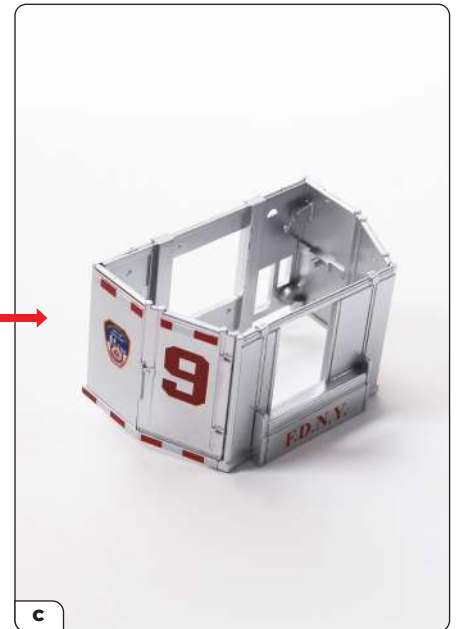
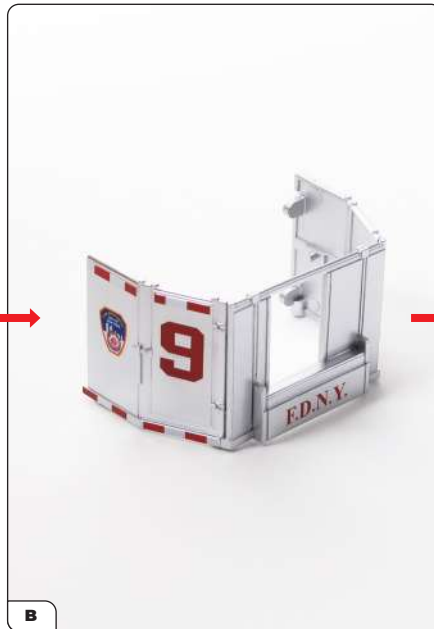

# Stage 06: Assembling the Platform and Rear Axle

## STEP 2



### ATTACHING THE SINGLE PLATFORM LIGHT

Test fit the single light by pushing the pin on the back into the corresponding D-shaped hole on the platform back. You may need to trim the flash to fit. Once you are happy with the fit, apply a tiny drop of superglue and push into place.

## STEP 3



### ATTACHING THE PLATFORM FRONT LIGHTS

Cut three lenses off the sprues and fit them into the corresponding mounts on the platform front lights. Apply a drop of PVA glue if necessary.

Three lenses have been fitted to the platform front lights.

## Stage 06: Assembling the Platform and Rear Axle

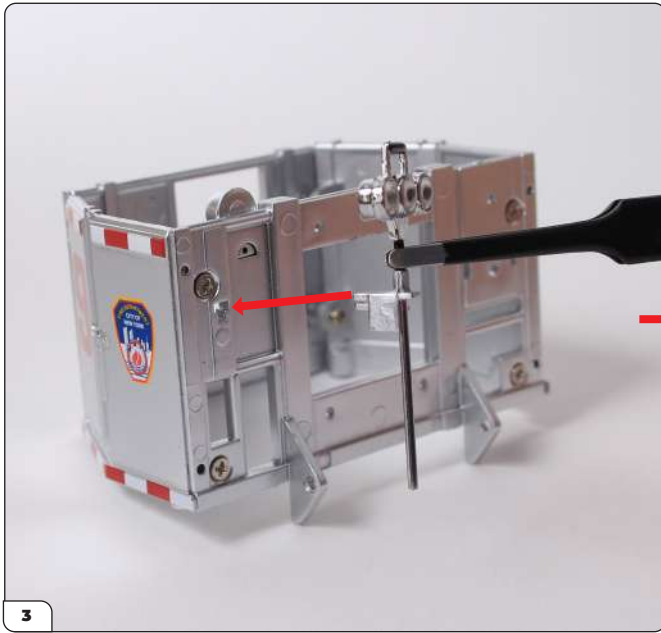

Identify the T-shaped fixing tab for the platform front lights and push it into the corresponding hole on the platform front. Apply a little superglue if necessary.

### STEP 4



### ATTACHING THE PLATFORM HANDLES

Take one of the platform handles and identify the two fixing points on the rear of the platform. Apply a little superglue to the two pins on the handle, then push into place.

## Stage 06: Assembling the Platform and Rear Axle

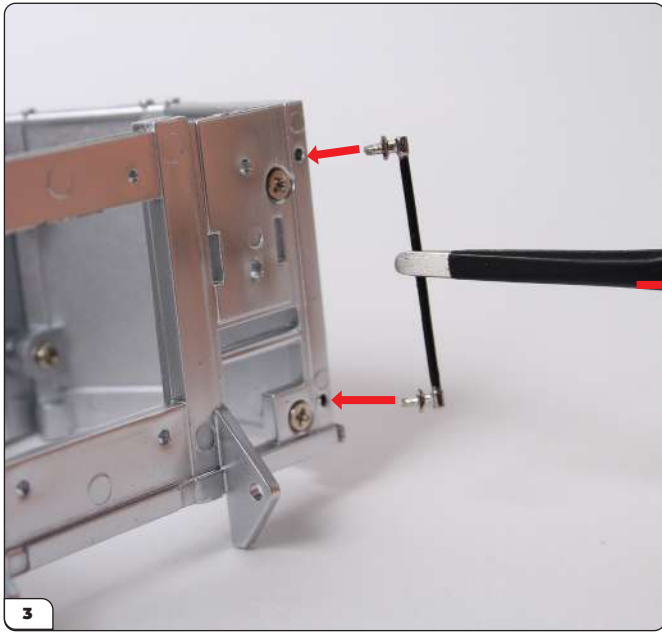

Fix the second platform handle to the opposite side on the rear of the platform in the same way.

### STEP 5



#### ASSEMBLING THE AXLE, DRIVESHAFT AND WHEEL

Take the driveshaft and identify the end with a screw hole. Align with the corresponding screw hole on the axle. Note: the post on the driveshaft should point upwards (see the Stage Complete photo on page 38).

Fix in place with a TYPE A screw.

## Stage 06: Assembling the Platform and Rear Axle



Take the wheel from stage 01 and push it onto the rear right axle post as shown. Check you have placed it in the correct orientation.



Fix in place with a TYPE L screw.



Take the hubcap from stage 01 and push it over the screw fixed in picture 4.



The wheel has now been fixed to the axle.



## Stage 06: Assembling the Platform and Rear Axle



Place the four axle springs on the axle posts as shown, or keep them in a safe place until you start the next stage.





# Stage 07: Left-Hand Side Storage Compartment

In stage 7, you'll assemble one of the fire truck storage compartments, used to house vital rescue equipment.



## STAGE 07 PARTS LIST

Name
Left-hand door front
Left-hand door back
Compartment inner
Shelf top
Right-hand door front
Right-hand door back
Magnet
Shelf bottom



# Stage 07: Left-Hand Side Storage Compartment

## STEP 1

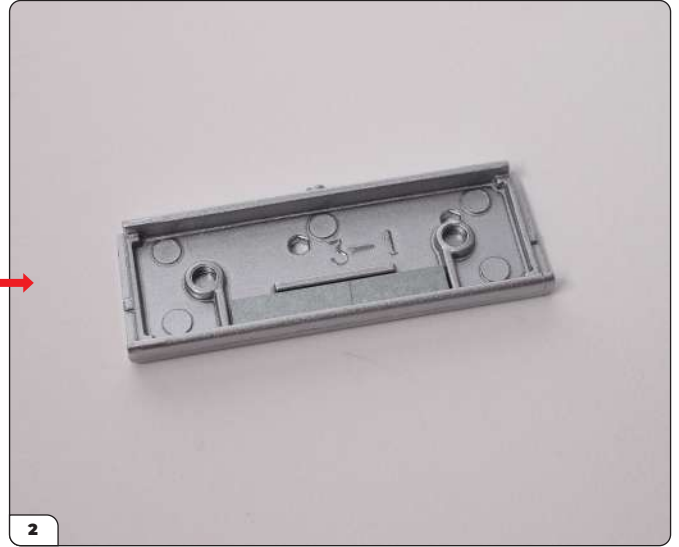
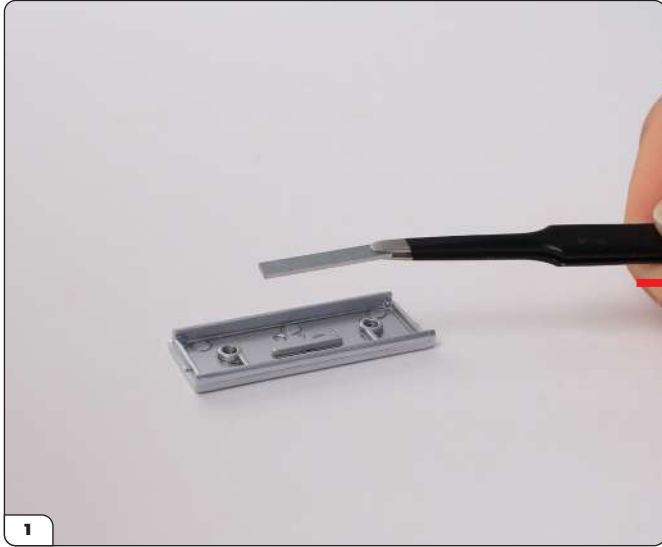

### ASSEMBLING THE SHELF

Take the shelf bottom and position the magnet between the two tabs as shown in picture 2.

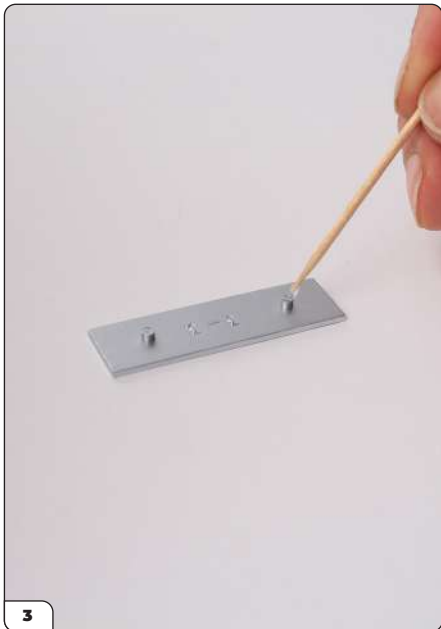

Test fit the shelf top to the shelf bottom and check you have the correct orientation, with the two holes as shown in picture 5. Once you're happy, apply a drop of glue to the two pins on the shelf top.

Align the pins with the corresponding holes in the shelf bottom.

Push the parts together until the glue adheres.

# Stage 07: Left-Hand Side Storage Compartment

## STEP 2

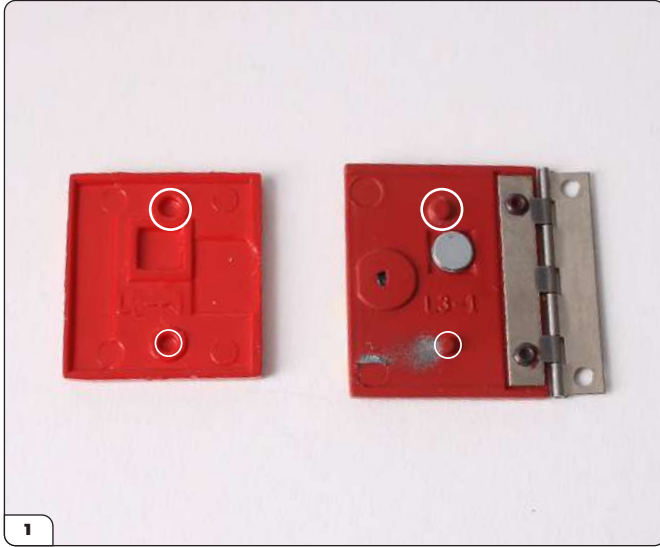

### ASSEMBLING THE LEFT-HAND DOOR

Take the left-hand door front and left-hand door back. Test fit the parts, noting that the peg and hole fixings are different sizes to ensure the correct fit. Note that both the door front and back are engraved with L3-1 for easy identification.

Apply a little glue to the two peg holes on the door back.

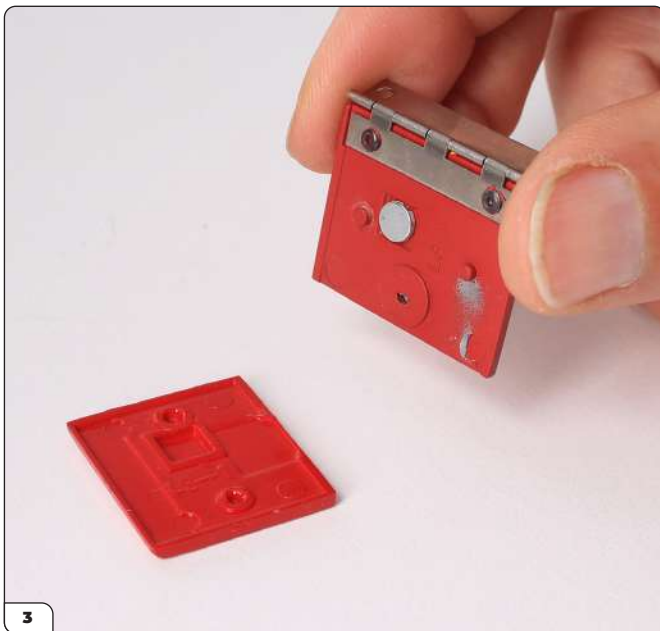

Fix the door back and door front together.



This shows the doors correctly assembled from the front and back views.

# Stage 07: Left-Hand Side Storage Compartment

## STEP 3

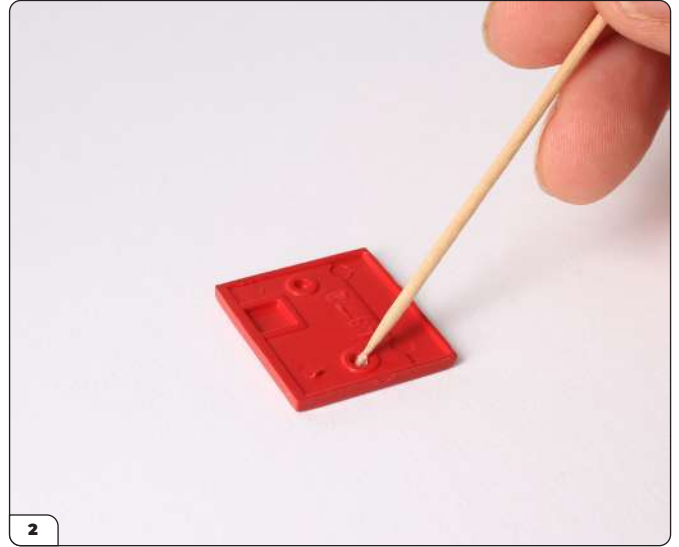

### ASSEMBLING THE RIGHT-HAND DOOR

Take the right-hand door front and right-hand door back. Test fit the parts, noting that the peg and hole fixings are different sizes to ensure the correct fit. Note that both the door front and back are engraved with L3-2 for easy identification.

Apply a little glue to the two peg holes on the door back.

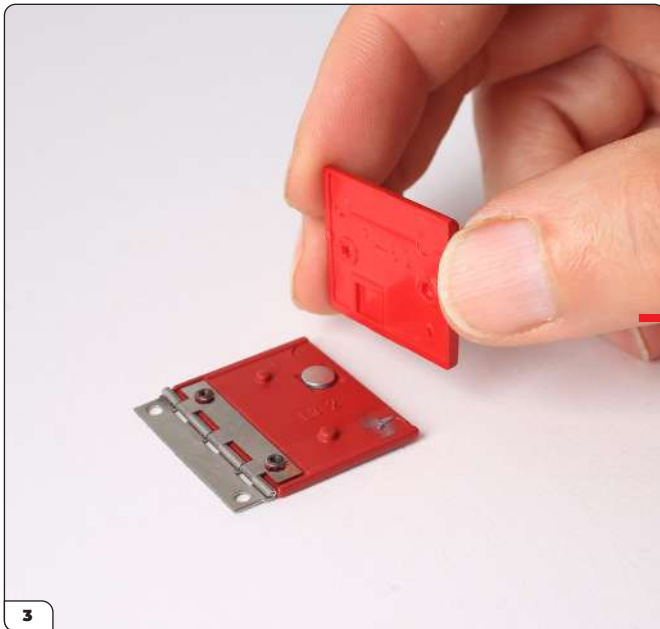

Fix the door back and door front together.

# Stage 07: Left-Hand Side Storage Compartment

## STEP 4

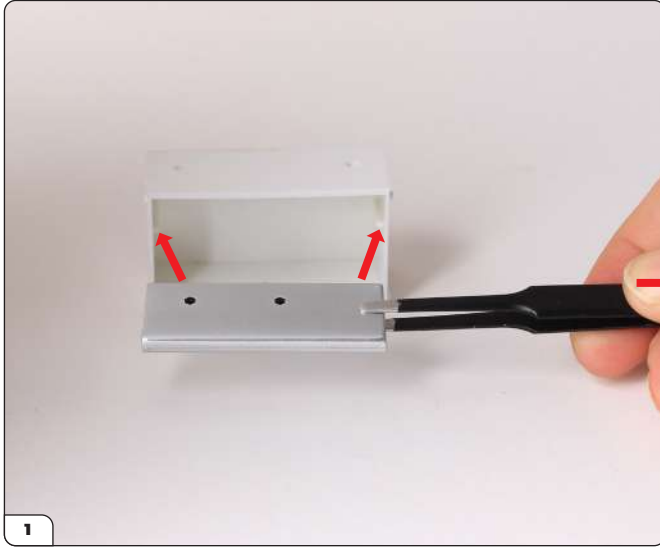

### FIXING THE SHELF AND DOORS TO THE STORAGE COMPARTMENT INNER

Take the compartment inner and shelf. Ensure that the holes on the shelf are facing upwards before installing it onto the brackets on each side of the compartment inner. Do not glue as the shelf will slide in and out to store equipment at a later stage.

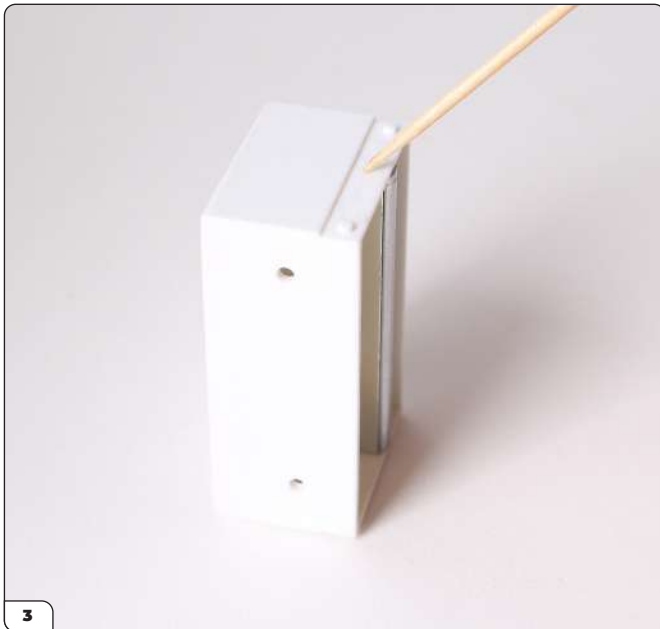

Apply a drop of glue to the recess on the left-hand side of the compartment inner.

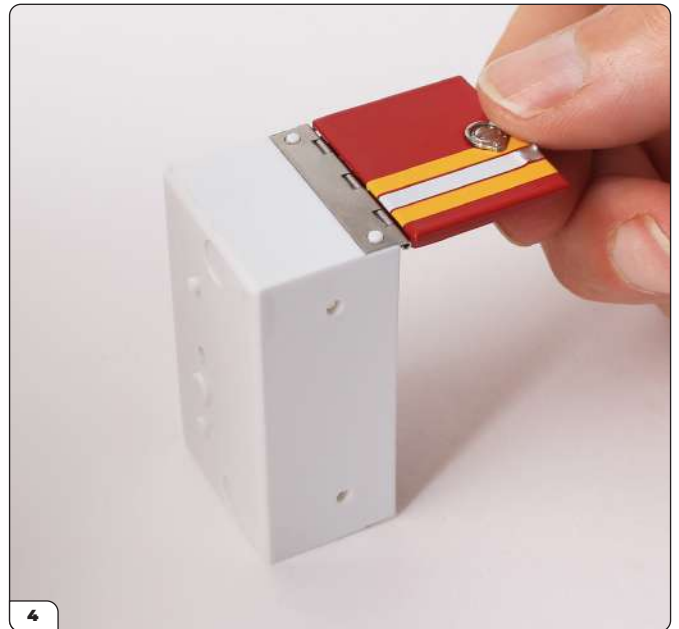

Align the peg holes with the pegs and fix the left-hand door in place.



## Stage 07: Left-Hand Side Storage Compartment

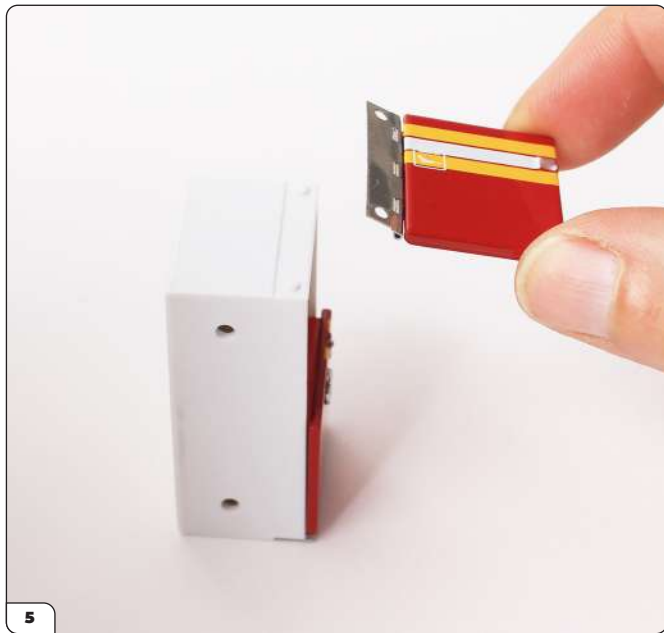

Apply a little more glue to the recess on the right hand side of the compartment inner.

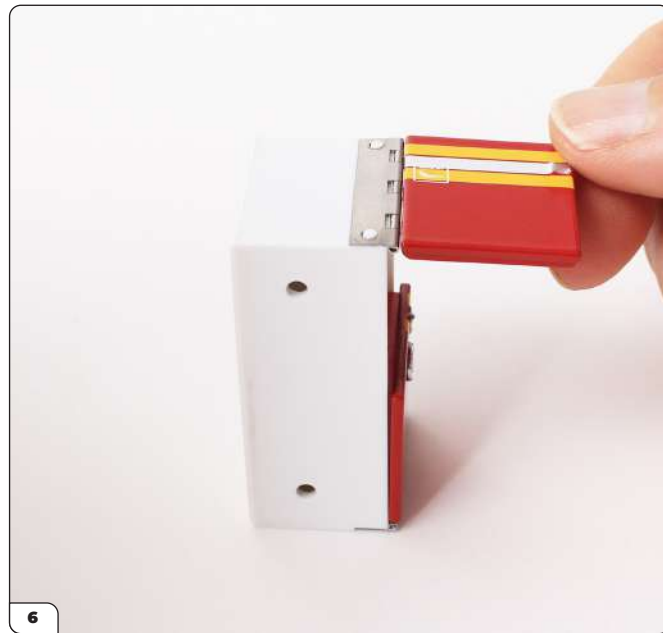

Press firmly to fix the right-hand door in place.



Both doors have been fixed to the storage compartment.



## Stage 08: Handy Screw Identifier

Please keep any unused screws supplied throughout your build. This handy screw reference will help you determine which screws to use as you progress with your model.

### STAGE 08 PARTS LIST

