



Pack 07

BUILD INSTRUCTIONS

**STAGE 50: CONNECTING THE POWER SWITCH,
SPEAKER AND BATTERY CABLES**

**STAGE 55: APPLYING CARPET TO
THE REAR LEFT SIDE PANEL**

STAGE 51: CONNECTING THE FIRST LED CABLES

**STAGE 56: APPLYING CARPET TO
THE REAR RIGHT SIDE PANEL**

**STAGE 52: CONNECTING THE SECOND
LED CABLES**

**STAGE 57: FITTING THE REAR PANEL
AND CROSS MEMBER**

**STAGE 53: BUILDING THE REMOTE CONTROL
AND TESTING THE ELECTRONICS**

STAGE 58: FITTING THE LEFT SIDE PANEL

**STAGE 54: APPLYING CARPET TO THE
INTERIOR FLOOR**

STAGE 59: FITTING THE RIGHT SIDE PANEL

General Motors Trademarks used under license by Premium & Collectibles Trading Co. Ltd on behalf of Agora Models.

**AGORA
MODELS®**

Advice from the experts

Spare screws are included with each part. Occasionally, you may be instructed to keep spare or unused screws for a later stage. Keep these spares in a safe place and label them correctly.

Please make sure you don't mix up the screws. They look quite similar, but the threads do vary slightly. Using the wrong screws may damage the parts.

When securing parts together using multiple screws, fit each screw loosely to ensure all the parts are correctly aligned before gently tightening them firmly, but not overtight, in the order in which you placed them.

The screwdriver can be magnetized by stroking it with a magnet (fridge magnet, etc.) enabling it to hold the screws and make assembly easier.

If a screw is tight going into a metal part, do not force it as you may shear the head off. Remove it and put a tiny smear of Vaseline, soap or light oil on the thread. That will lubricate it and make it easier to drive home.

During the course of this build, you will receive many pieces that you will assemble immediately – following the instructions in the corresponding stage – and other pieces that you should store safely to one side, for use in future assembly stages.

Left and Right! When building your Corvette, the left- or right-hand side refers to that side as if you are sitting in the car.



WARNING: Some parts are assembled using magnets. These magnets can cause serious injury if they are swallowed. Keep away from children. If you suspect a magnet has been swallowed, seek medical help straight away.

Stage 50: Connecting the Power Switch, Speaker and Battery Cables

In this stage you'll install the circuit board that controls the model's electronics, then connect the power switch, speaker and battery cables.



STAGE 50 PARTS LIST

Name
Circuit board
Power switch
Engine mount plug x2
Power switch extension cable
EP screws x5
LP screws x3

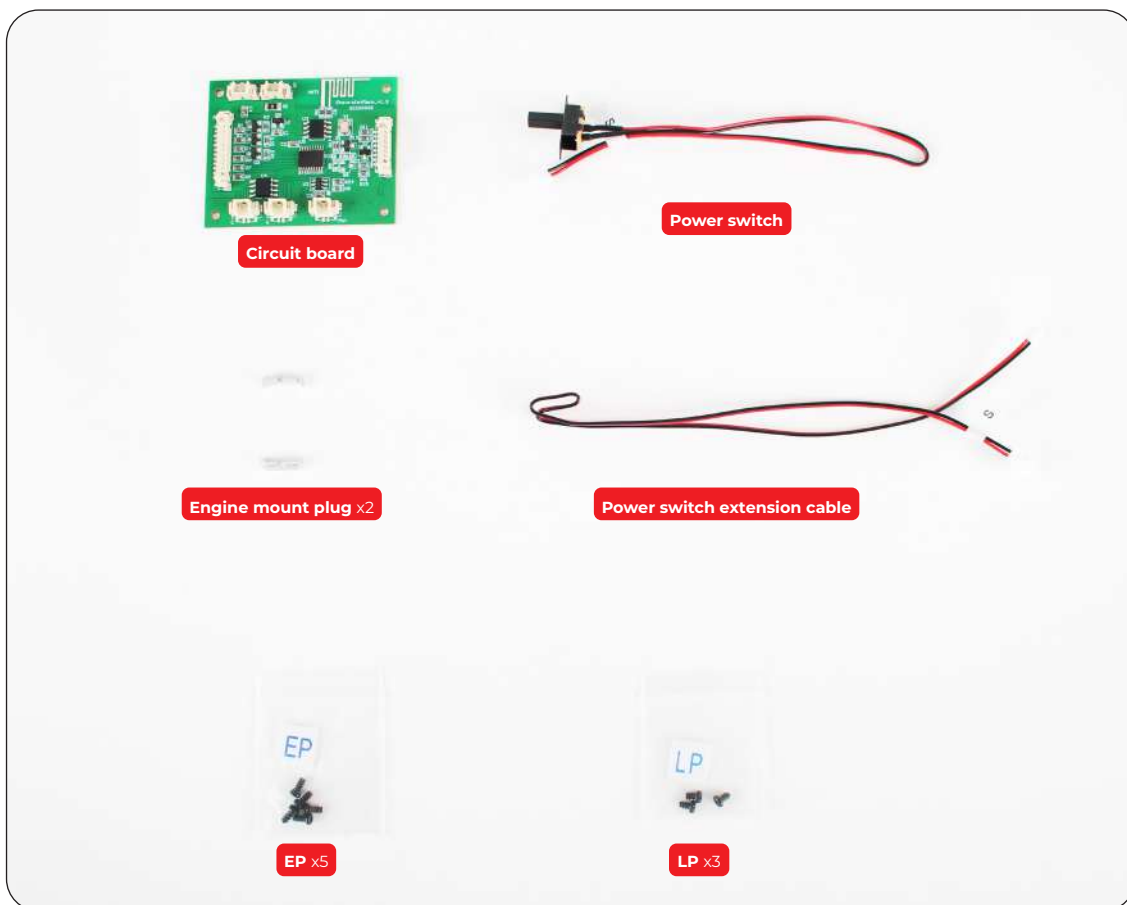

Stage 50: Connecting the Power Switch, Speaker and Battery Cables

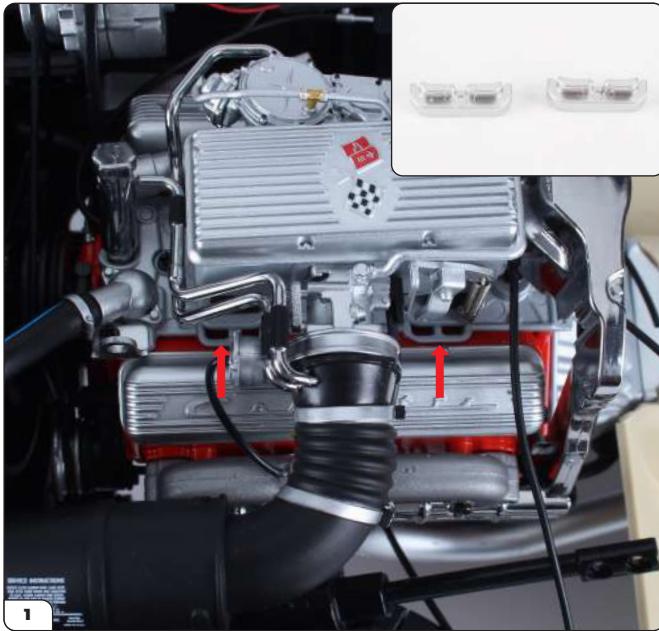

On the main assembly, find the two spaces for fitting the engine mount plugs (inset). The plugs are identical and can be used interchangeably.



Using tweezers, fit one of the plugs into the space as shown. To avoid scratches, you can cover the tweezers with masking tape (inset).

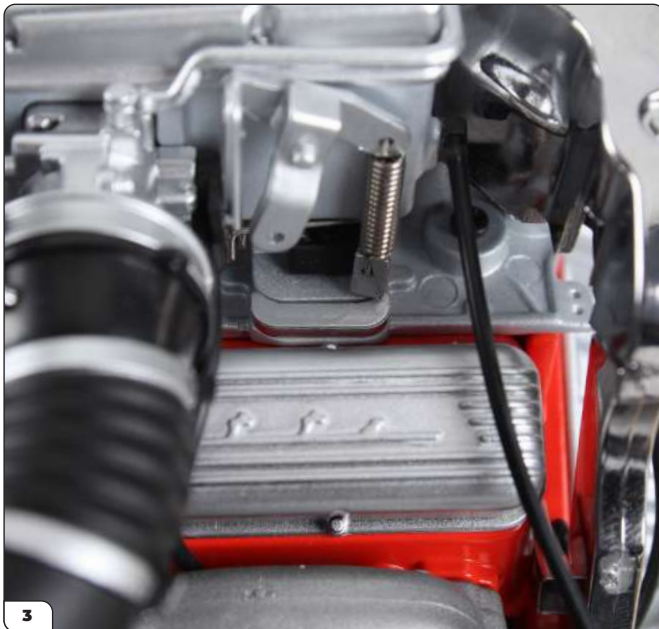

Press the plug in place.



Fit the remaining plug in place in the same way.

Stage 50: Connecting the Power Switch, Speaker and Battery Cables

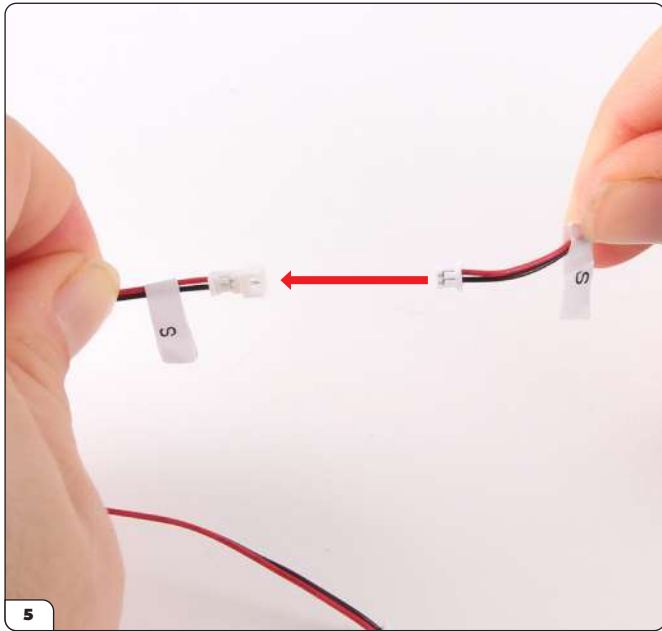

Connect the power switch and the extension cable (both labelled 'S') together as shown.

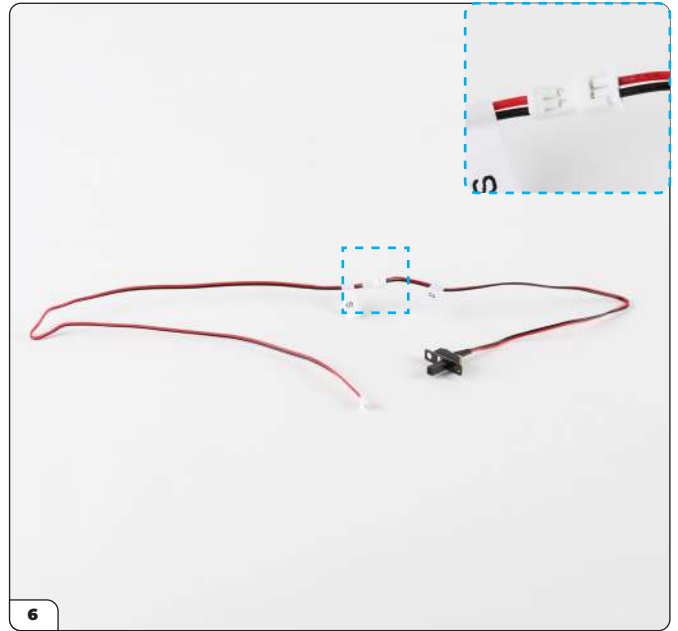

Before fitting the circuit board, ensure the black and red wires are moved away from the battery compartment as shown.

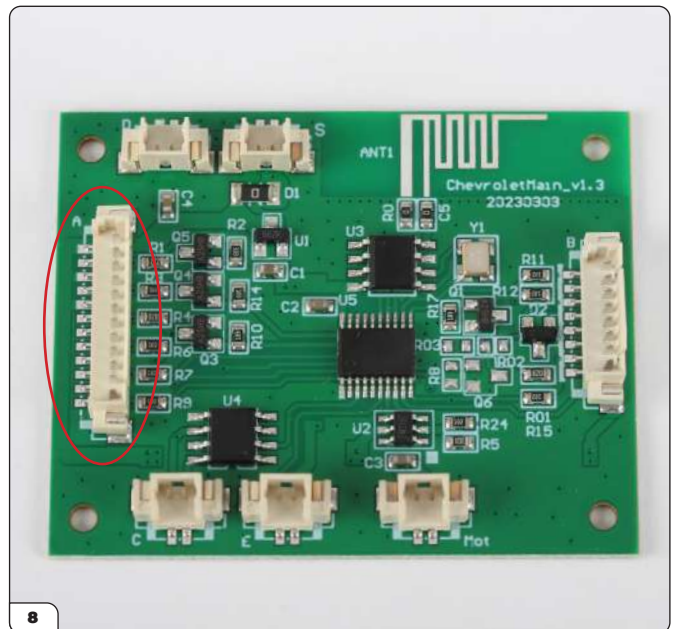

Take the circuit board – each socket is marked with the corresponding cable letter. Note the 'A' socket (circled).

Stage 50: Connecting the Power Switch, Speaker and Battery Cables

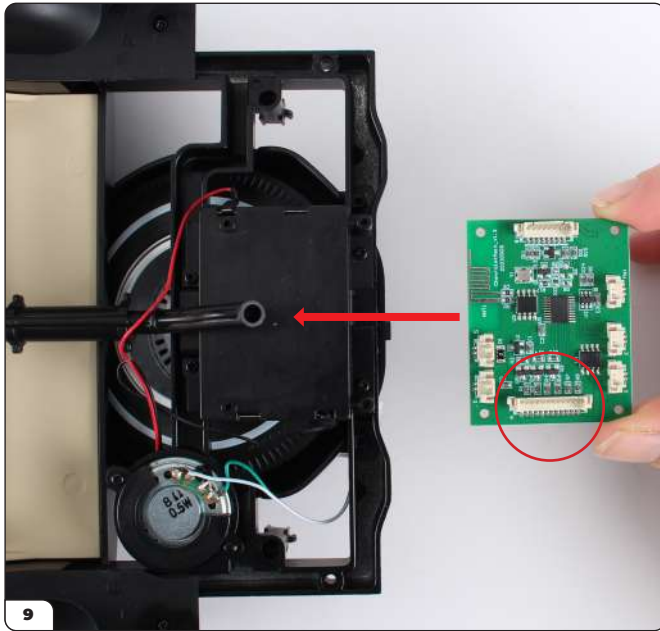

Align the circuit board with the battery compartment. The 'A' socket should be on the left side of the car (circled).

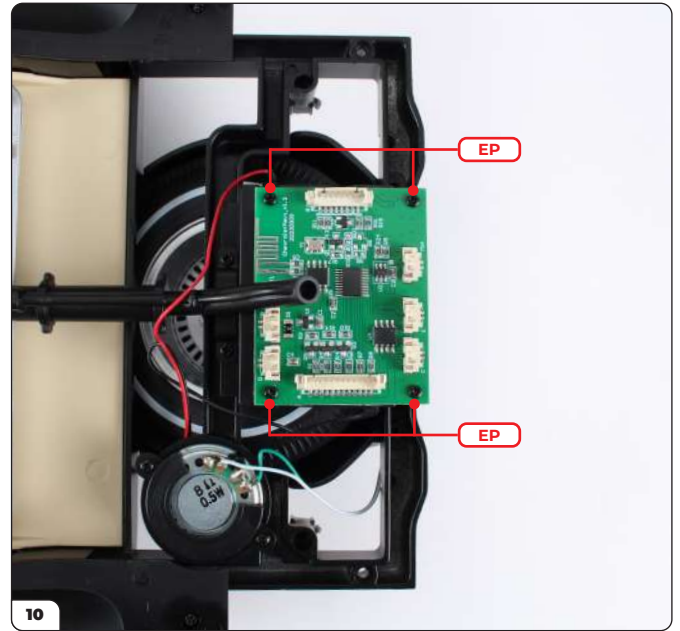

Secure in place using 4x EP screws.

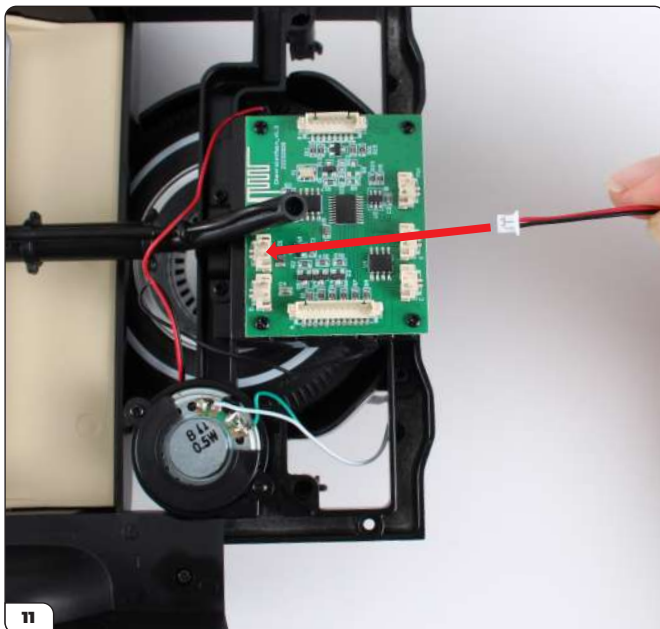

Plug the power switch extension cable into the 'S' socket.

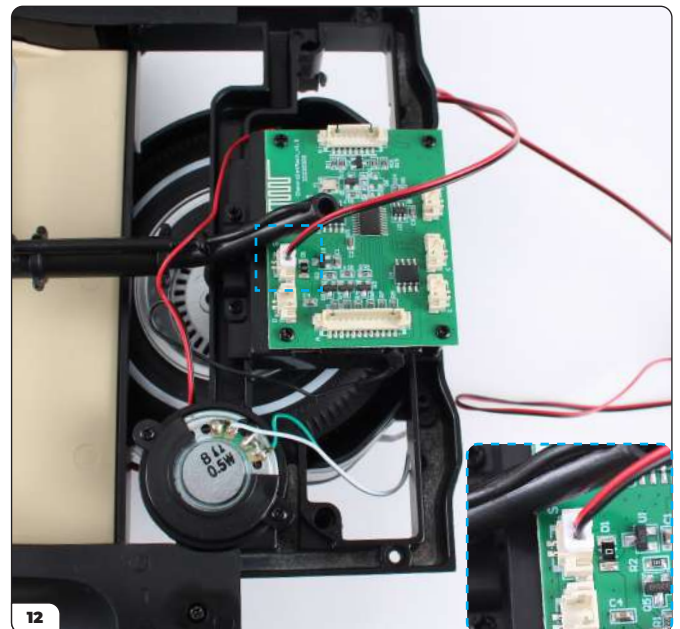

Stage 50: Connecting the Power Switch, Speaker and Battery Cables

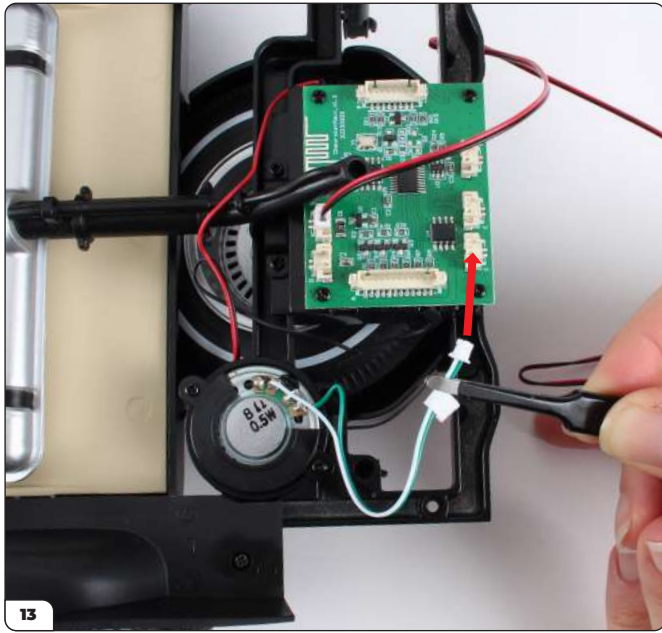

Plug the white and green speaker cable into the 'C' socket.

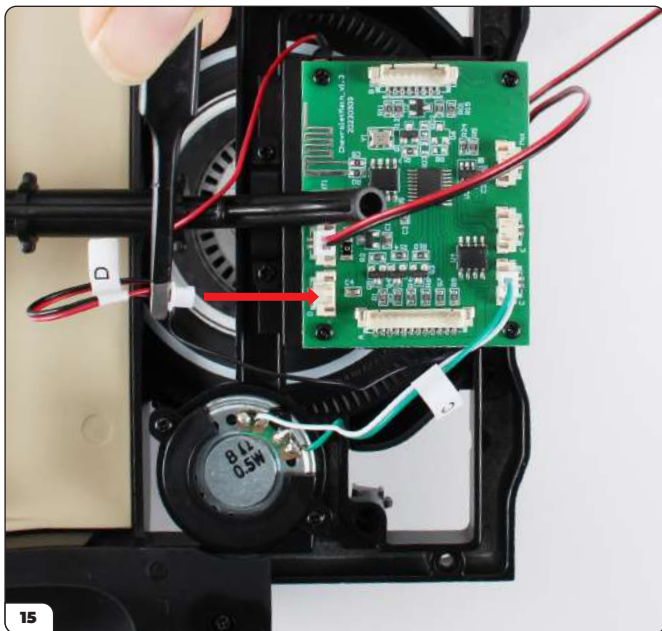
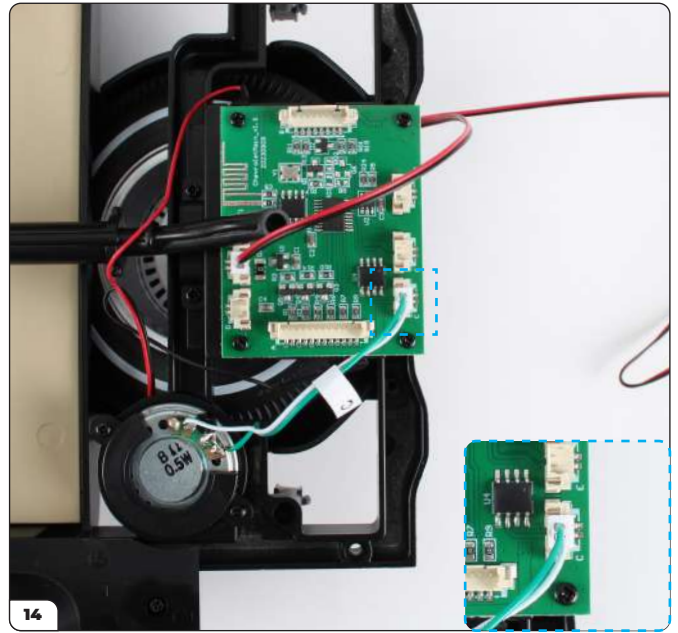

Plug the black and red battery cable into the 'D' socket.

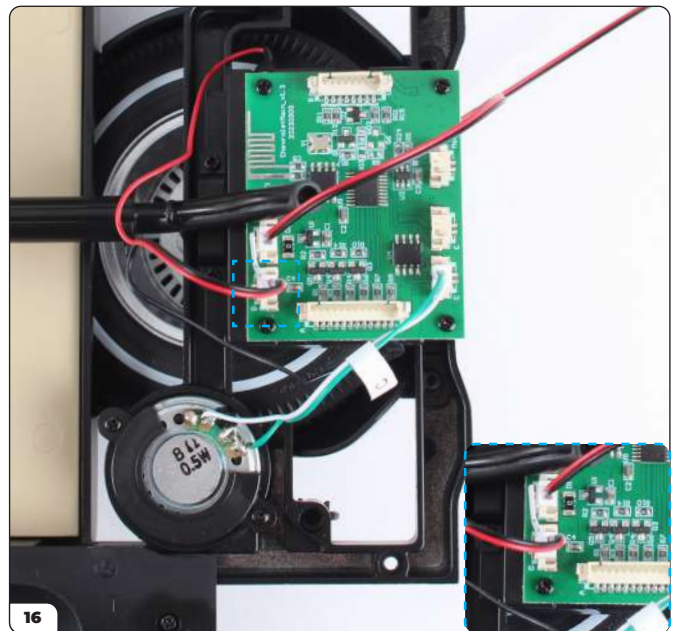

Stage 50: Connecting the Power Switch, Speaker and Battery Cables

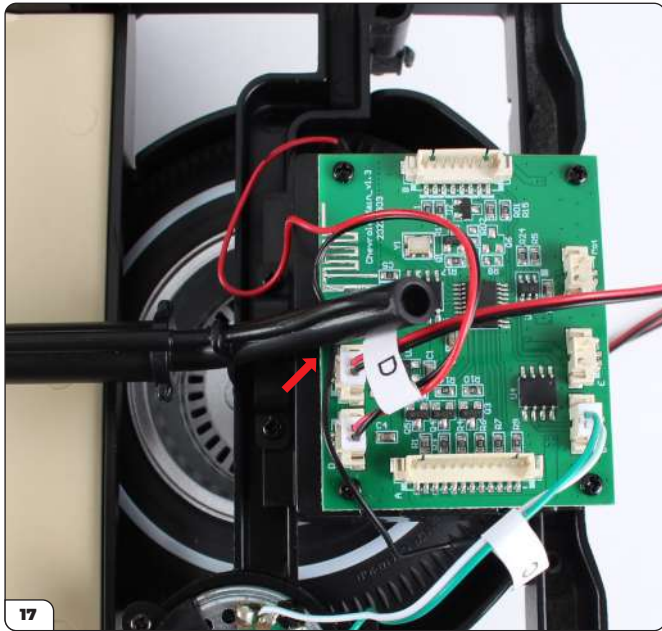

Tuck the 'D' cable underneath the fuel hose as shown.

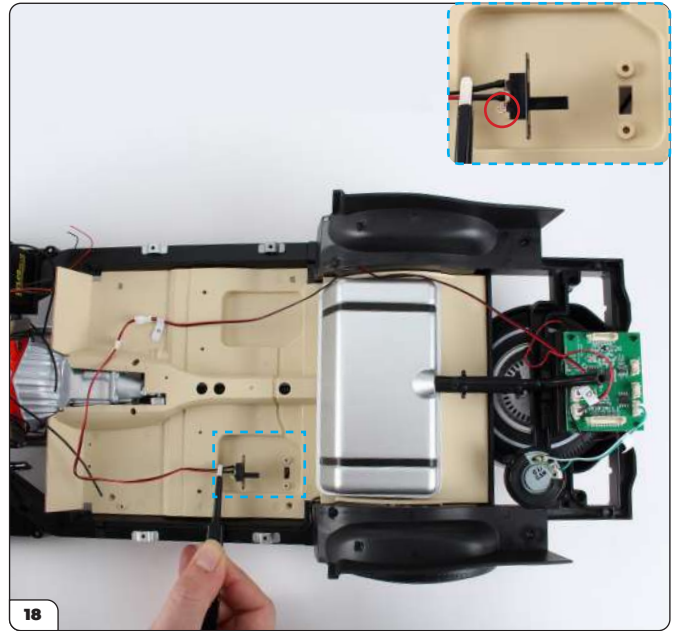

Route the power switch cable around the fuel tank then align the switch with the opening in the cockpit floor as shown. Ensure the switch is aligned in the correct orientation (inset).

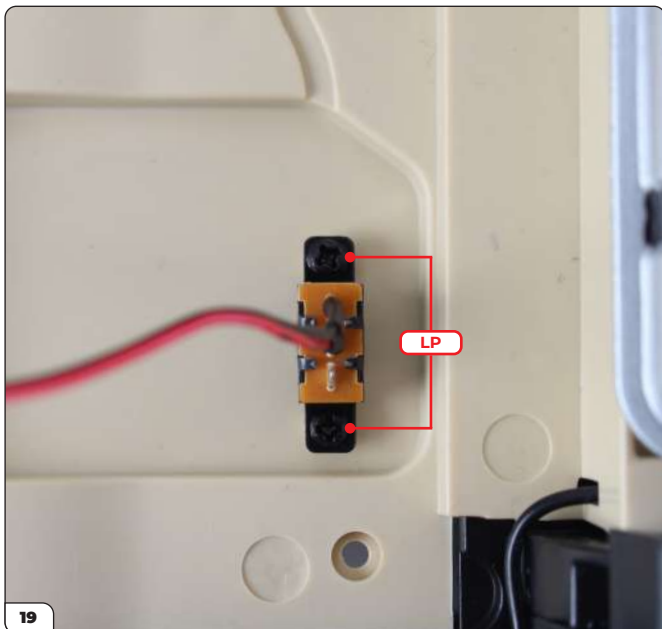

Fit the switch then secure using 2x LP screws.

Stage 50: Connecting the Power Switch, Speaker and Battery Cables

STAGE COMPLETE

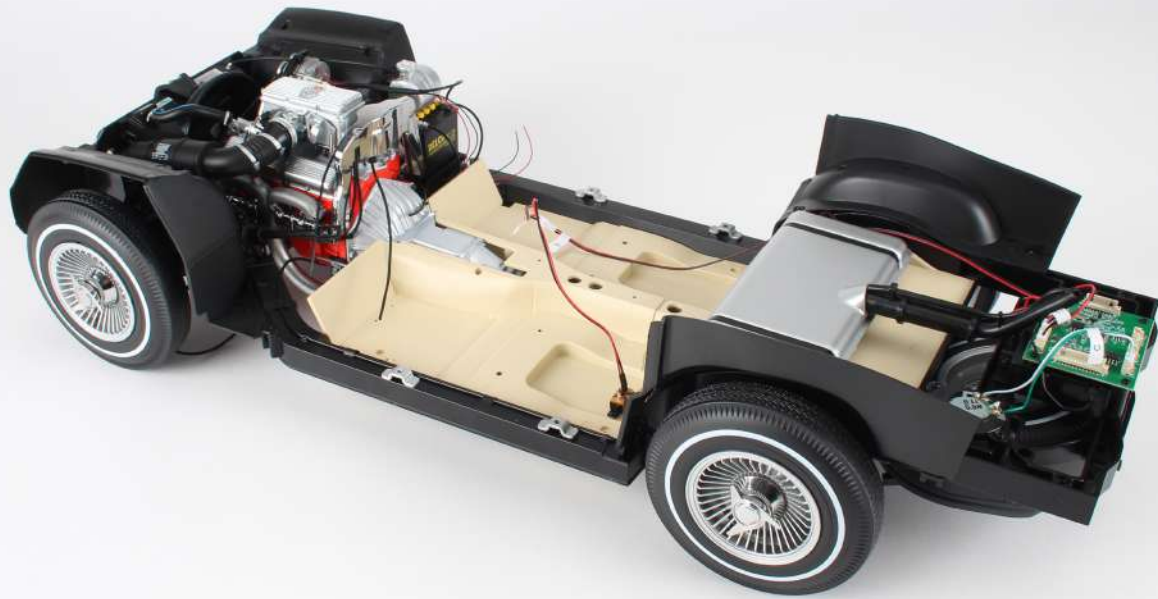

Stage 51: Connecting the First LED Cables

After connecting the first LED cables together you'll plug them into the circuit board.



STAGE 51 PARTS LIST

Name	Name
Splitter 'A1-A6'	Extension cable 'A3'
Extension cable 'A1'	LED cable 'A4'
LED cable 'A1' (long)	Extension cable 'A4'
LED cable 'A1' (short)	LED cable 'A5'
Extension cable 'A2'	Extension cable 'A5'
LED cable 'A2' (long)	LED cable 'A6'
LED cable 'A2' (short)	Extension cable 'A6'
LED cable 'A3'	

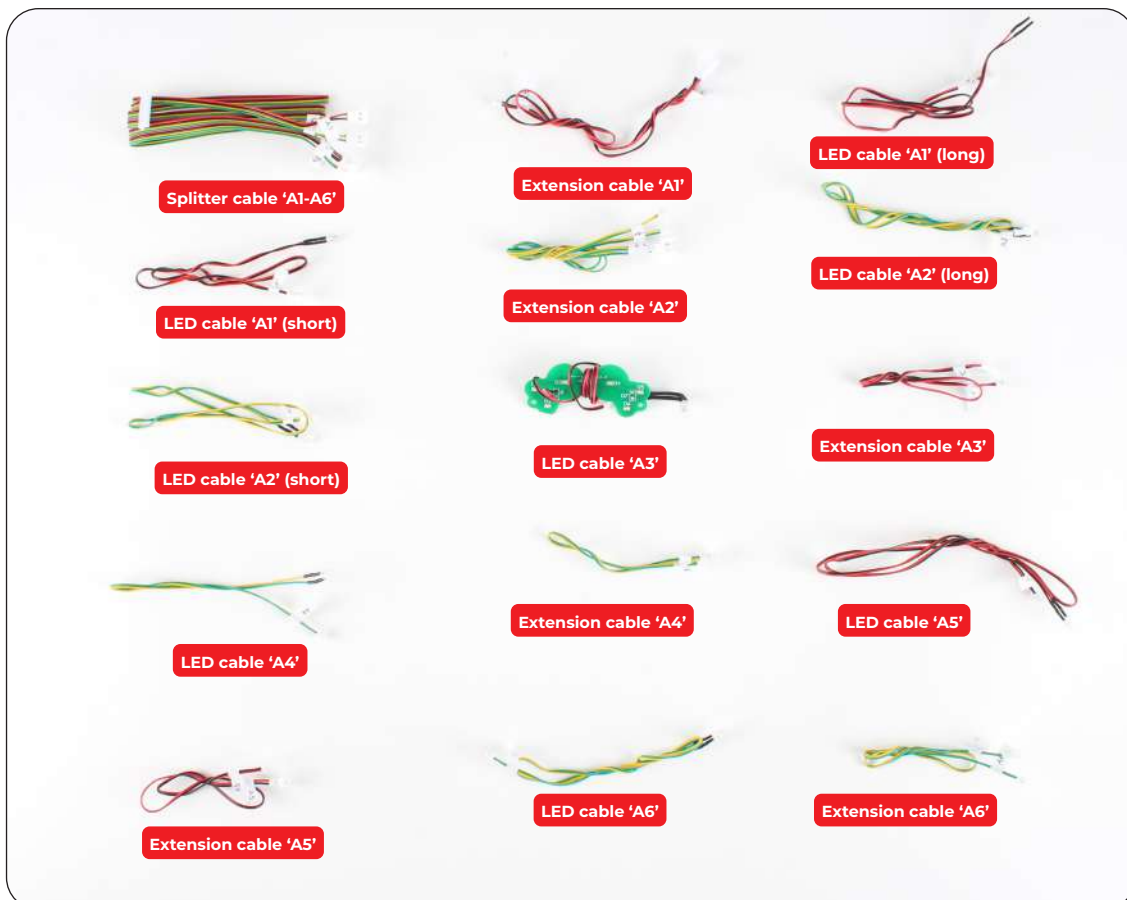

Stage 51: Connecting the First LED Cables

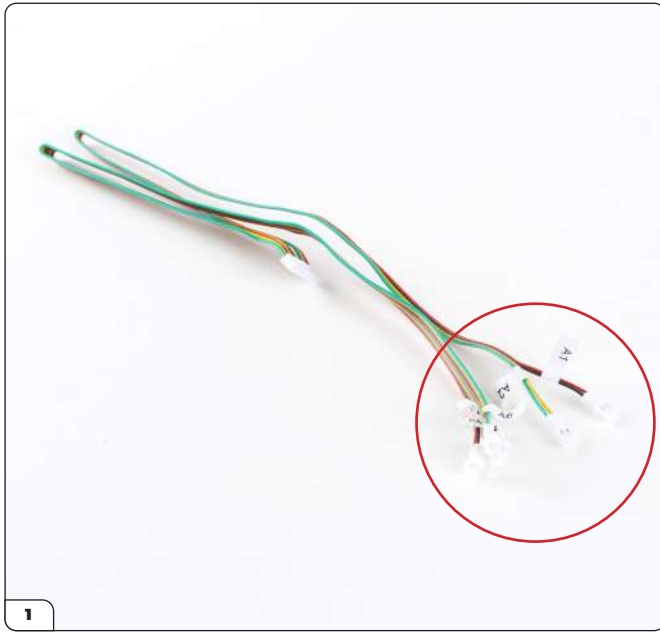

Take the splitter cable which has six plugs marked from 'A1' through to 'A6'.

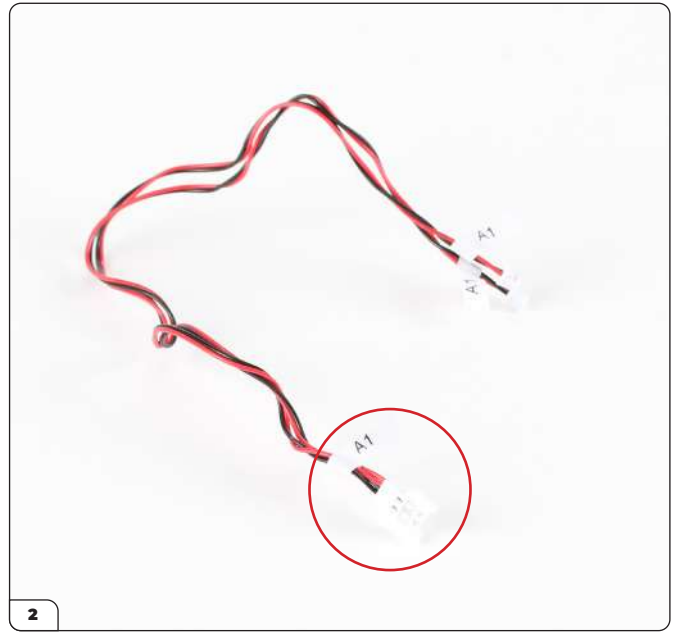

The process for connecting the cables will be to connect the labelled extension cable socket to the corresponding splitter cable plug. You'll then connect the LED cable(s) to the extension cable. Take extension cable 'A1'.

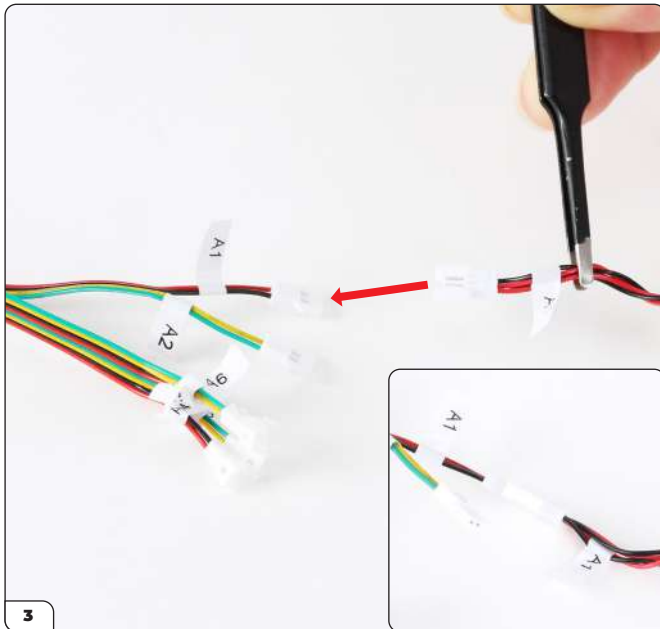

Connect extension cable 'A1' to the splitter cable.

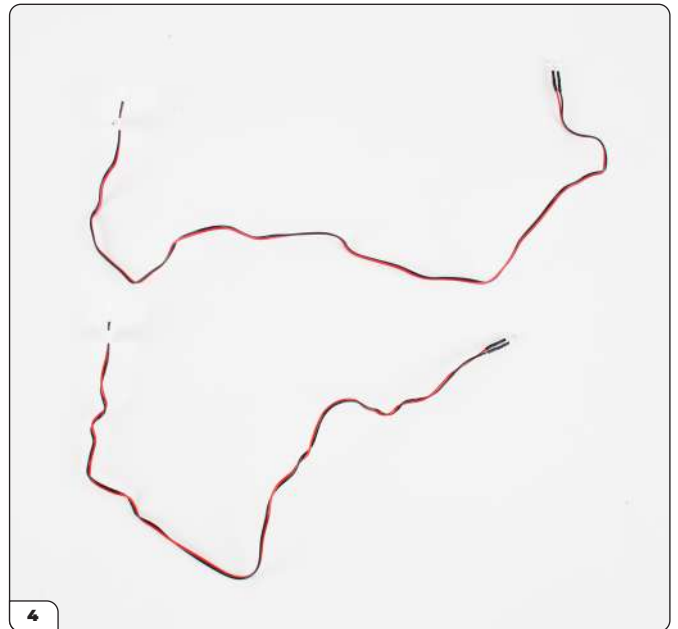

Take the LED cables 'A1'. One is longer than the other, but they can be plugged into either socket on the extension cable.

Stage 51: Connecting the First LED Cables

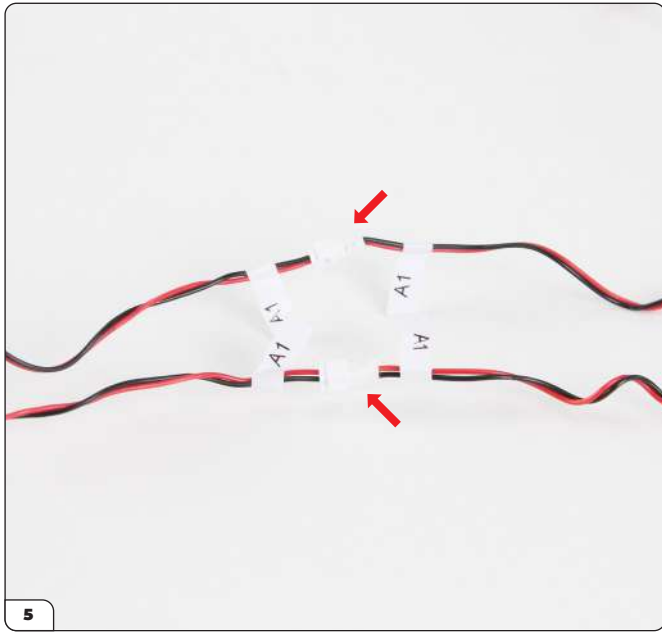

Plug the two LED cables into the extension cable sockets (all labelled with 'A1').



The cables should look like this.

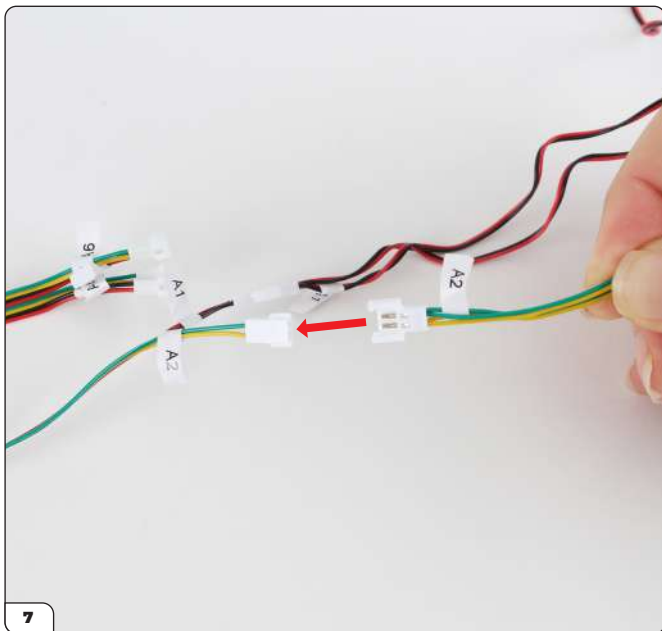

Plug extension cable 'A2' into the splitter.

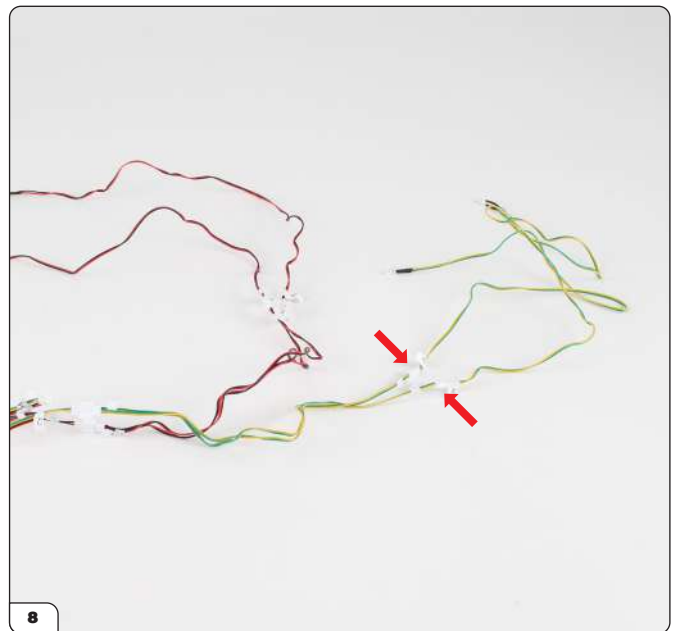

Plug the two LED cables 'A2' into their extension cable.

Stage 51: Connecting the First LED Cables

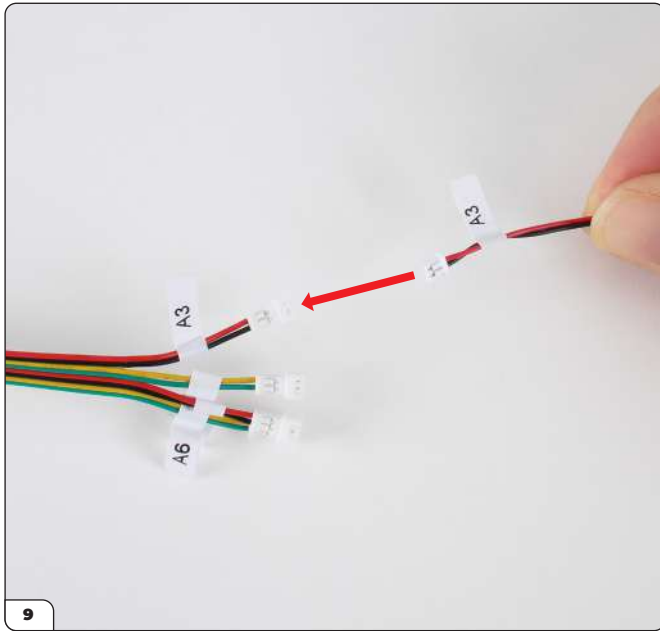

Plug extension cable 'A3' into the splitter.

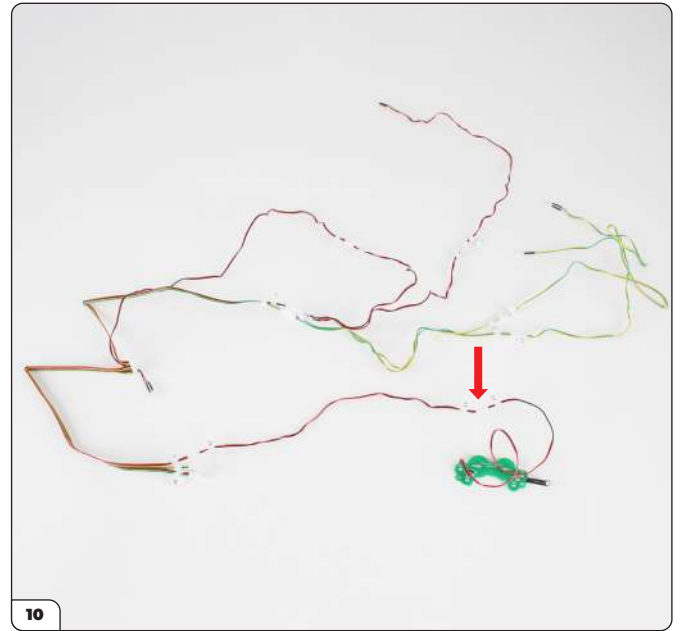

Plug LED cable 'A3' into its extension.

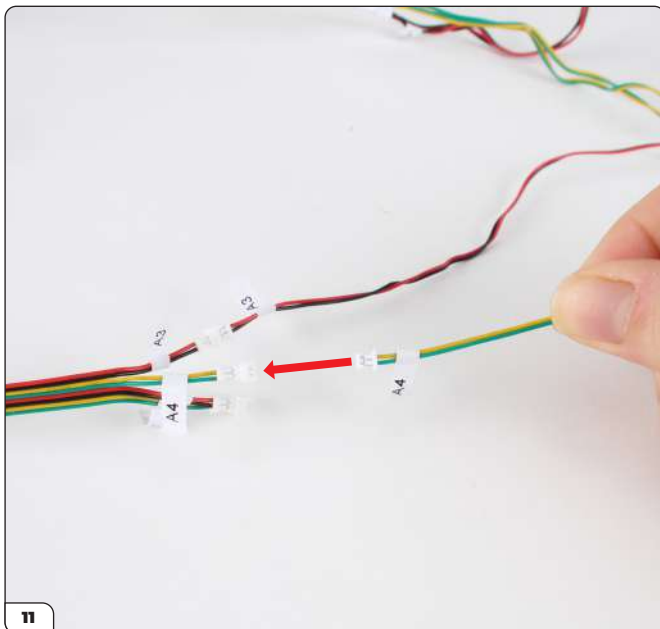

Plug extension cable 'A4' into the splitter.

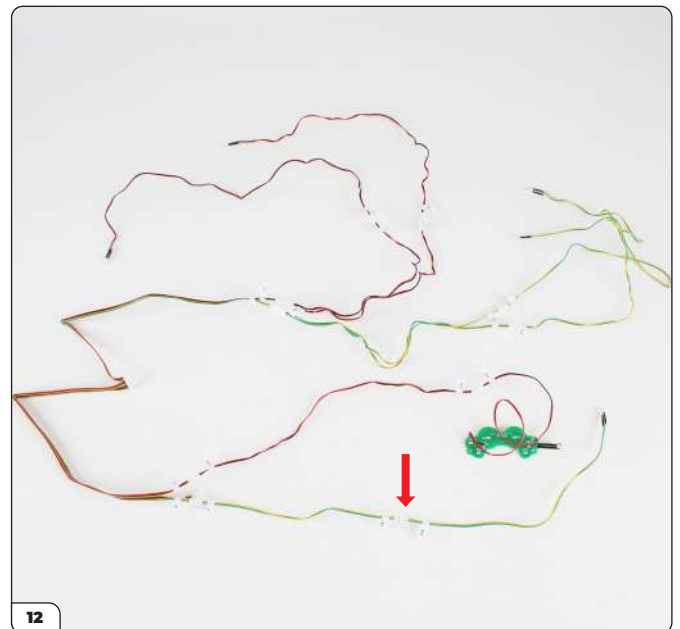

Plug LED cable 'A4' into its extension.

Stage 51: Connecting the First LED Cables

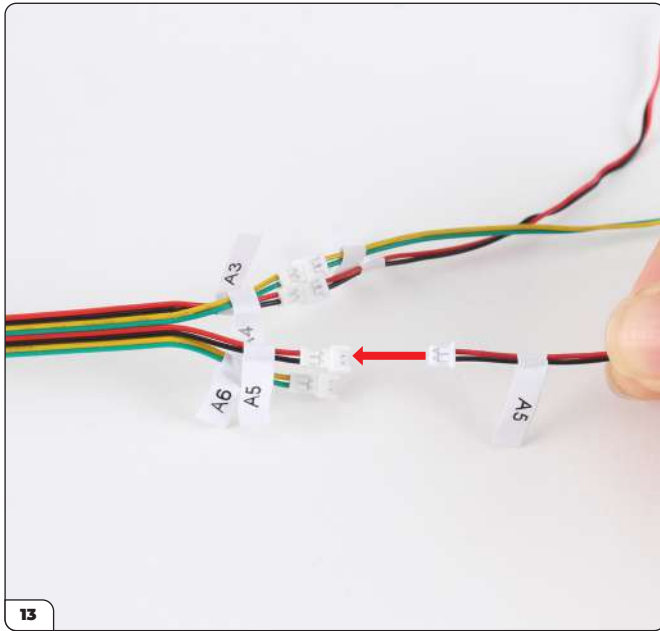

Plug extension cable 'A5' into the splitter.

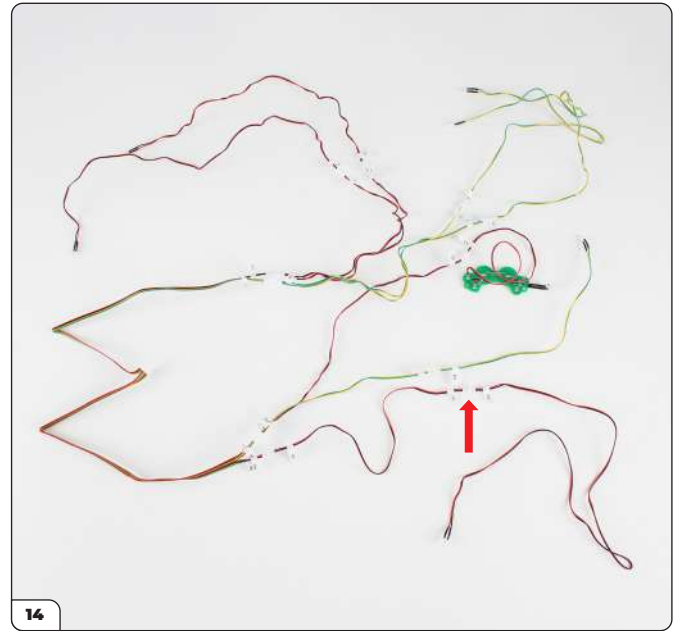

Plug LED cable 'A5' into its extension.

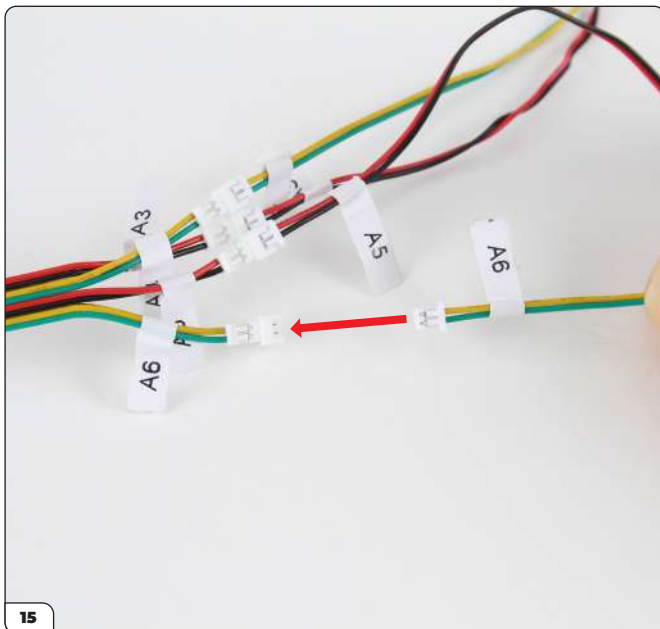

Plug extension cable 'A6' into the splitter.

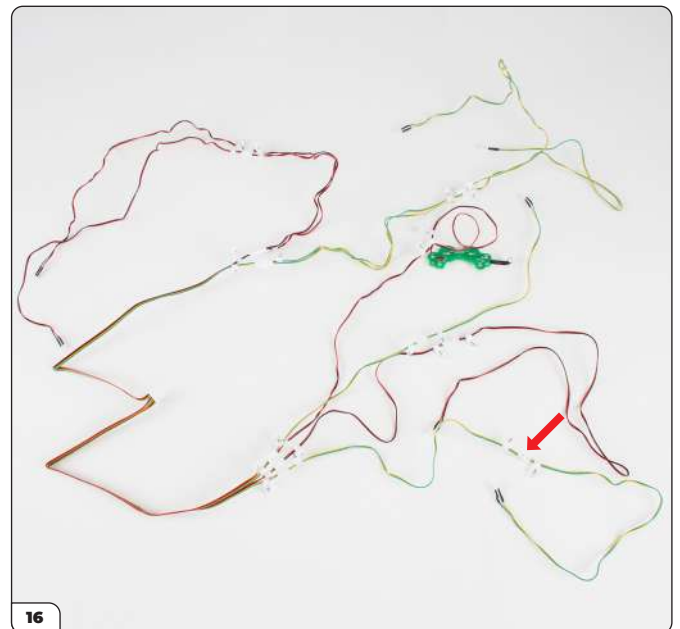

Plug LED cable 'A6' into its extension.

Stage 51: Connecting the First LED Cables

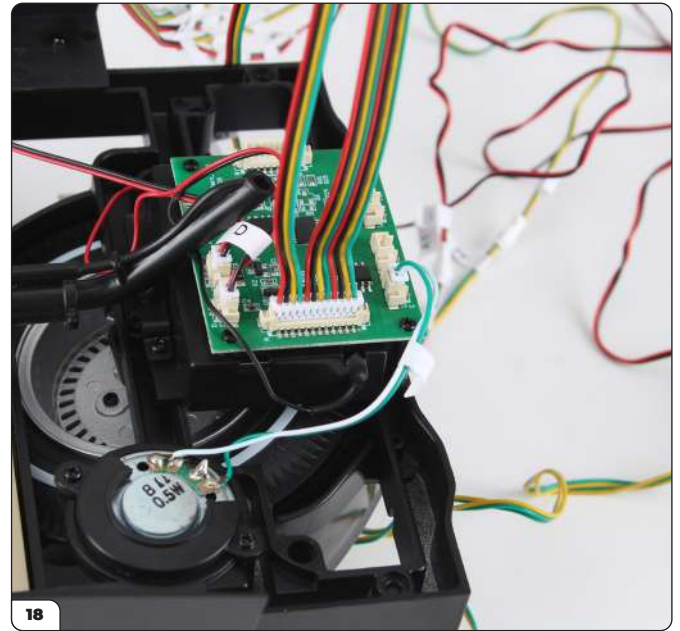
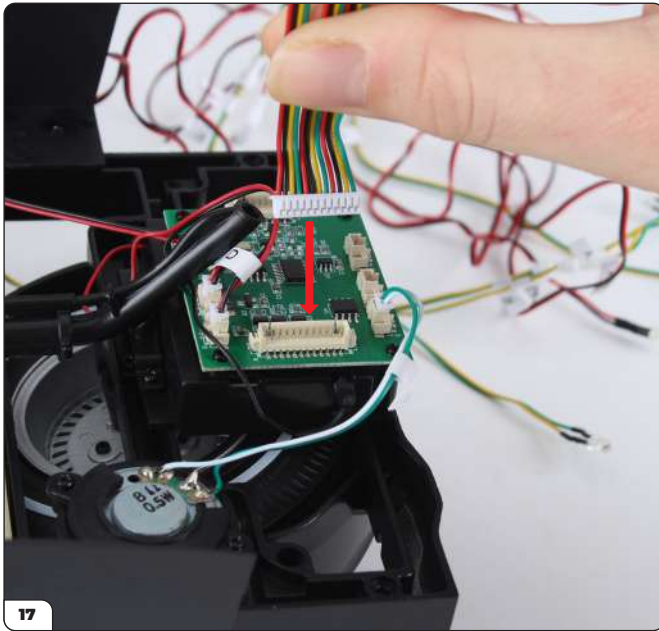

Fit the splitter cable plug into the circuit board socket marked 'A'.

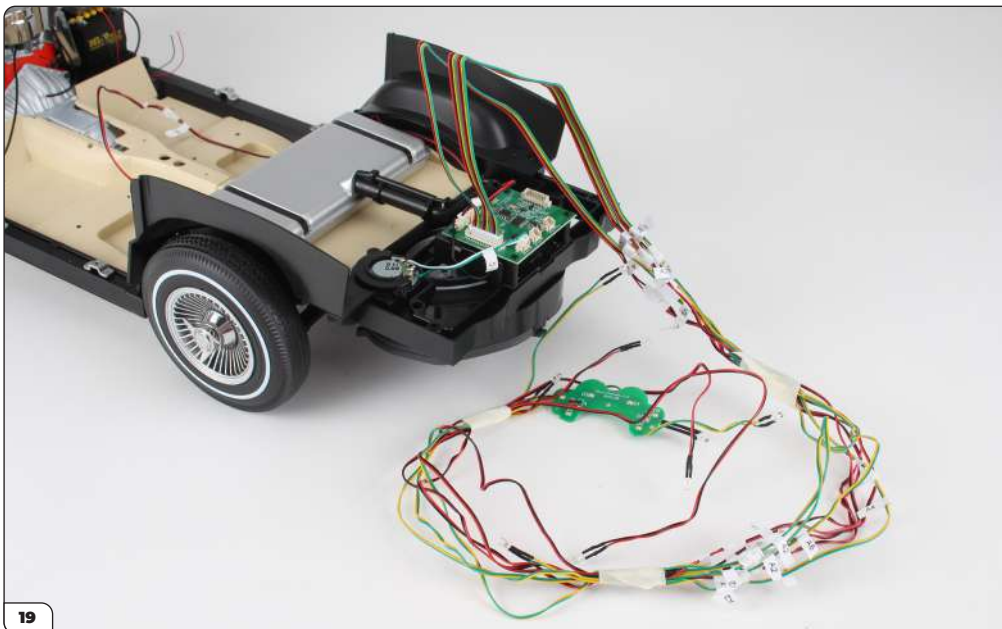

When storing the model away, bundle the cables together and secure with masking tape to avoid damaging them.

Stage 51: Connecting the First LED Cables

STAGE COMPLETE

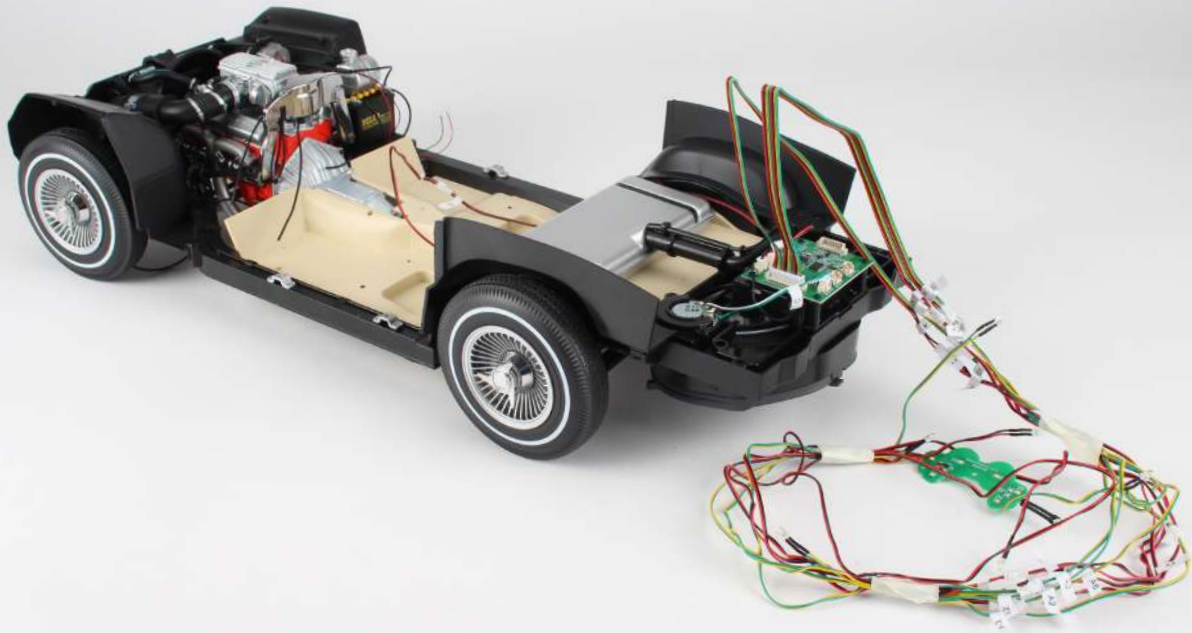

Stage 52: Connecting the Second LED Cables

You'll now connect the second set of LED cables then plug them into the circuit board.



STAGE 52 PARTS LIST

Name
Splitter cable 'B1-B3'
LED cable 'B1'
LED cable 'B2'
LED cable 'B3'
Model stand x4

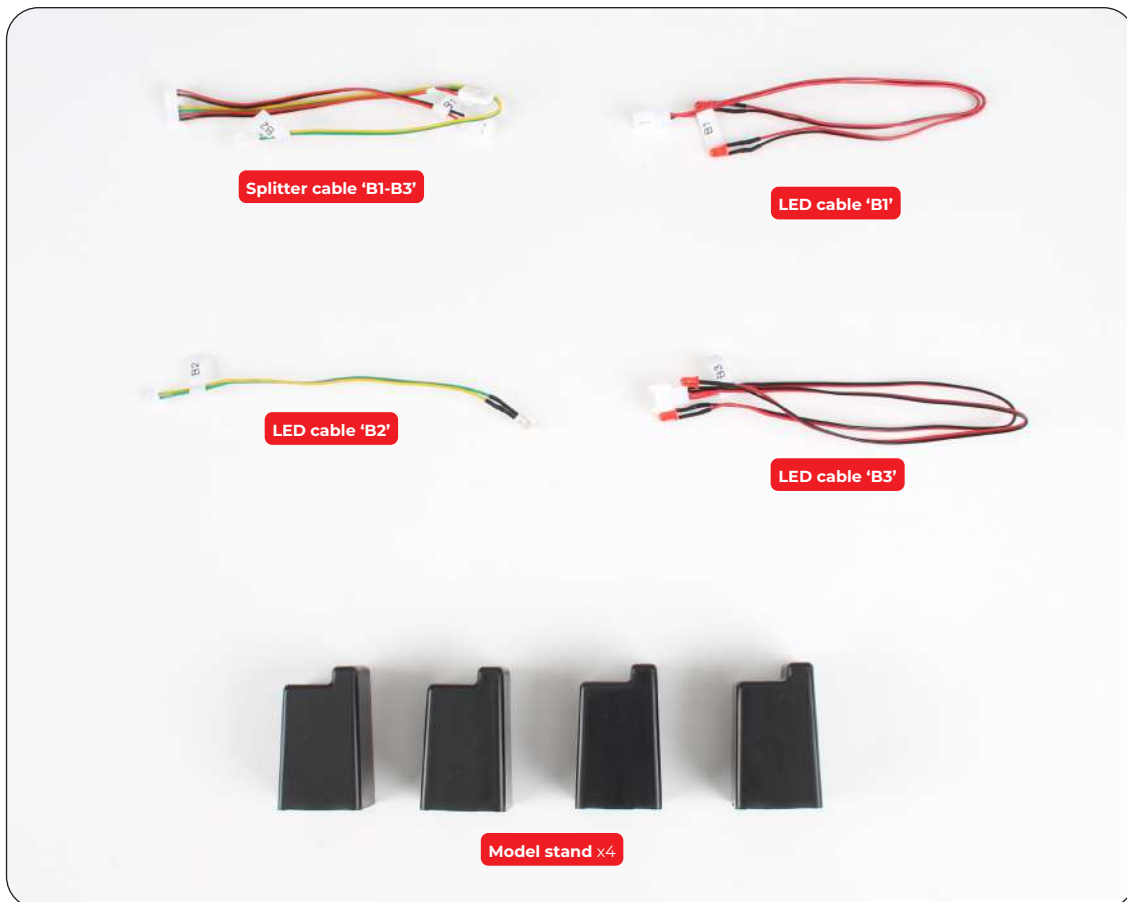

Stage 52: Connecting the Second LED Cables

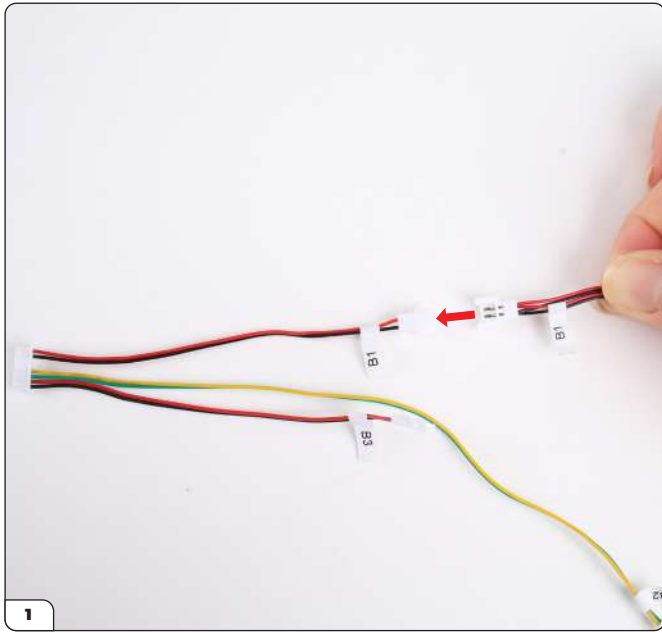

Connect the LED cable 'B1' to the corresponding splitter socket.

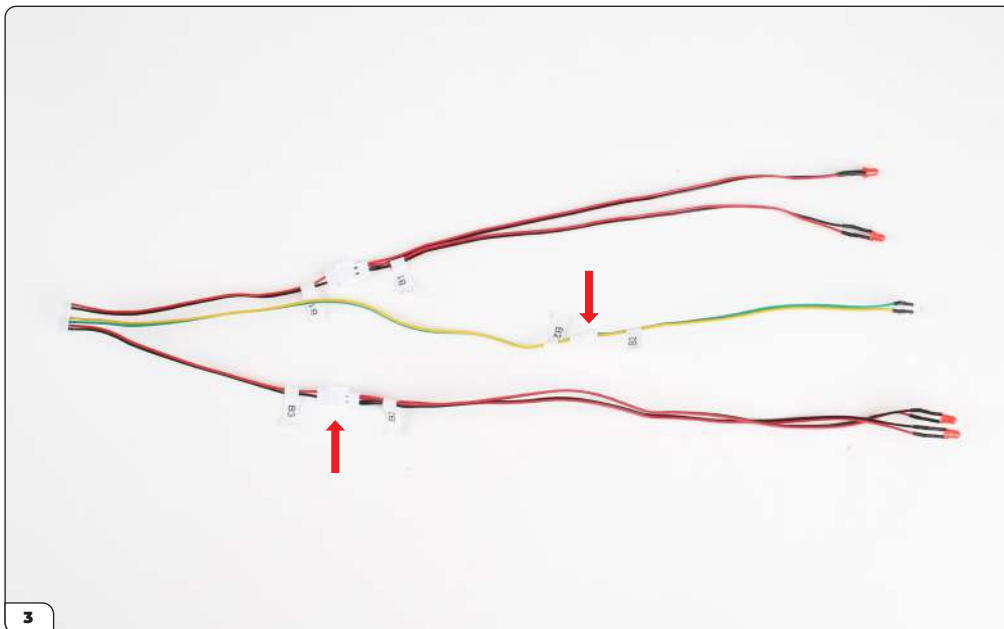

Connect the LED cables 'B2' and 'B3' to the splitter in the same way.

Stage 52: Connecting the Second LED Cables

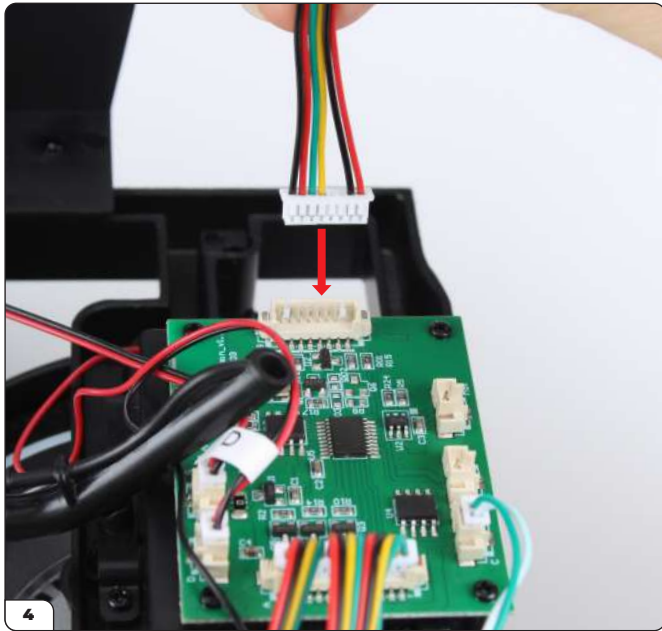

Plug the splitter into the circuit board socket marked 'B'.

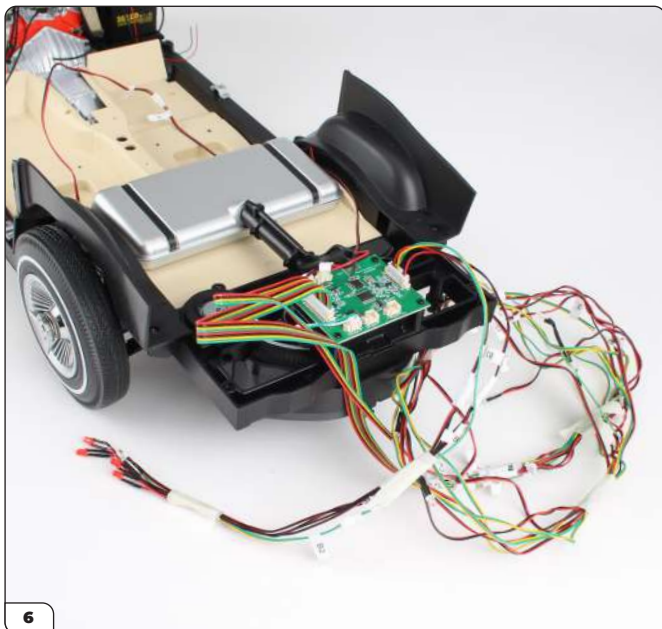
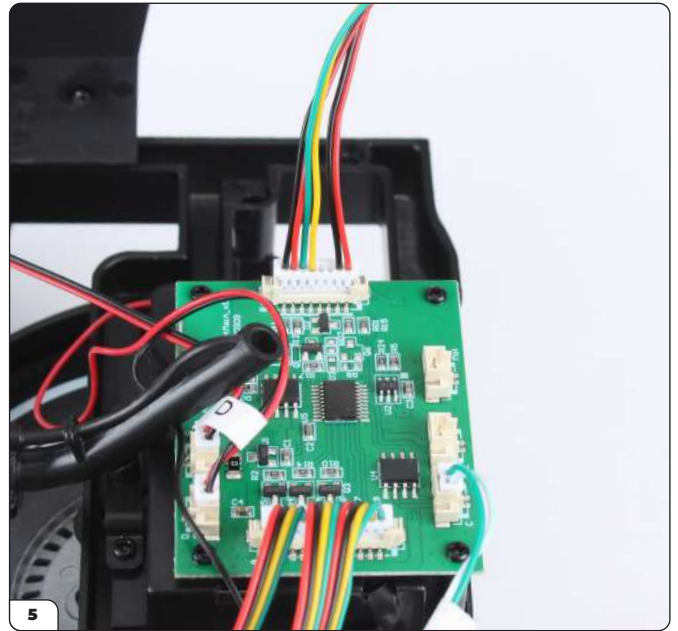

Like the previous set of cables, make sure to bundle these with masking tape when storing the model.



The four stands help support the model when displayed and allow the wheels to be turned easily. Store these away until the model is completed.

Stage 52: Connecting the Second LED Cables

STAGE COMPLETE

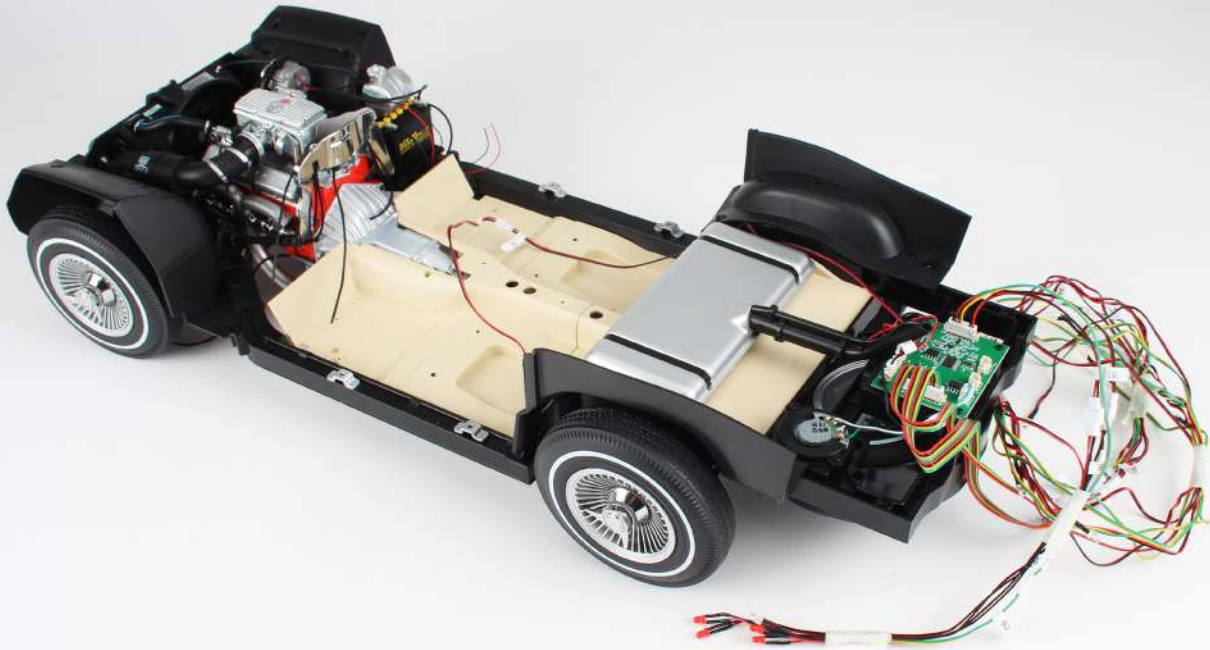

Stage 53: Building the Remote Control and Testing the Electronics

In this stage you'll build the remote control for your model, then install batteries and test the electronic functions.

You'll need 3x AAA and 1x CR2032 batteries for this stage.



STAGE 53 PARTS LIST

Name
Remote control back
Remote control front
Circuit board
Keypad
Battery tray
OP screws x2



Stage 53: Building the Remote Control and Testing the Electronics



Fit the keypad into the remote control front, using the column as a guide (circled).

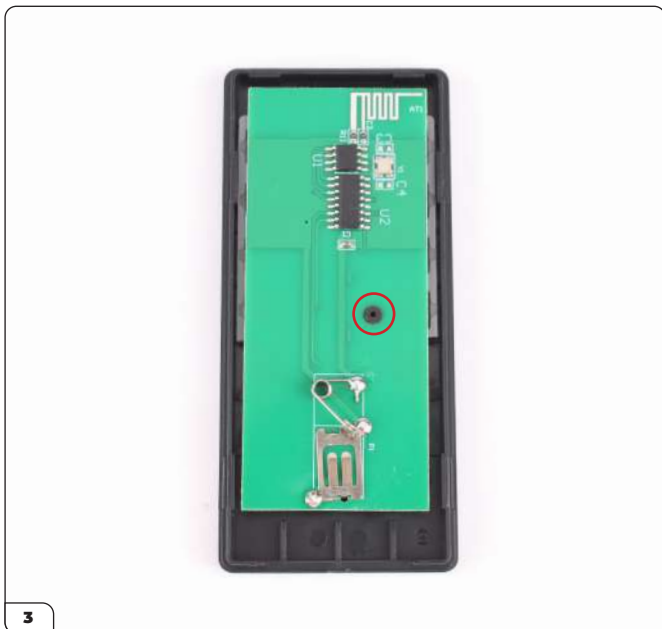

Place the circuit board over the keyboard as shown, fitting the hole over the column.

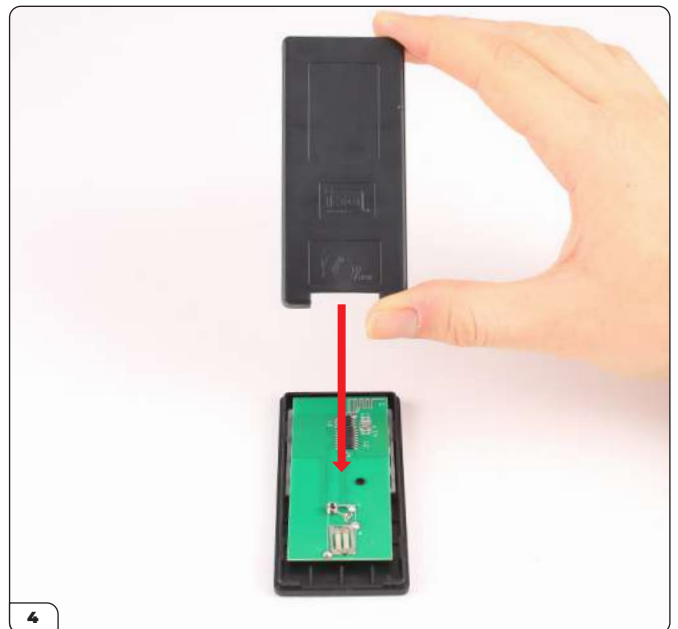

Align the remote control back as shown.

Stage 53: Building the Remote Control and Testing the Electronics



Press the back onto the front until it clicks in place.



Align the battery tray with the remote control, then fit a CR2032 battery into the tray with the positive (+) side face-up (inset).



Push the battery tray into the remote control.



Stage 53: Building the Remote Control and Testing the Electronics



Button	Function
1	Turn off all light and sound functions
2	Increase volume
3	Decrease volume
4	Start ignition sound
5	Play acceleration sound
6	Play horn sound
7	Headlights up/down
8	Cycle through headlights
9	Turn interior light on/off
10	Turn left turn signal lights on/off
11	Turn right turn signal lights on/off
12	Turn on stoplights (hold button)

The remote control has been assembled. The table opposite shows the function of the buttons.

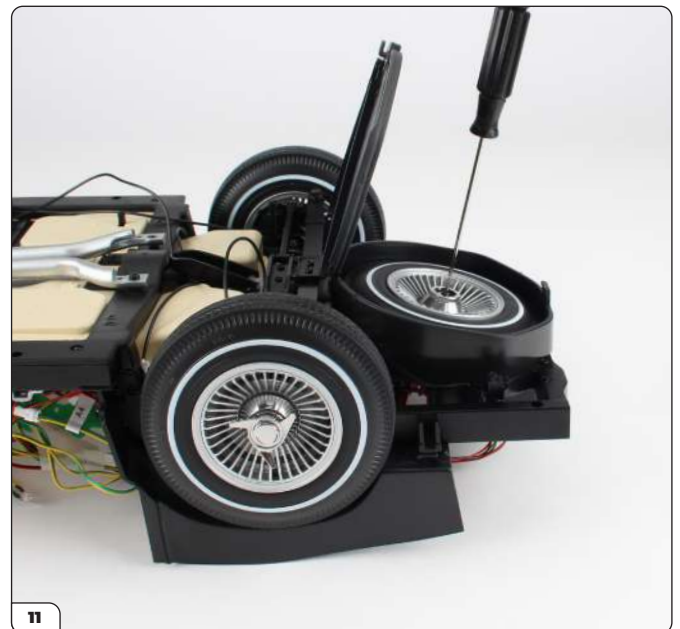

Carefully place the main assembly upside down on your work surface and open the spare wheel lid.

Unscrew the washer and IP screw holding the spare wheel in place. Keep the washer in a safe place.

Stage 53: Building the Remote Control and Testing the Electronics



Using a screwdriver or similar tool, lift the spare wheel out of the holder and place it aside.

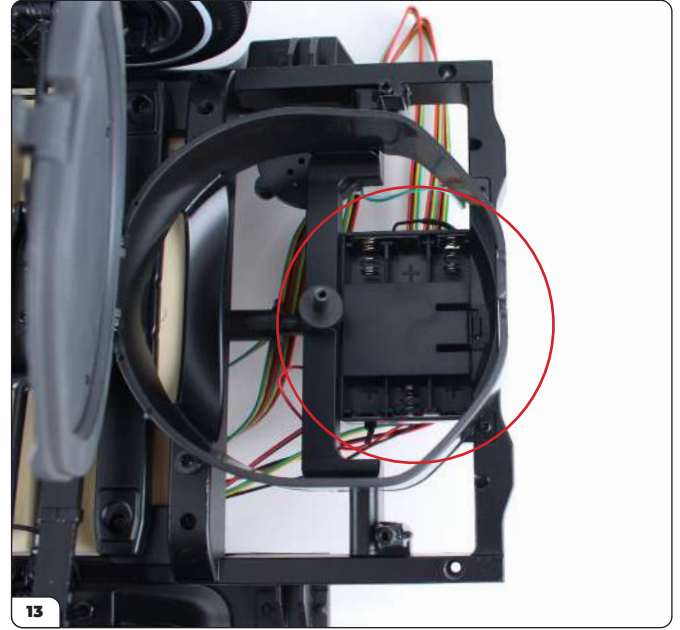

With the spare wheel removed you can access the battery compartment.

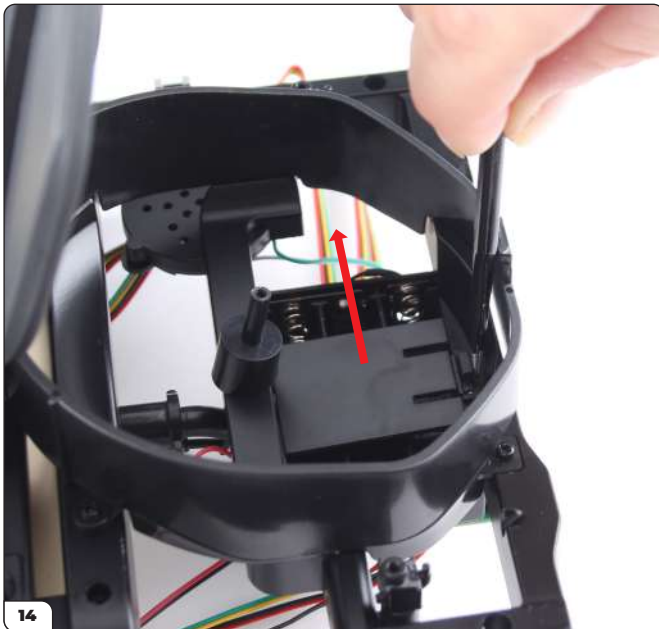

Use tweezers to apply pressure to the clip and remove the battery compartment cover.

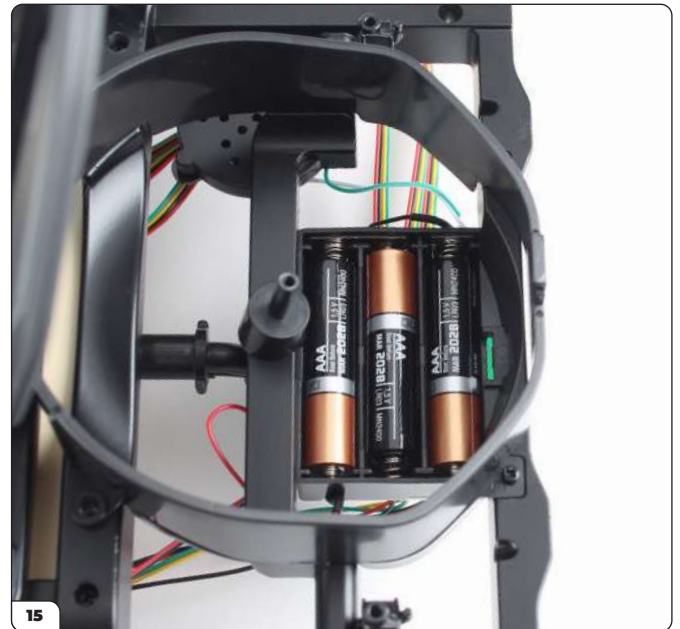

Fit 3x AAA batteries into the compartment, following the markings printed on the compartment for '+' and '-'.

Stage 53: Building the Remote Control and Testing the Electronics

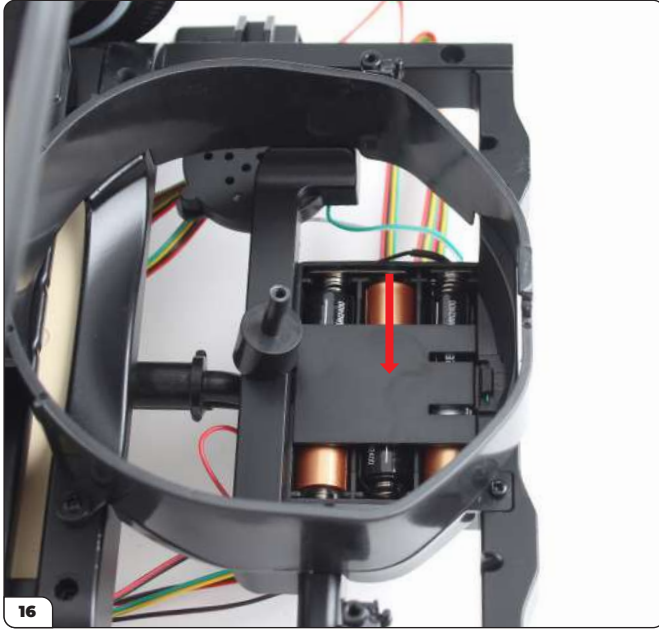

Fit the battery compartment cover back in place.

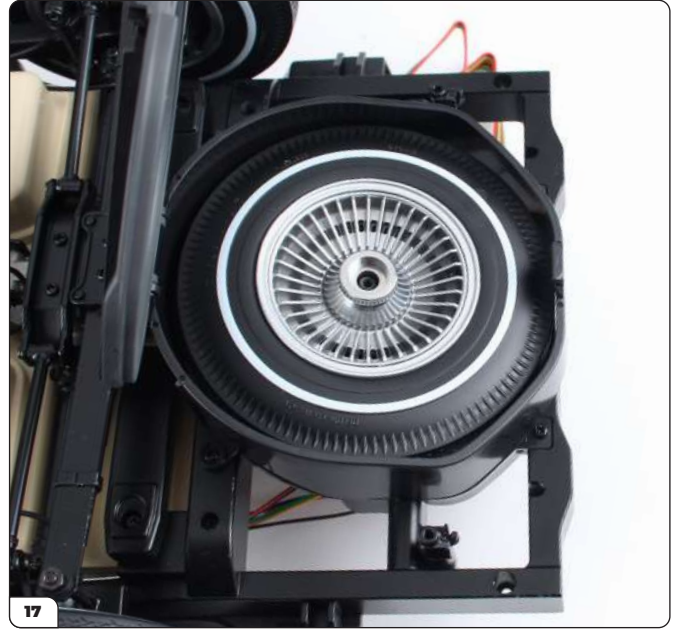

Position the spare wheel back in the holder.

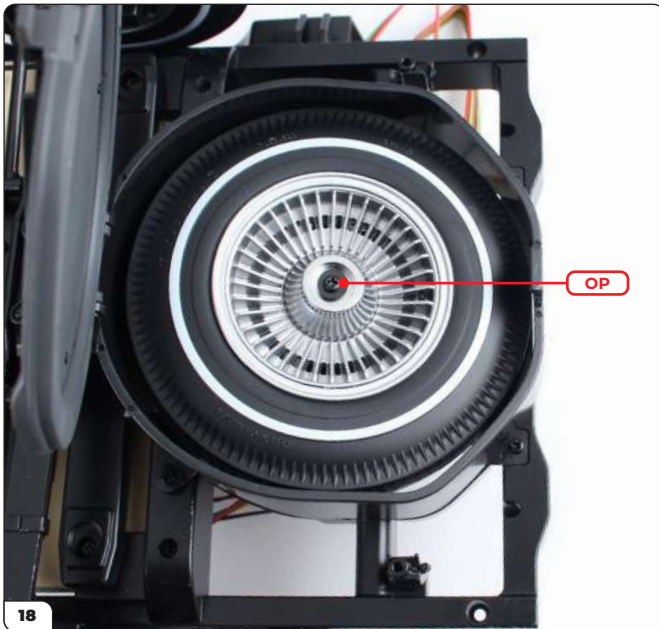

Replace the washer removed in step 11 then secure the wheel using an OP screw provided with this stage.

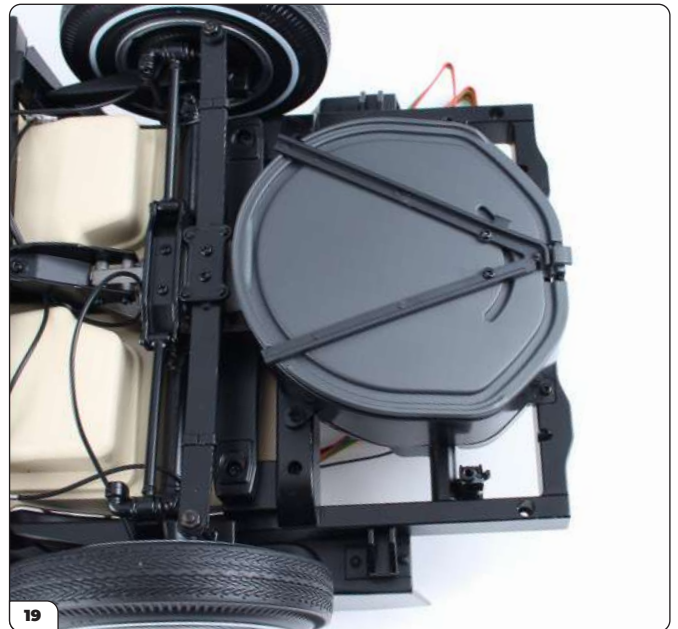

Close the spare wheel holder lid.

Stage 53: Building the Remote Control and Testing the Electronics

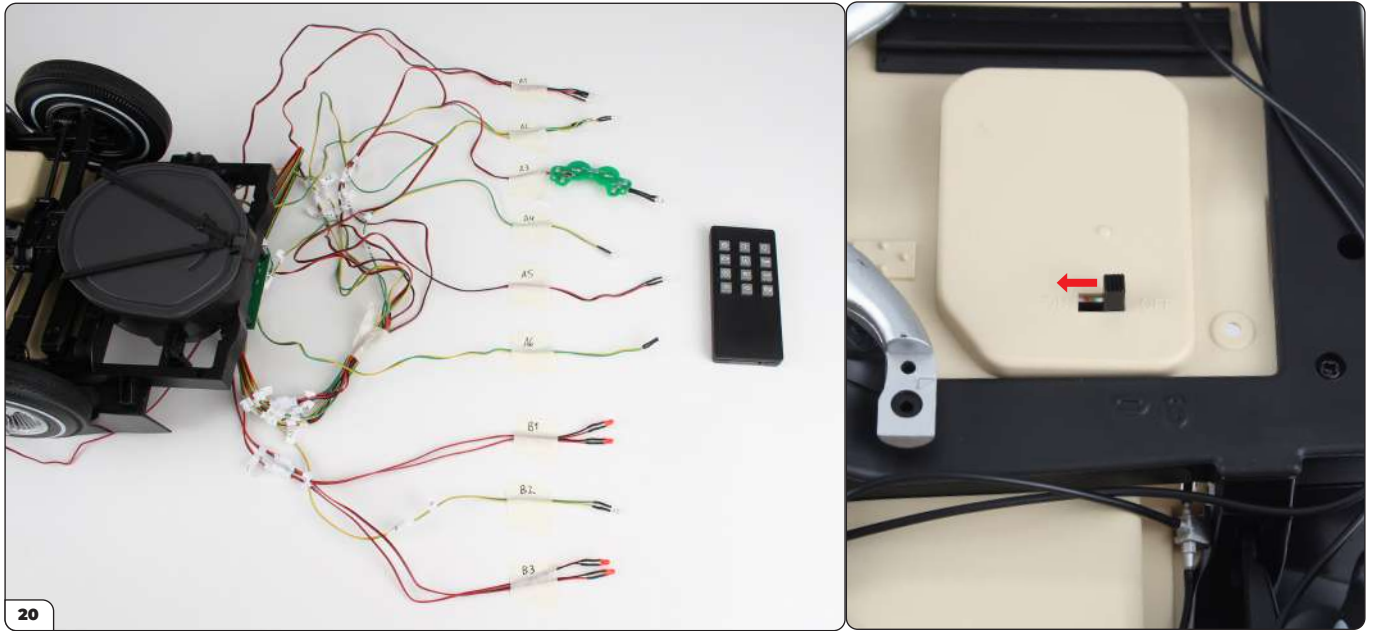

To test the electrics, clearly mark the LEDs with their label on a piece of masking tape to help identify them easily. It will also help to turn the lights down low! Remember to turn the power switch from 'OFF' to 'ON'.

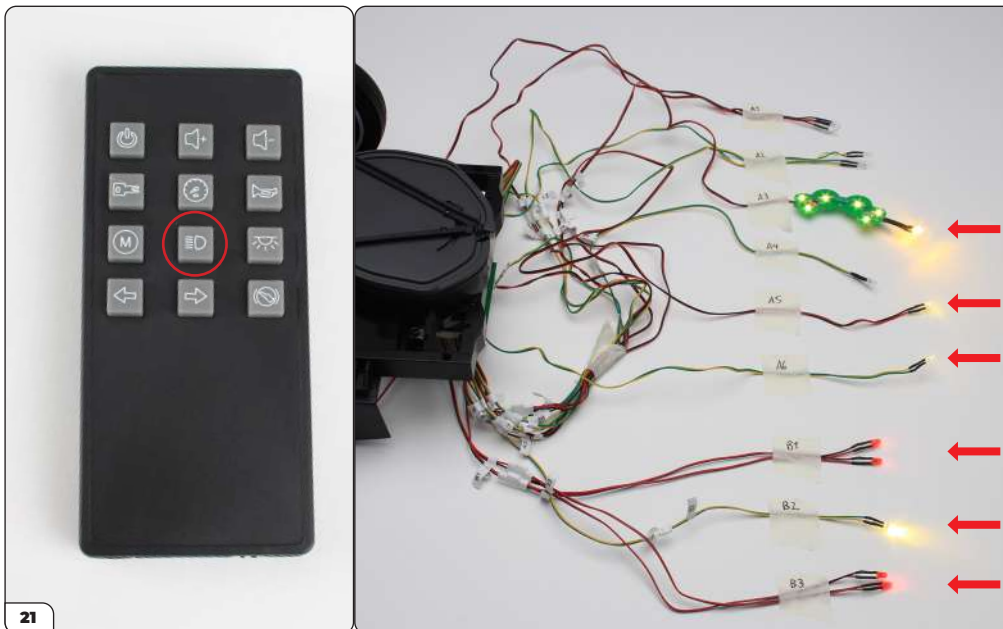

Press the Headlights button once. The LEDs of A3, A5, A6, B1, B2 and B3 should light up.

Stage 53: Building the Remote Control and Testing the Electronics

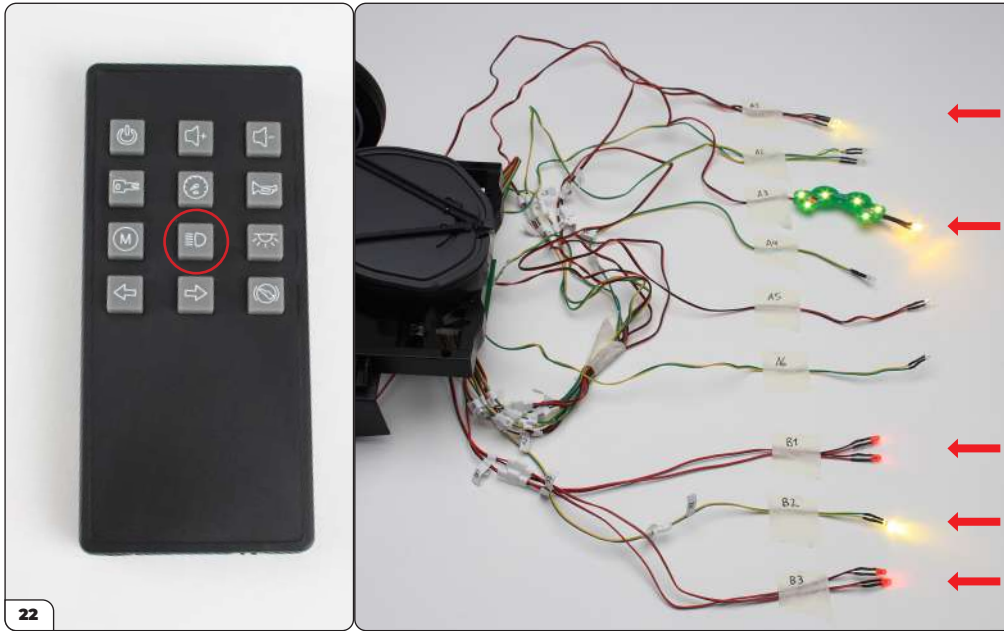

22

Press the Headlights button a second time. The LEDs of A1, A3, B1, B2 and B3 should be lit.

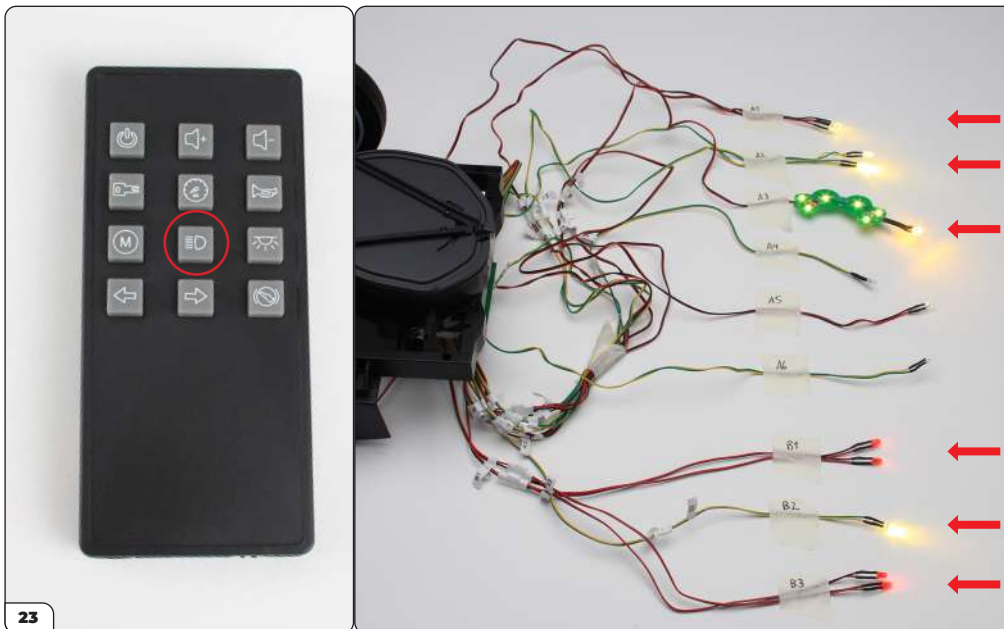

23

Press the Headlights button a third time. The LEDs of A1, A2, A3, B1, B2 and B3 should be lit.

Stage 53: Building the Remote Control and Testing the Electronics

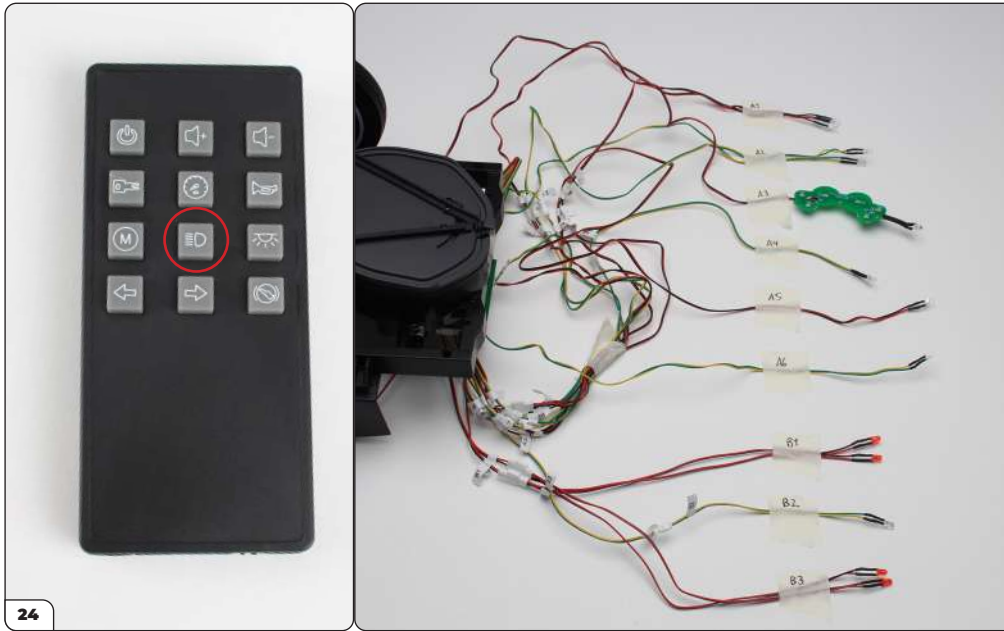

Press the Headlights button a fourth time. All LEDs should turn off.

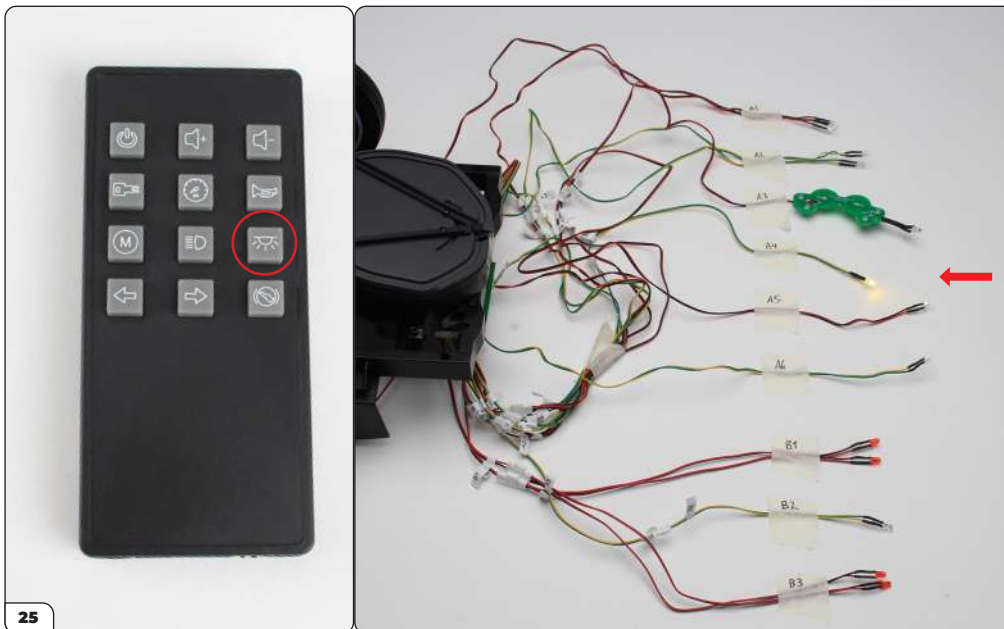

Next press the Interior Light button. LED A4 should light up. Press the interior light button again and the LED should turn off.

Stage 53: Building the Remote Control and Testing the Electronics

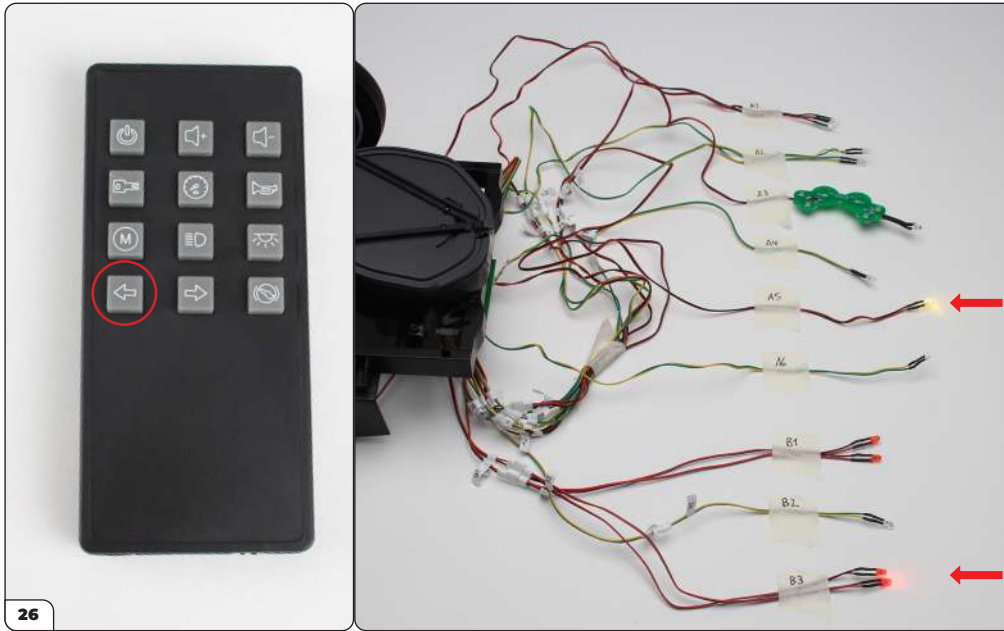

Next press the Left Turn Signal button. LEDs A5 and B3 should start flashing. Press the button again and the LEDs should turn off.

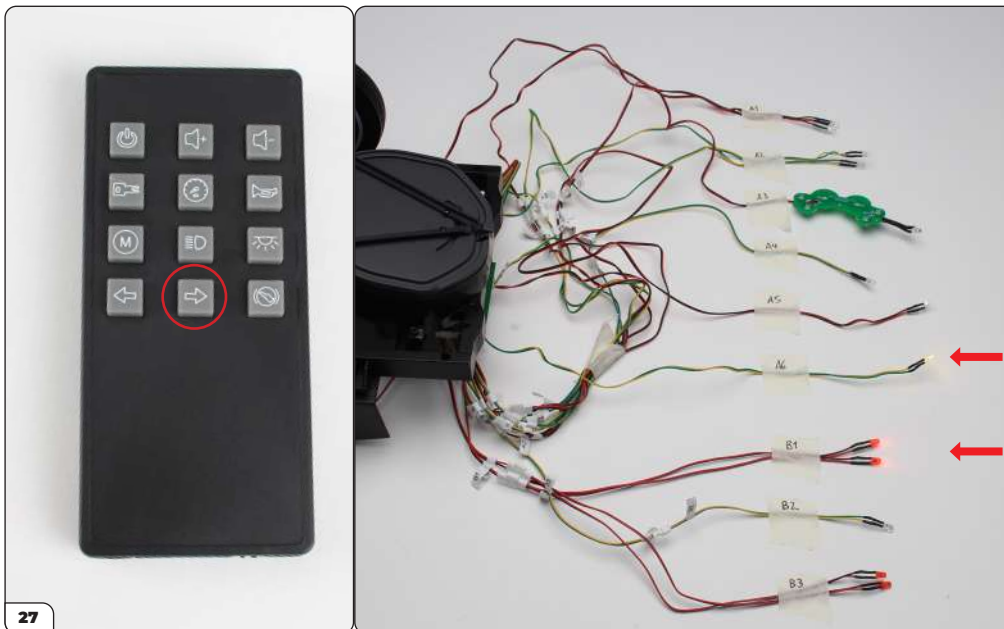

Next press the Right Turn Signal button. LEDs A6 and B1 should start flashing. Press the button again and the LEDs should turn off.

Stage 53: Building the Remote Control and Testing the Electronics

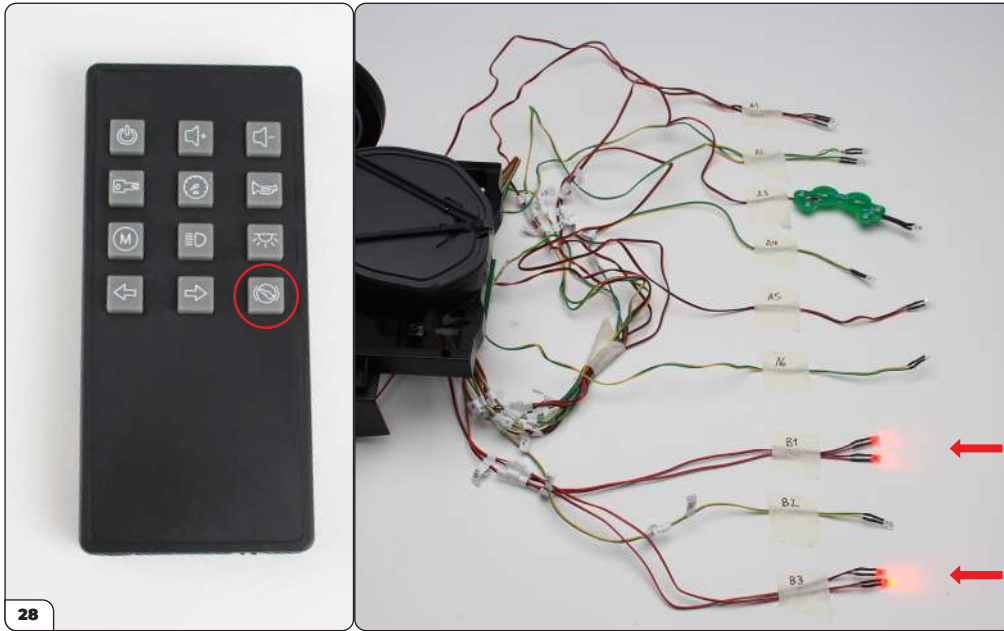

28

Press and hold the Stoplights button. LEDs B1 and B3 should light up. Release the button and the LEDs will turn off.

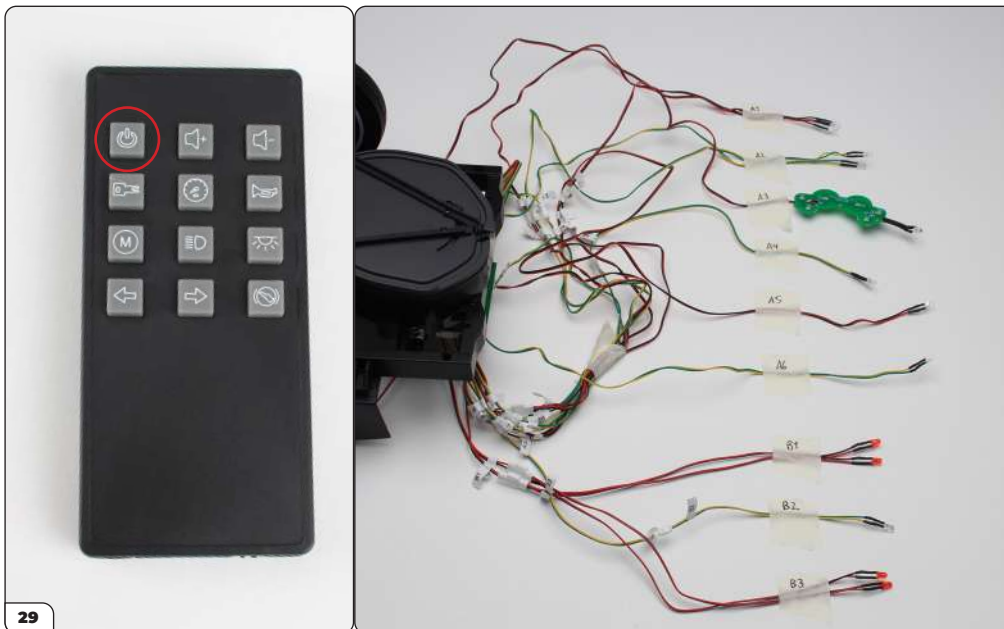

29

Press the Headlights button (as in step 21) to turn on the LEDs, then press the Off button – the LEDs should turn off. This button can be used to stop all electrical functions on the model.

Stage 53: Building the Remote Control and Testing the Electronics



Now test the sound of your model. Press the Ignition button – the ignition sound should start playing.



Press the Volume Up/Down buttons to increase or decrease the volume of the sound.



While the ignition sound is playing, hold the Acceleration button – the acceleration sound will play while it is held. This sound will not play unless the ignition has started.



Press the Horn button to sound the horn.

Stage 53: Building the Remote Control and Testing the Electronics



Press the Off button to stop all sound playing.



After testing the electrical functions, remember to switch the power from 'ON' to 'OFF'.

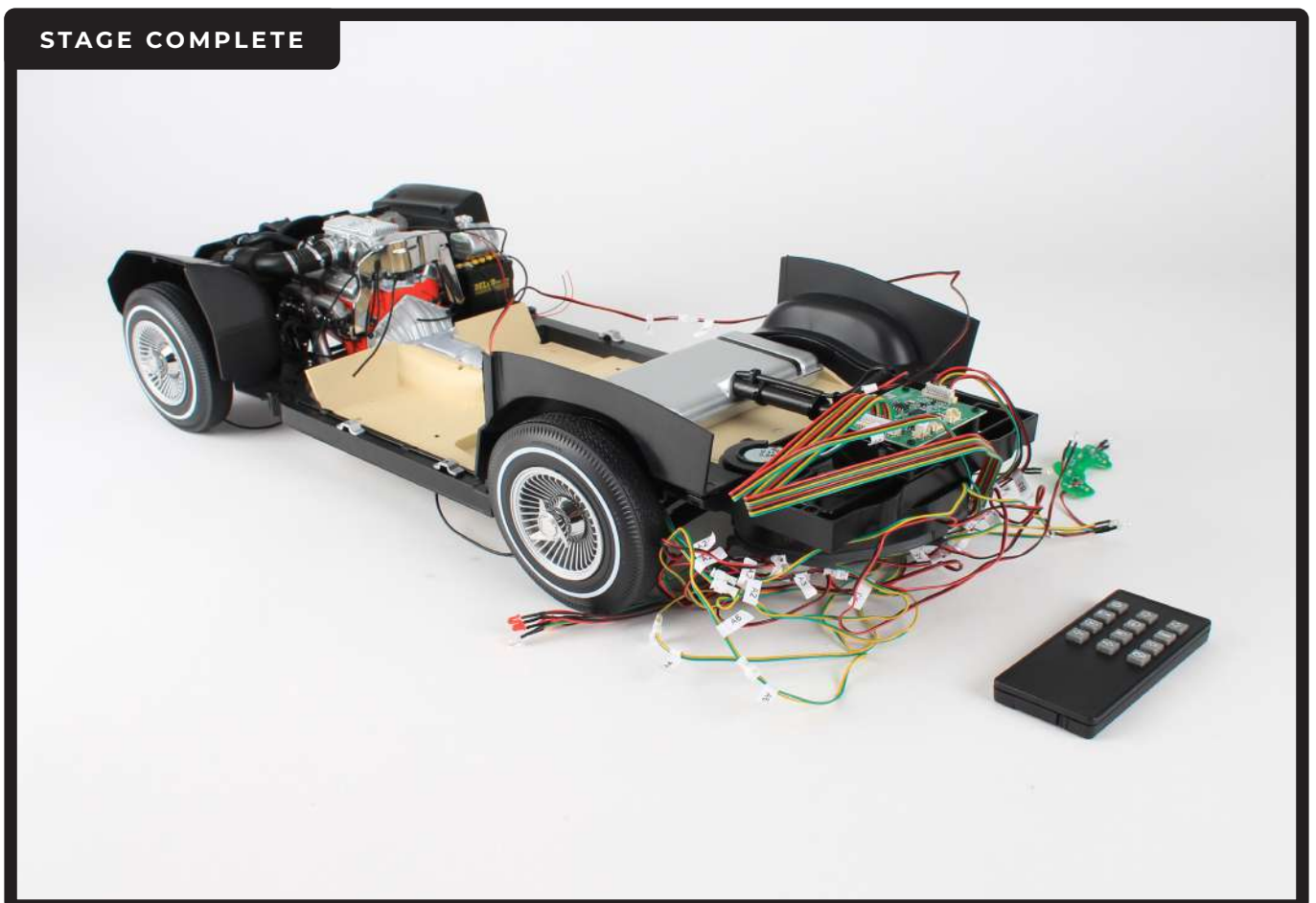

Stage 54: Applying Carpet to the Interior Floor

Next you'll begin to prepare the interior of your model by applying the luxurious red carpet to the floor and transmission tunnel.



STAGE 54 PARTS LIST

Name
Interior floor
Floor carpet (left)
Floor carpet (right)
Transmission tunnel carpet (left)
Transmission tunnel carpet (right)

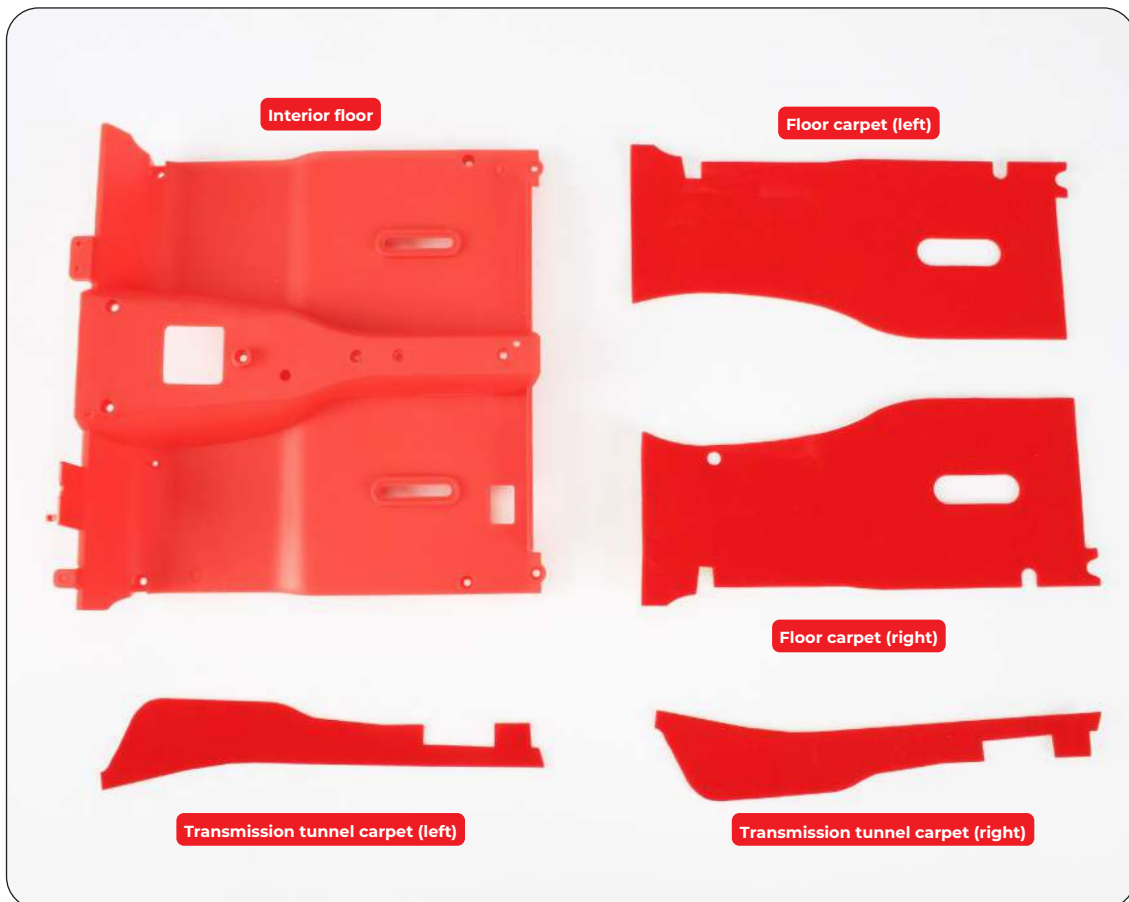

Stage 54: Applying Carpet to the Interior Floor



Whenever fitting the sections of carpet to your model, test fit the pieces first before removing their adhesive backing. This will help to fit the pieces together smoothly.

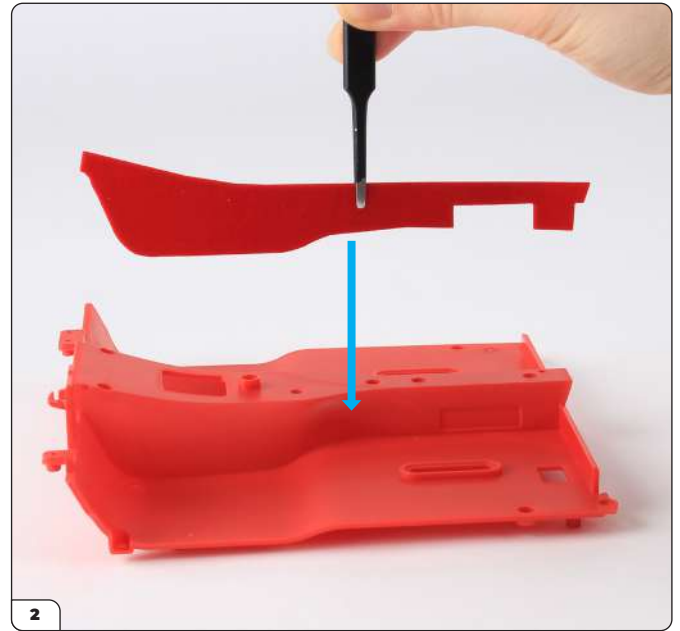

Align the right transmission tunnel carpet with the interior floor.

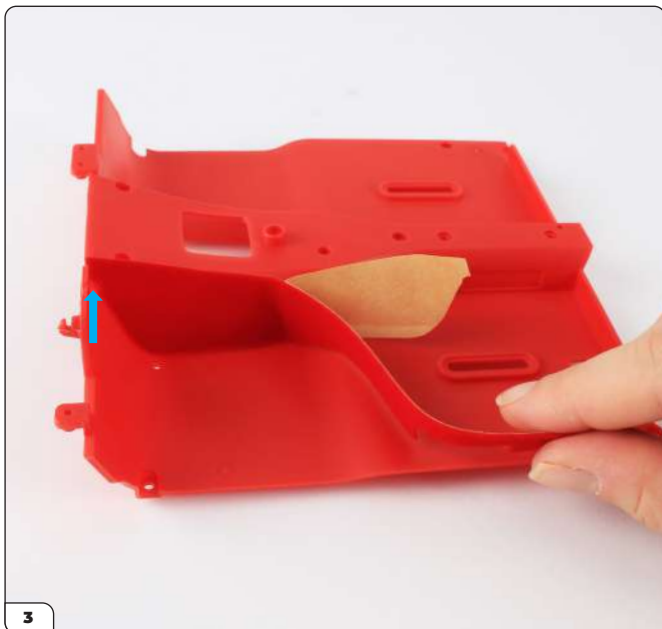

Starting at one end, half-peel the backing paper from the carpet piece and smoothly apply it to the interior.



Continue to peel the backing paper while applying the piece, carefully stretching as needed to fit the carpet around the opening and to the end of the interior.

Stage 54: Applying Carpet to the Interior Floor



Apply the right floor carpet, half-peeling the backing paper and starting at one end in the same way.



As you apply the carpet, use tweezers to firmly press the edge that joins with the transmission tunnel carpet as indicated by the arrows.



Turn the interior around and apply the left transmission tunnel carpet in the same way as the right.



Fit the left floor carpet in the same way as the right, pressing firmly with tweezers to get a smooth edge.

Stage 54: Applying Carpet to the Interior Floor

STAGE COMPLETE

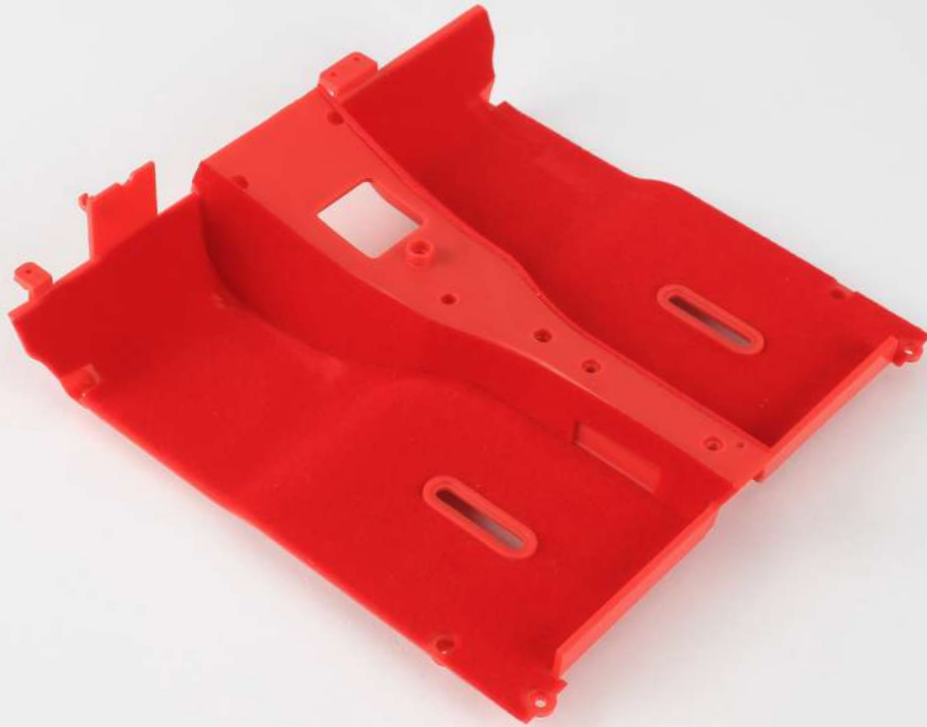

Stage 55: Applying Carpet to the Rear Left Side Panel

You'll now apply carpet then mount the rear left side panel onto the interior floor assembly.



STAGE 55 PARTS LIST

Name
Rear left side panel
Carpet 1
Carpet 2
Carpet 3
Carpet 4
Carpet 5
IP screw x2



Stage 55: Applying Carpet to the Rear Left Side Panel



Align carpet 2 with the rear left side panel.

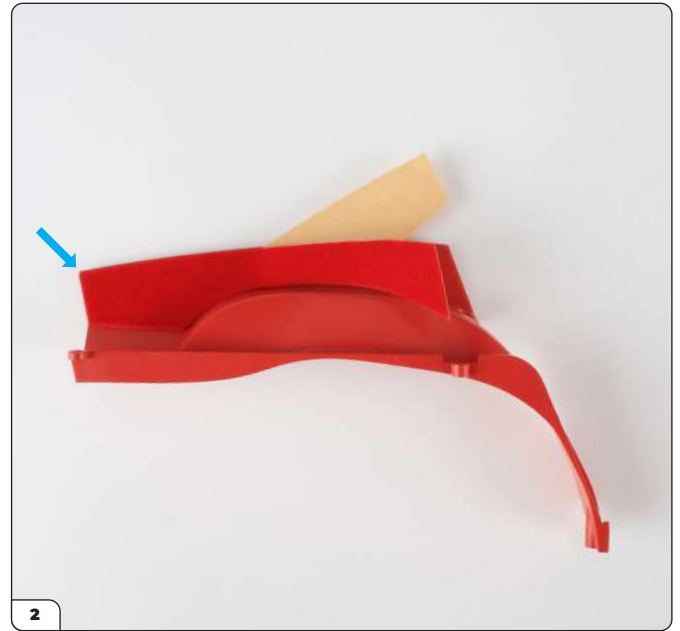

Half-peel the backing paper and smoothly apply the carpet starting from one end.



Continue to peel and apply the carpet to the other end.



Align carpet 3 with the side panel.

Stage 55: Applying Carpet to the Rear Left Side Panel

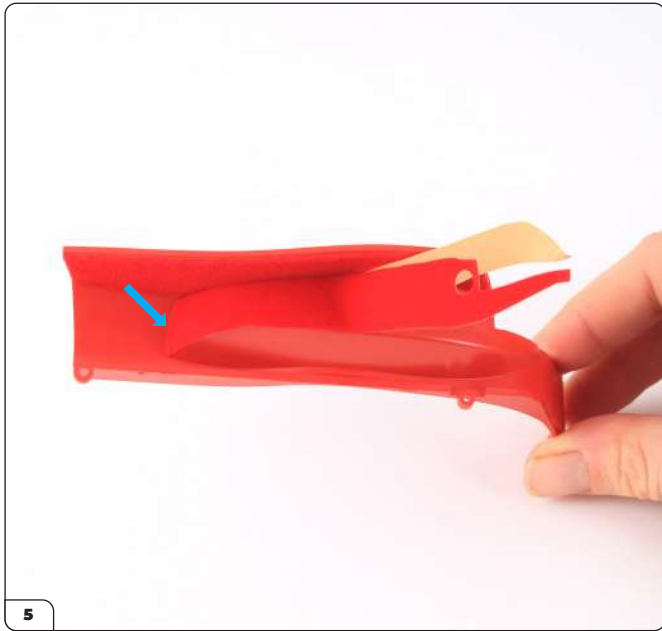

Start at one end and apply the carpet as shown.



Continue to apply the carpet, taking care with the alignment of the thinner end.

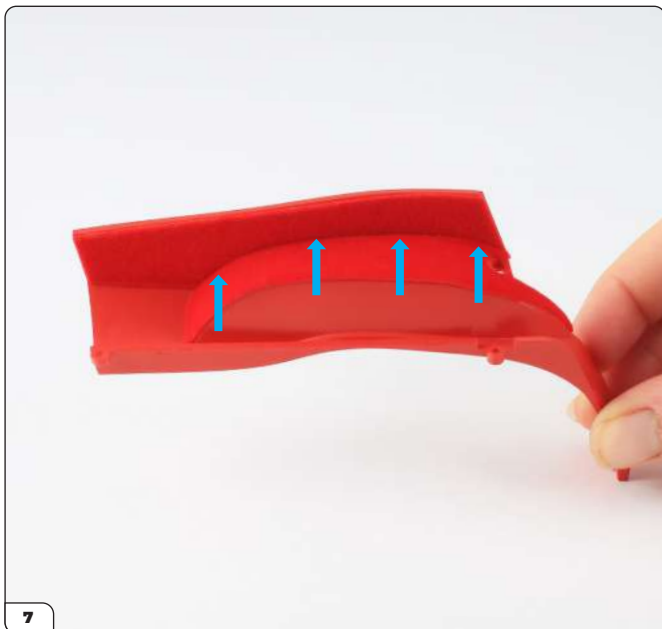

Press the joint of the edges firmly using tweezers.



Align carpet 1 with the side panel as shown.

Stage 55: Applying Carpet to the Rear Left Side Panel



Starting at the thinner end, apply the carpet to align the edge with carpet 3.

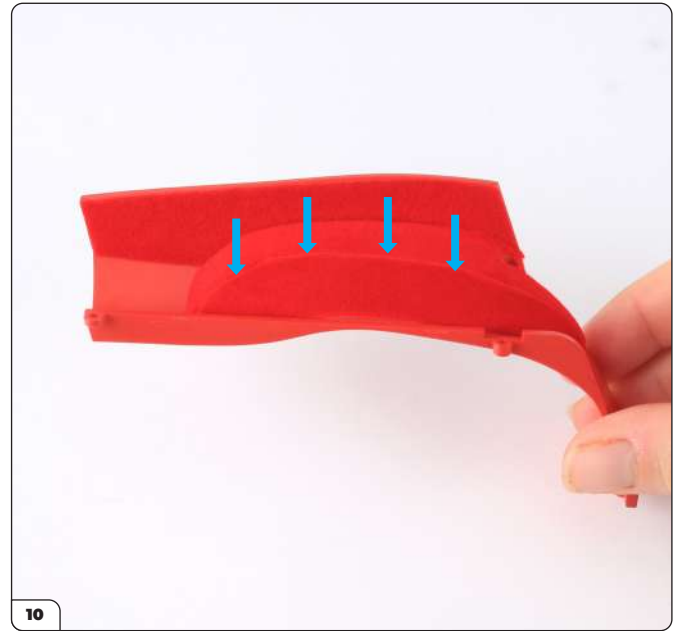

Continue to apply the carpet, pinching the joint with carpet 3 together.

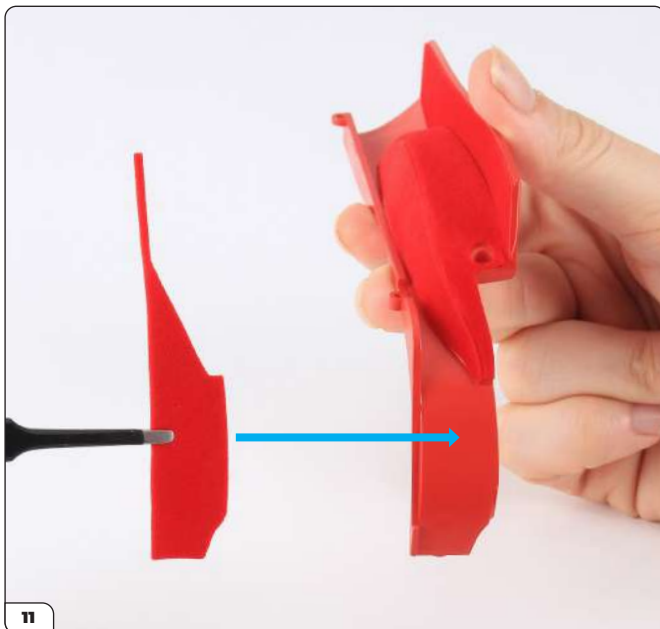

Align carpet 5 with the side panel as shown.

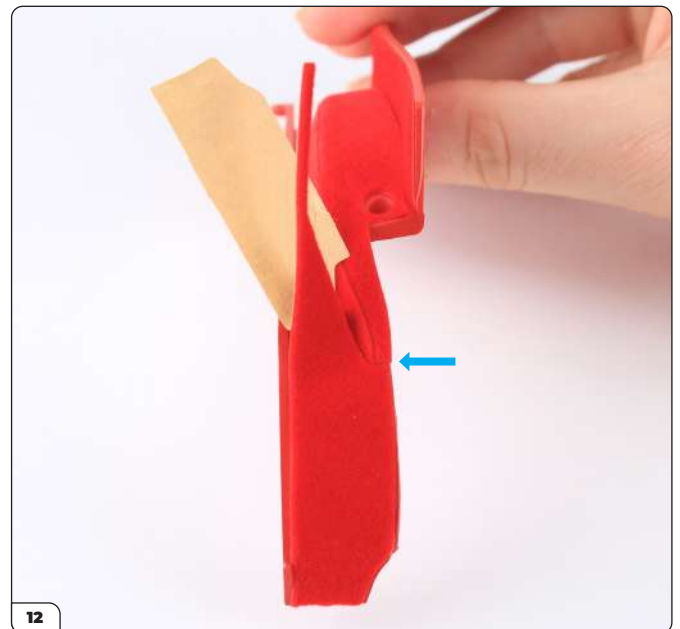

Apply the carpet, paying close attention to the joint with the thinner ends of carpets 1 and 3.

Stage 55: Applying Carpet to the Rear Left Side Panel

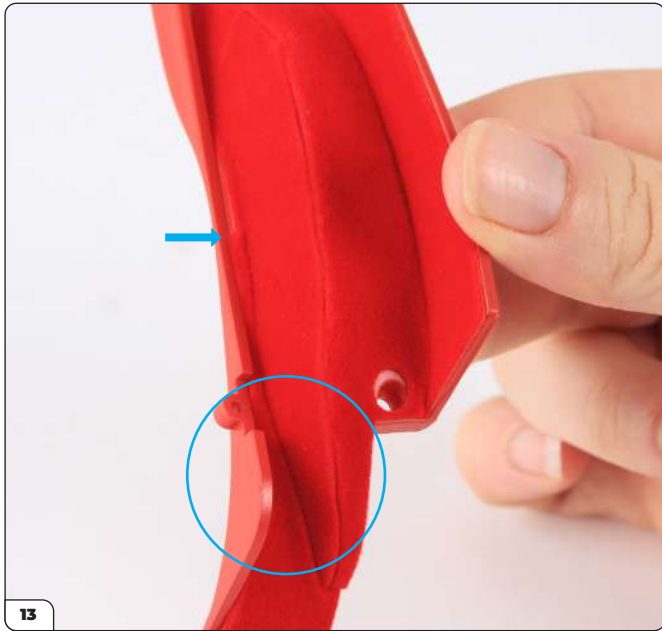

Using tweezers, press the carpet firmly down onto the panel (circled) while carefully stretching the thin end as far along as you can (arrow).

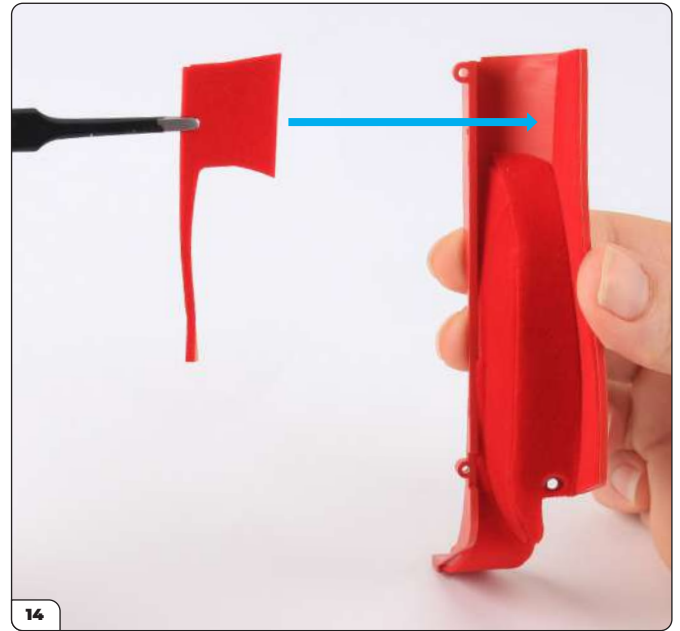

Align carpet 4 with the side panel as shown.



Starting with the larger area, apply carpet 4 and use tweezers to smooth the joins with the other pieces of carpet.



Carefully stretch and apply the thin end to join with carpet 5.

Stage 55: Applying Carpet to the Rear Left Side Panel

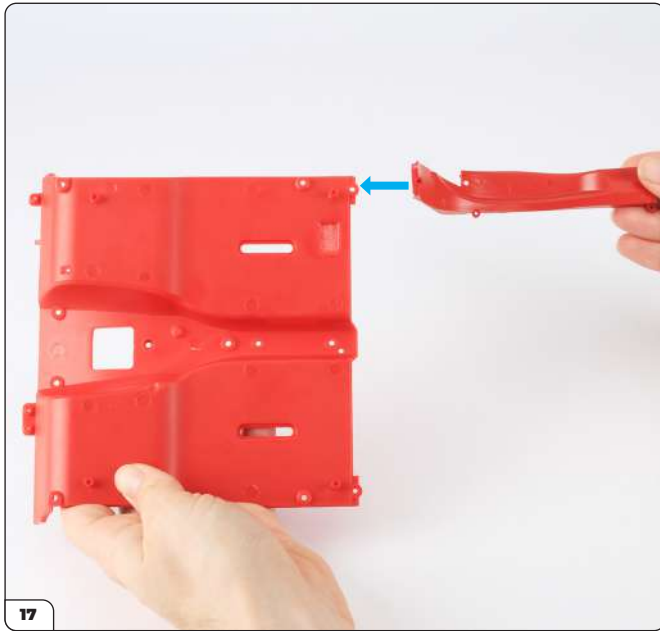

Align the rear left side panel with the interior floor. The carpeted side of both pieces should be facing away from you.

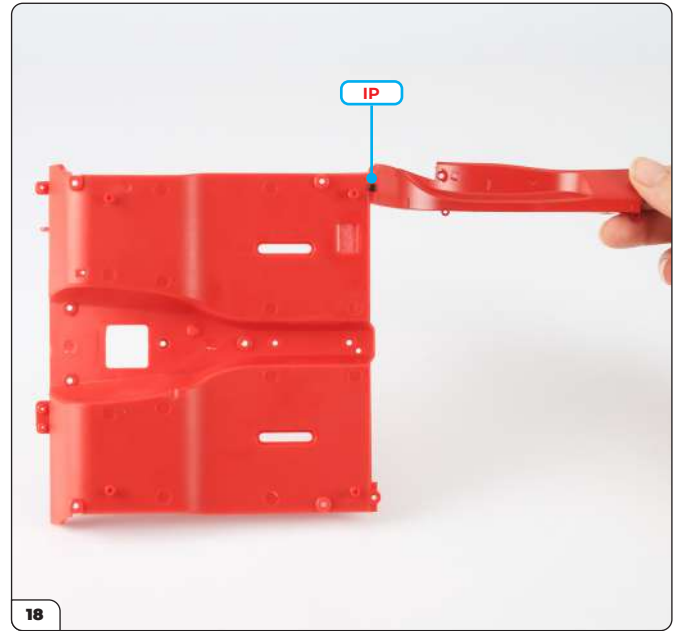

Secure the parts together using an IP screw.



Stage 56: Applying Carpet to the Rear Right Side Panel

In this stage you'll carpet and fit the rear right side panel.



STAGE 56 PARTS LIST

Name
Rear right side panel
Carpet 1
Carpet 2
Carpet 3
Carpet 4
Carpet 5
IP screw x2



Stage 56: Applying Carpet to the Rear Right Side Panel



Align carpet 2 with the rear right side panel.



Starting at one end, apply the carpet to the side panel.



Apply the other end of the carpet, taking care not to cover the opening in the side panel.



Align carpet 3 with the side panel.

Stage 56: Applying Carpet to the Rear Right Side Panel



Apply the carpet to the panel, taking care with the alignment of the thinner end.

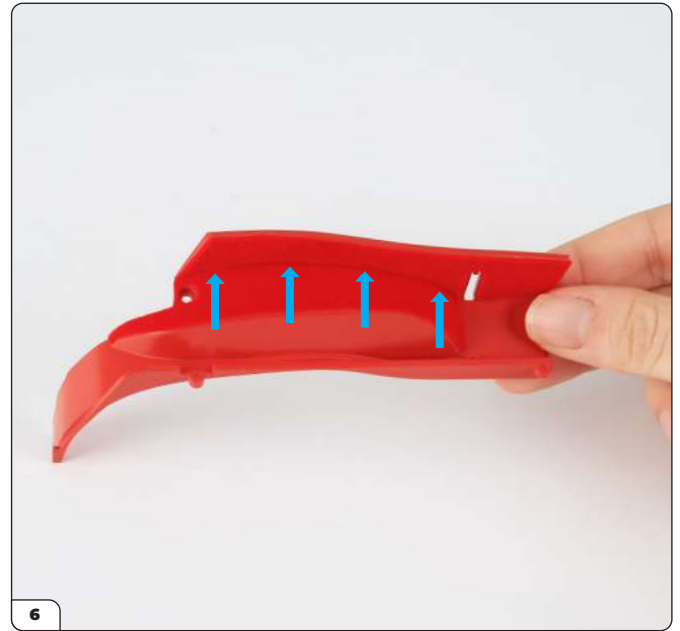

Use tweezers to smooth the edge down.



Align carpet 1 with the side panel.

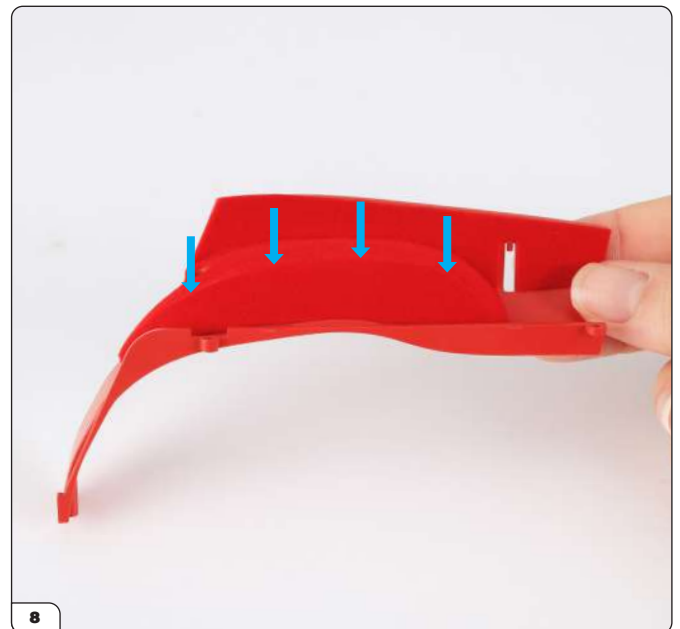

Apply the carpet to the panel, pinching the joint together.

Stage 56: Applying Carpet to the Rear Right Side Panel



Align carpet 5 with the side panel.

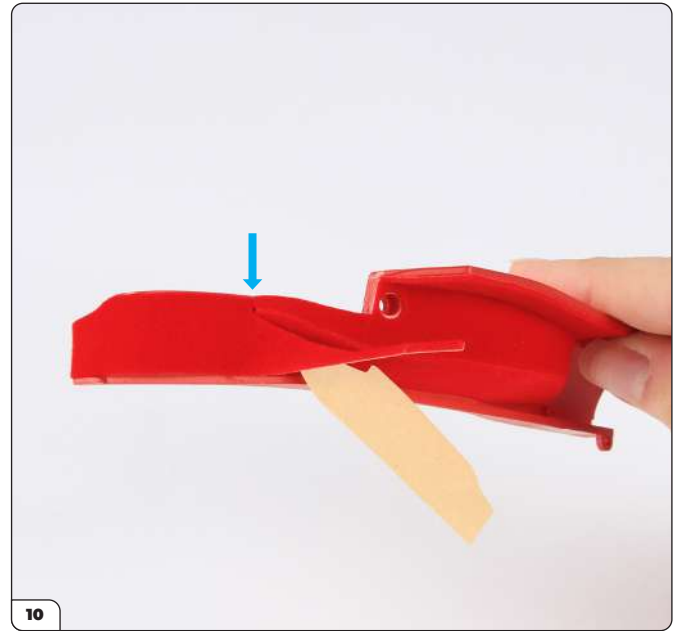

Apply the carpet, paying close attention to the join with the thin ends.



Press the thin section down firmly, carefully stretching it towards the other end.

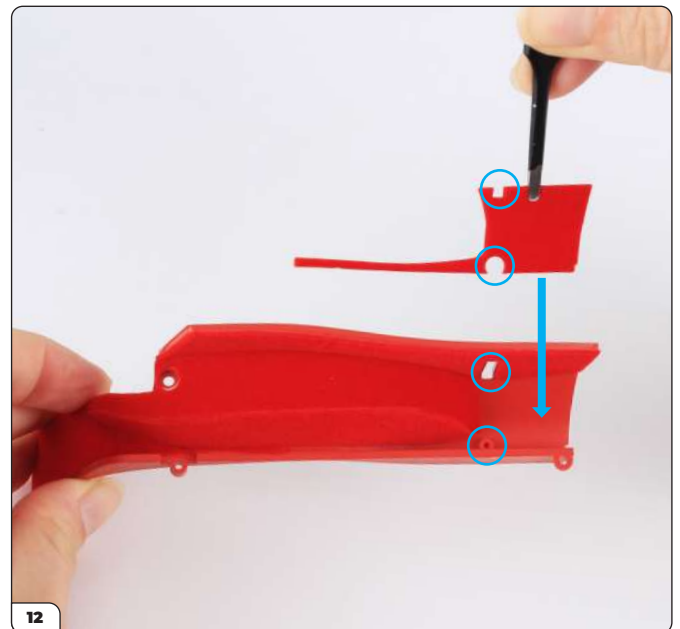

Align carpet 4, noting the gaps for the screw column and opening in the panel (circled).

Stage 56: Applying Carpet to the Rear Right Side Panel

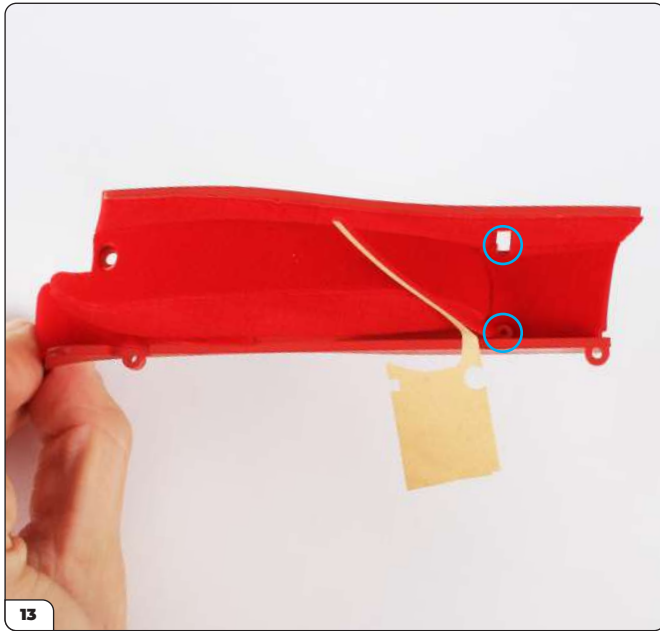

Apply the carpet, taking care with the alignment of the gaps.

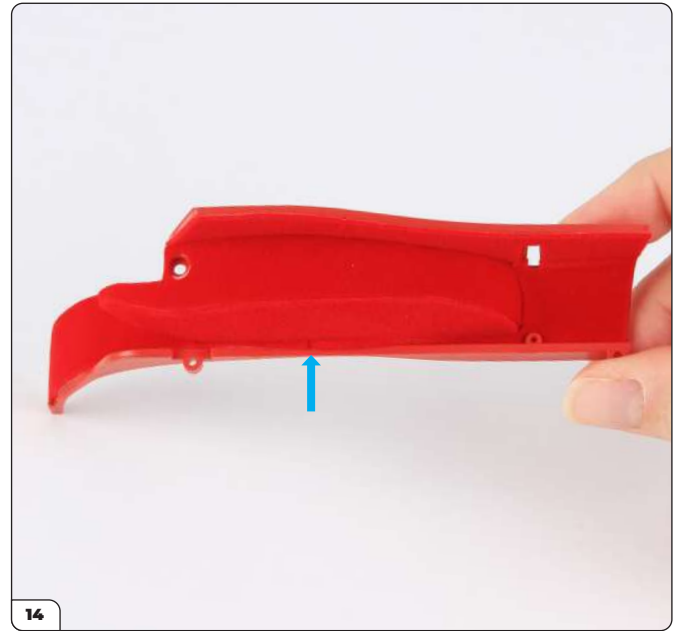

Carefully stretch and apply the thin end to join it with the other.

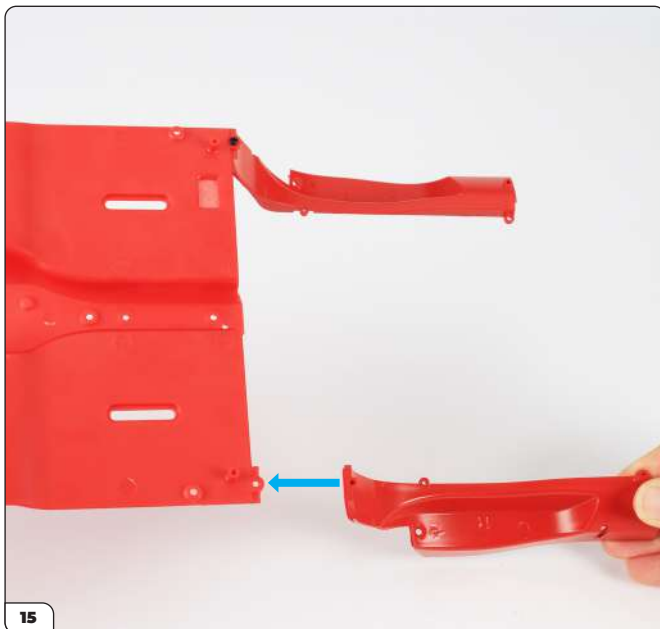

Align the rear right side panel with the interior floor.

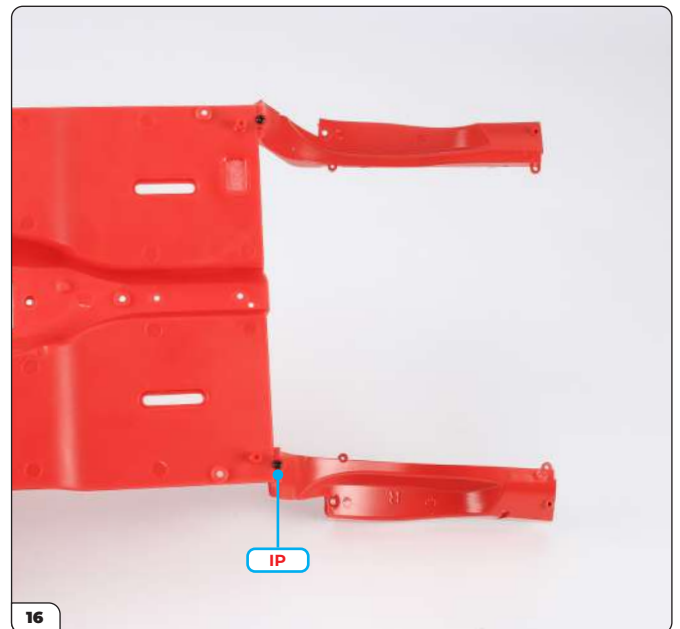

Fit and secure with an IP screw.

Stage 56: Applying Carpet to the Rear Right Side Panel

STAGE COMPLETE



Stage 57: Fitting the Rear Panel and Cross Member

You'll continue to assemble the interior floor by fitting the rear panel and cross member.



STAGE 57 PARTS LIST

Name
Rear panel
Rear cross member
Rear panel carpet
JP screw x3
MP screw x3



Stage 57: Fitting the Rear Panel and Cross Member

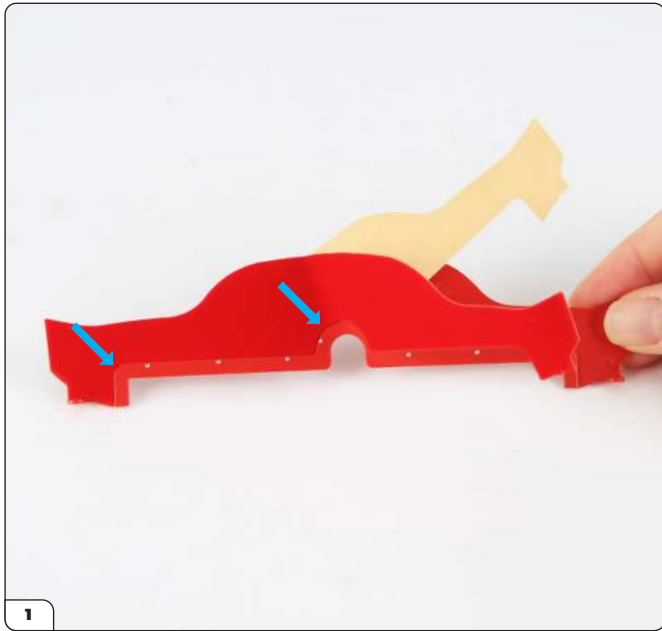

1
Half-peel the backing and apply the carpet to the rear panel, taking care to align the rounded corners.

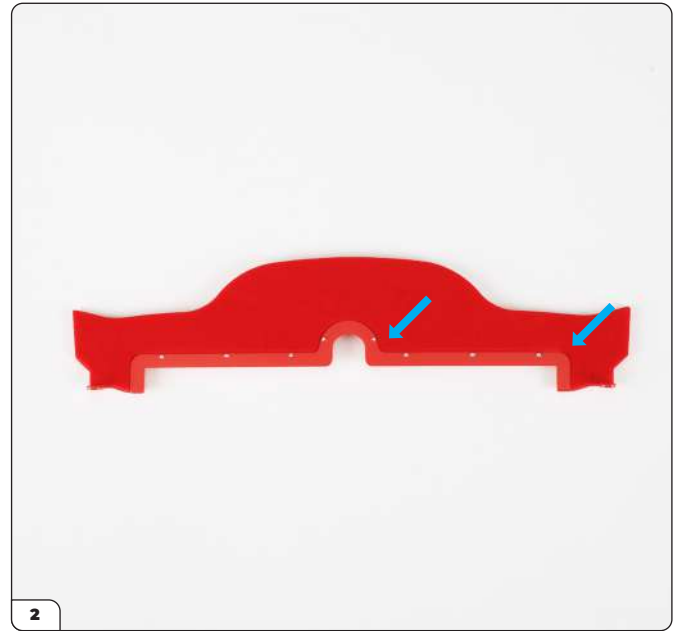

2
Finish applying the rear panel's carpet following the edges carefully.

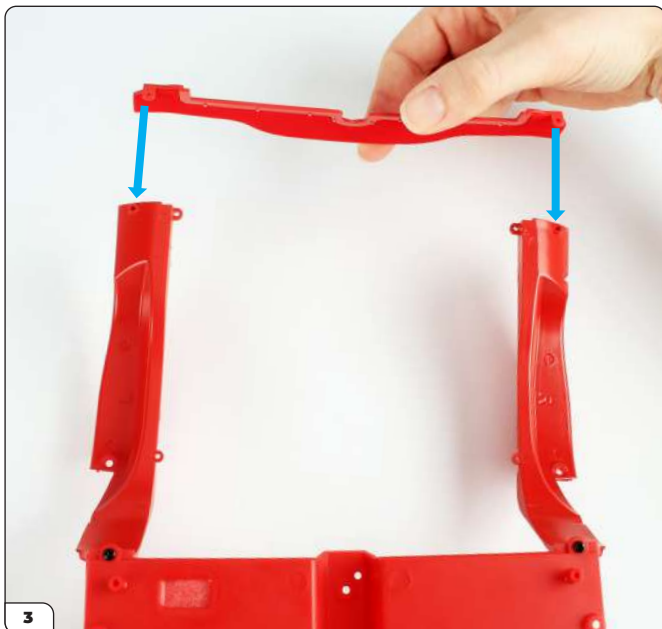

3
Place the interior floor upside down on the work surface then fit the rear panel onto the screw columns.

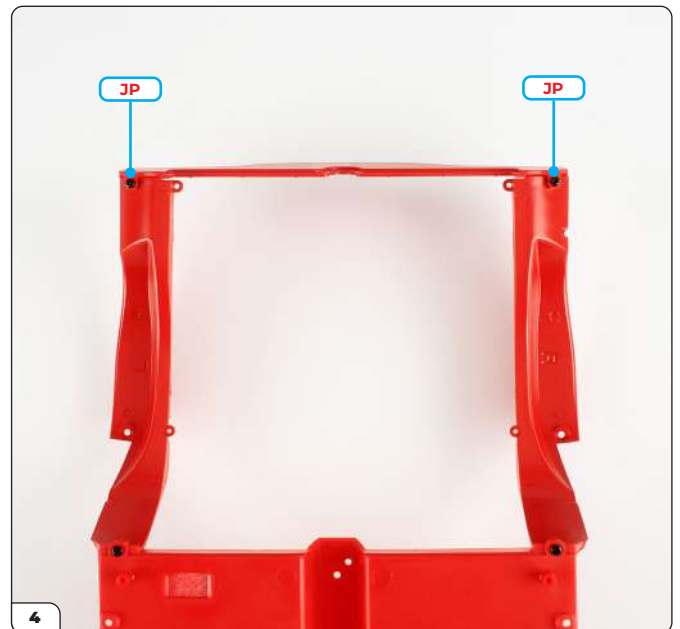

4
Secure using 2x JP screws.

Stage 57: Fitting the Rear Panel and Cross Member

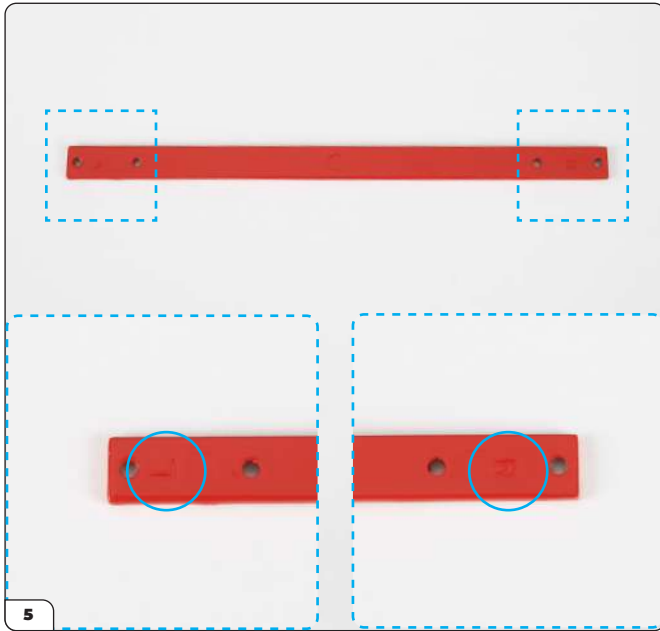

The cross member is marked with 'L' and 'R' to help mount it in the correct orientation on the interior floor.

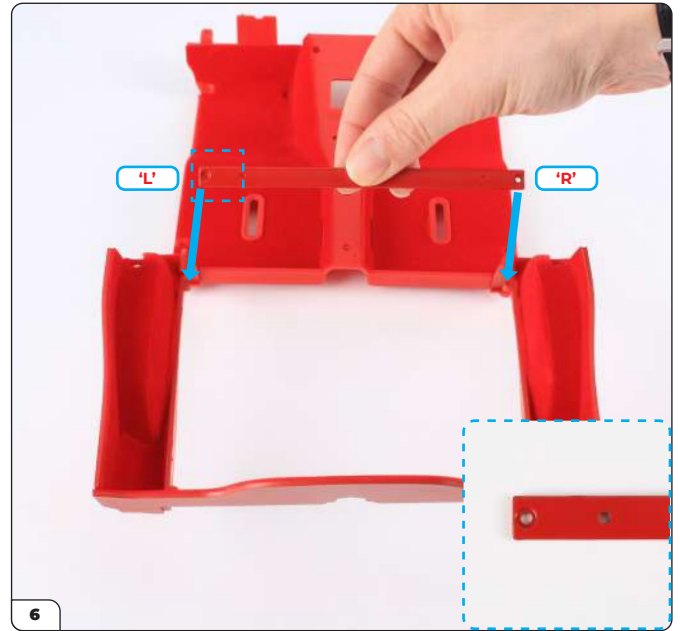

Place the interior floor upright on the work surface and align the cross member with it as shown. The 'L' and 'R' should be on the left and right side respectively. The cross member's recessed screw holes need to face up (inset).



Secure the cross member with 2x MP screws.

Stage 57: Fitting the Rear Panel and Cross Member

STAGE COMPLETE



Stage 58: Fitting the Left Side Panel

In this stage you'll fit the carpet to the left side panel then mount it onto the interior floor assembly.



STAGE 58 PARTS LIST

Name
Left side panel
Carpet 1
Carpet 2
Carpet 3
NP screws x4



Stage 58: Fitting the Left Side Panel

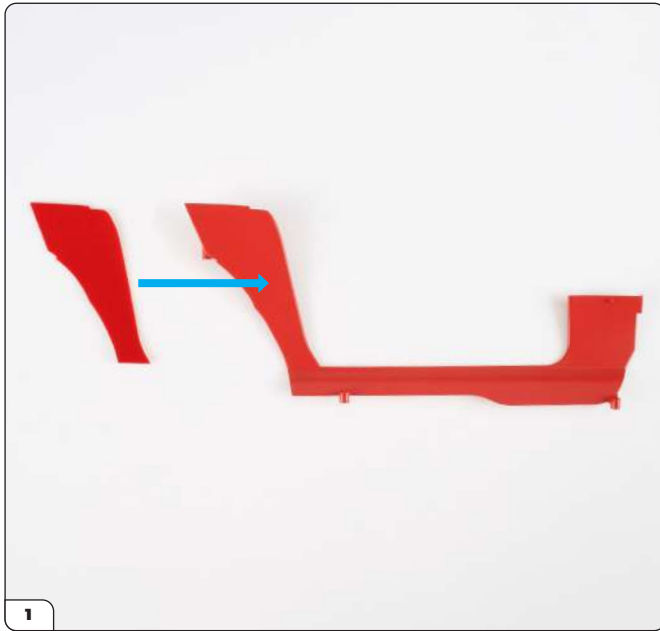

Align carpet 2 with the left side panel.

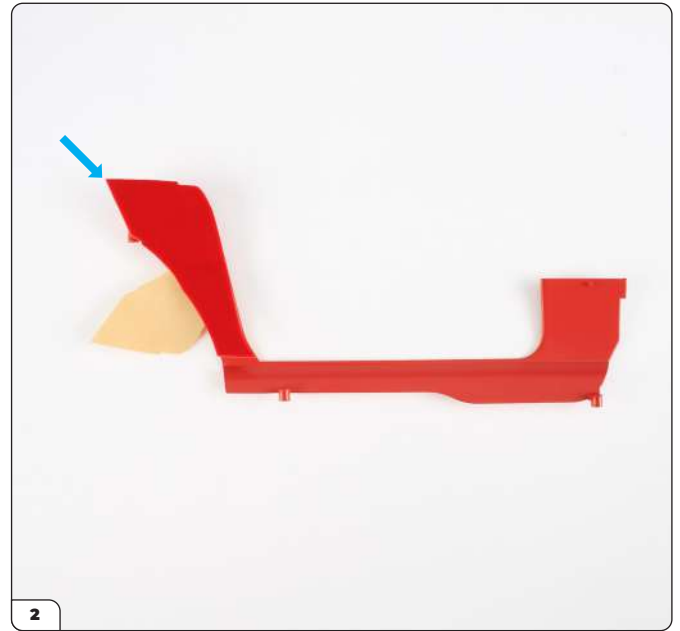

Half-peel the backing paper and start to apply the carpet as shown.



Finish applying the carpet, making sure the end aligns with the edge of the panel as shown by the dashed line.



Align carpet 1 with the panel.

Stage 58: Fitting the Left Side Panel



Start to apply the carpet, taking care to align the end with the edge of carpet 2.



Finish applying the carpet following the edges carefully.

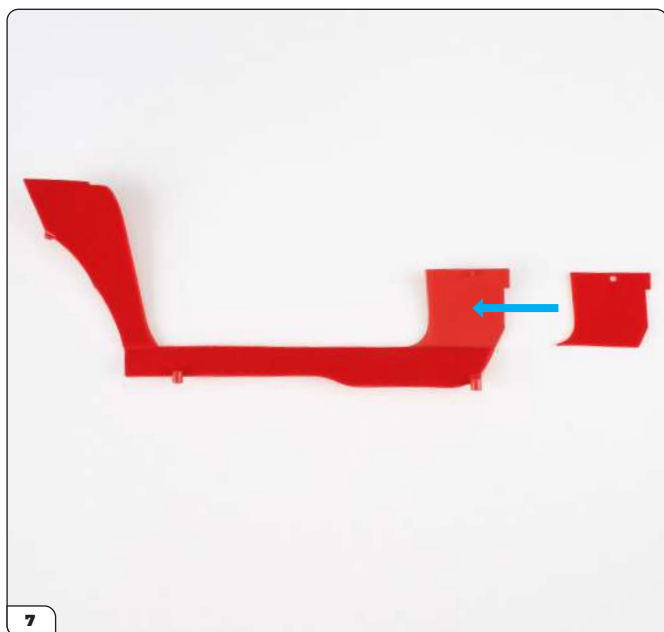

Align carpet 3 with the panel.



Start applying the carpet by fitting the hole over the pin.

Stage 58: Fitting the Left Side Panel



Carefully stretch the carpet to the edge if needed and press firmly to join together.



Align the left side panel with the interior floor assembly.



Fit the panel in place then check the edges of the carpet are joined smoothly.

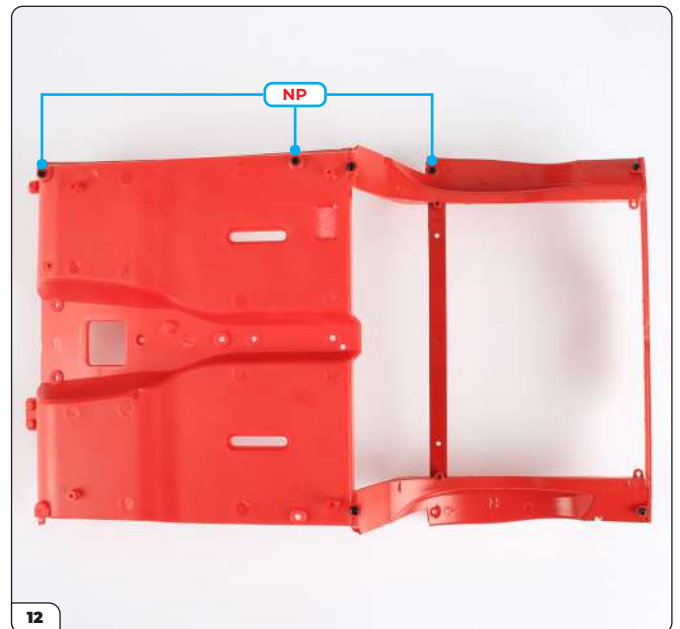

Turn the assembly over and secure the panel with 3x NP screws.

Stage 58: Fitting the Left Side Panel

STAGE COMPLETE



Stage 59: Fitting the Right Side Panel

For the last stage of this pack you'll fit the right side panel and carpet to the interior floor assembly.



STAGE 59 PARTS LIST

Name
Right side panel
Carpet 1
Carpet 2
Carpet 3
NP screw x4



Stage 59: Fitting the Right Side Panel

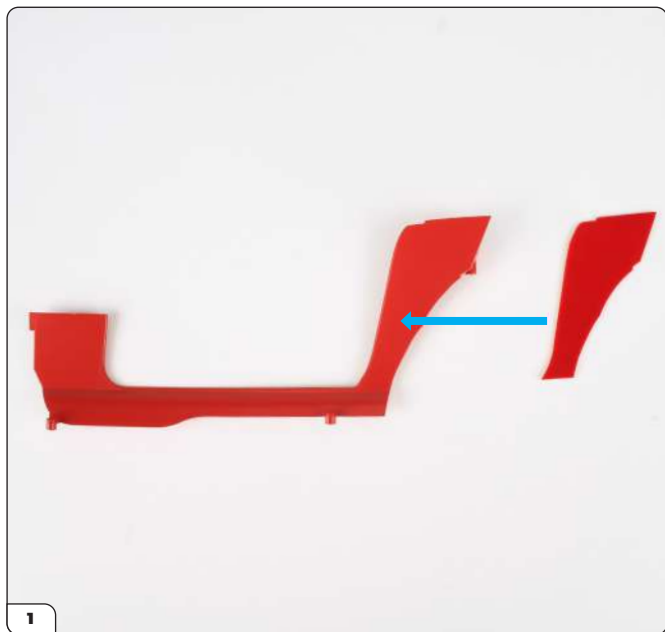

Align carpet 3 with the right side panel.



Half-peel the backing paper and start to apply the carpet as shown.



Finish applying the carpet, aligning the end with the edge of the panel as shown by the dashed line.



Align carpet 1 with the panel.

Stage 59: Fitting the Right Side Panel



Apply the carpet, aligning the end with the edge of carpet 2.



Align carpet 2 with the panel.



Apply the carpet while aligning the edges.

Stage 59: Fitting the Right Side Panel



Align the right side panel with the interior floor assembly as shown.



Fit the panel in place then check the edges of the carpet are joined smoothly.

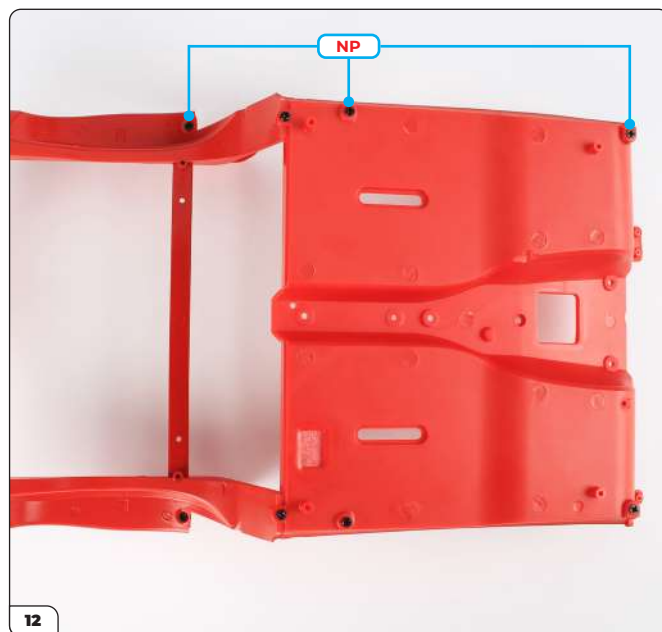

Turn the assembly over and secure the panel with 3x NP screws.

Stage 59: Fitting the Right Side Panel

STAGE COMPLETE

