

TITANIC

THE SHIP • THE LEGEND

Pack 11



THE FOURTH FUNNEL

PARTS IN THIS ISSUE

- 57A** Funnel plating
- 57B** Funnel interior
- 57C** Top of fourth funnel
- 57D** Stay collar
- 57E** Forward water pipe
- 57F** Platform
- 57G** Aft water pipe
- 57H** Whistle with steam supply pipe
- 57I** Interior of fourth funnel
- 57J** Ladder
- 57K** Funnel cap
- AP** Three 2.3 x 5mm PB screws (1 spare)
- DP** Seven 1 x 2mm PB screws (1 spare)

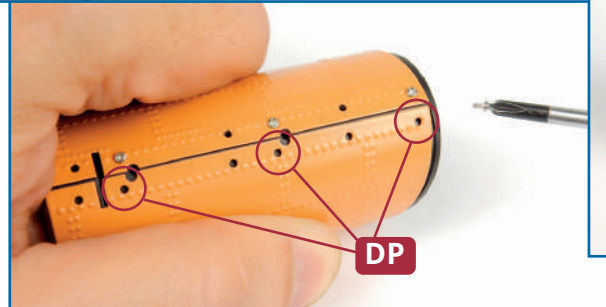
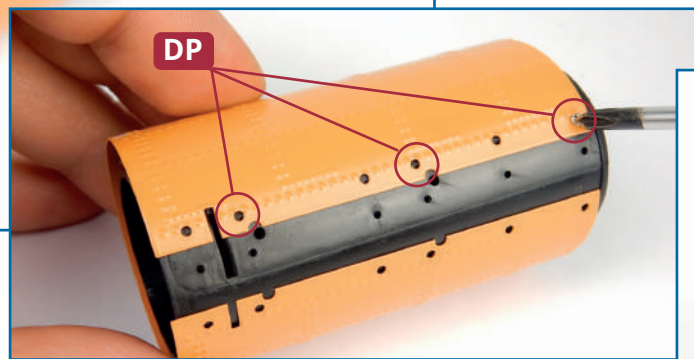
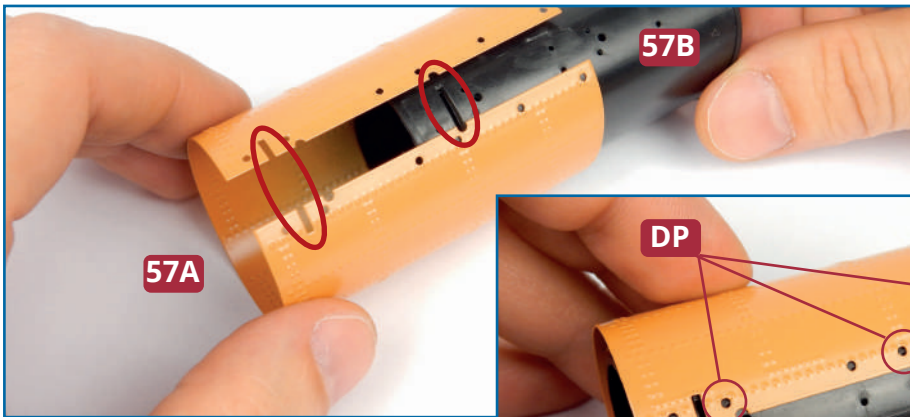

1 Take the funnel interior **57B** and fit it inside the plating **57A**. Check that the notches in the plating align with the slot in the funnel (circled in red, above). Fix one side of the plating in place with three **DP** screws (above right), then use three more **DP** screws to fix the other side in place using the screw holes indicated (right).

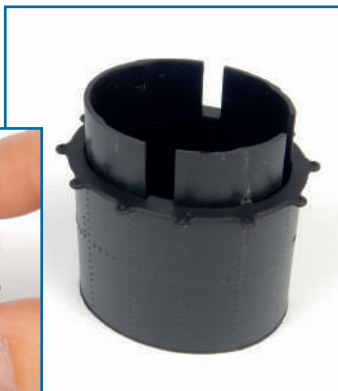
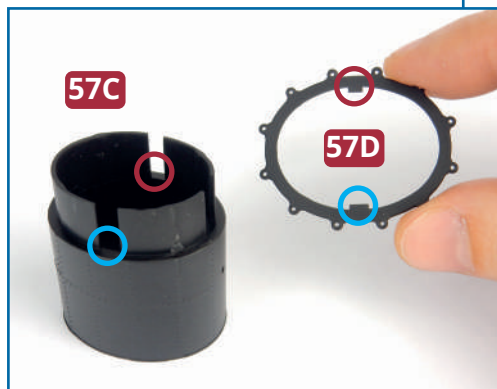

2 Take the stay collar **57D** and fit it on the top of the funnel **57C**, so that the tabs in the collar slide into the slots in the funnel. Note that the tabs are different sizes. The more detailed side of the stay collar faces upwards. Now fit the top of the funnel **57C** into the funnel assembly, pushing it firmly in place. The three holes in part **57C** (circled in yellow) align with the 'seam' in the plating **57A**.

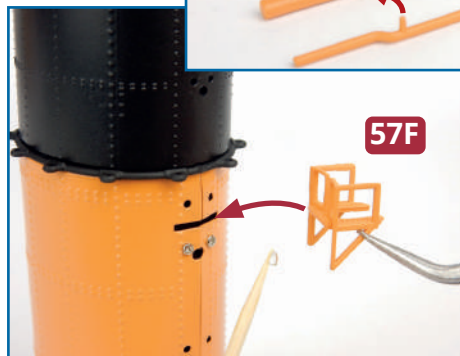
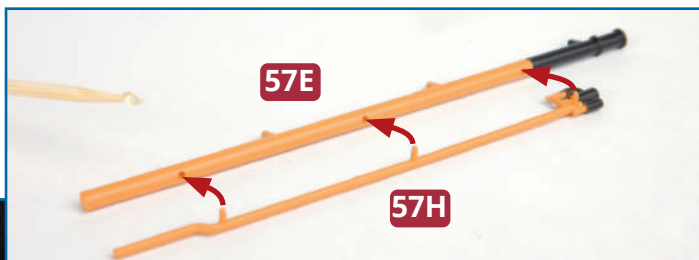

3 Take the platform **57F** and fit the tab into the slot in the funnel plating. Apply a little glue to the tab and fix in place. The three pegs on the pipe with the whistle **57H** fit into holes in the forward water pipe **57E** (top). Glue in place (above right). The pegs on the forward water pipe **57E** fit into holes on the seam in the plating **57A**. Glue in place (right).

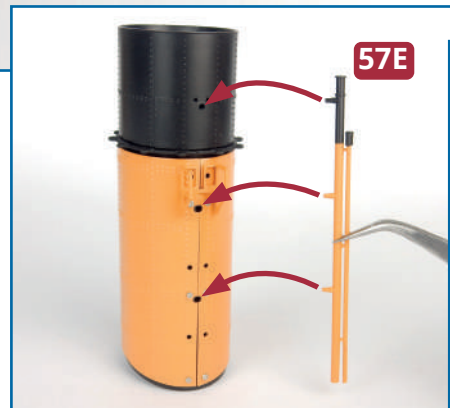

★ STEP-BY-STEP INSTRUCTIONS ★

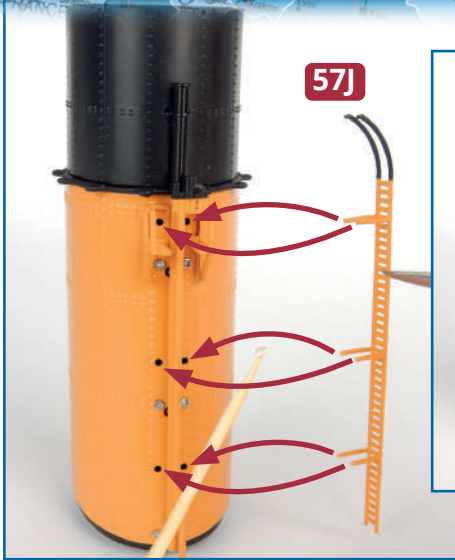

57J



4 Six pegs on the ladder **57J** fit into holes in the plating on either side of the water pipe. Glue in place. Three pegs on the aft water pipe **57G** fit into holes on the other side of the funnel assembly (below). Glue in place.

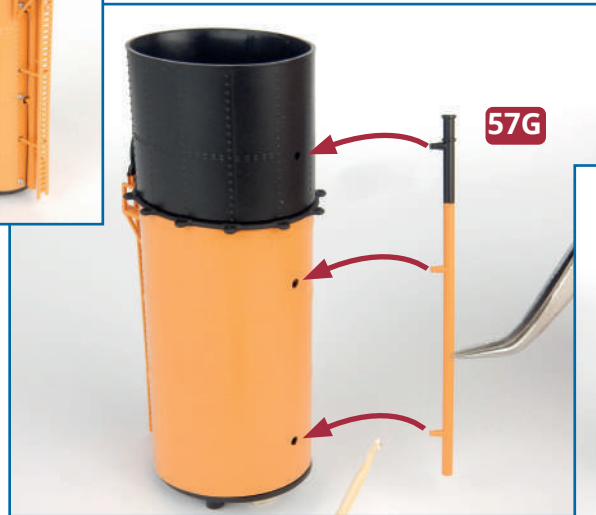

57G



57I

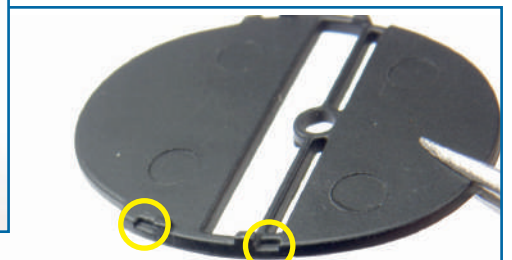

57K

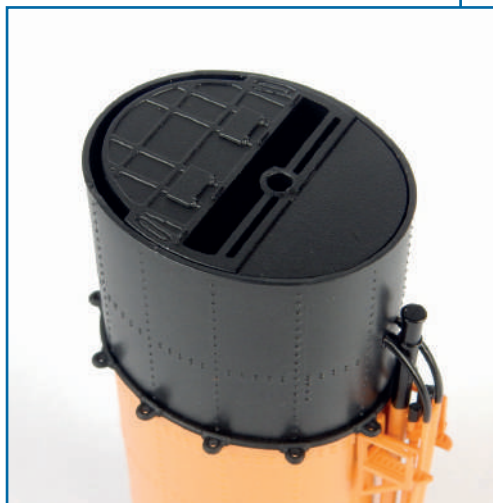

5 Fit the interior of the funnel **57I** inside the funnel assembly. Then fit the funnel cap **57K** in place so that the notches in the cap fit over the blocks on the inside of the top of the funnel (circled in yellow, above). Hold in place temporarily with a little masking tape.



6 Take the base of the fourth funnel, assembled in issue 56. Fit the fourth funnel on the base **56B**, then, holding the funnel in position, turn the base over so that you can fix the funnel in place with two **AP** screws.

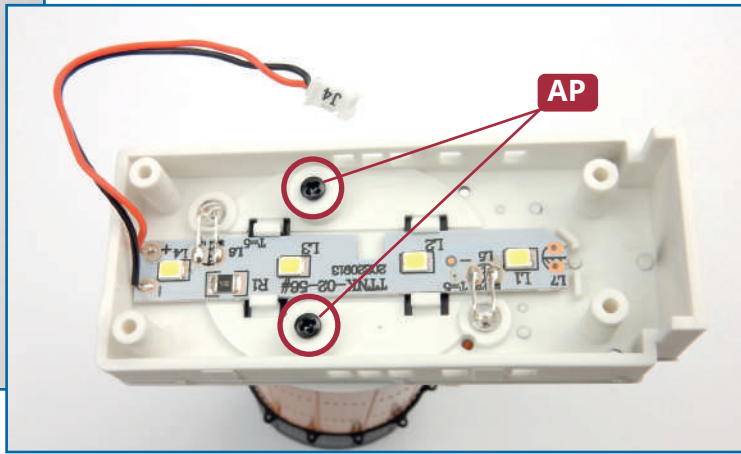
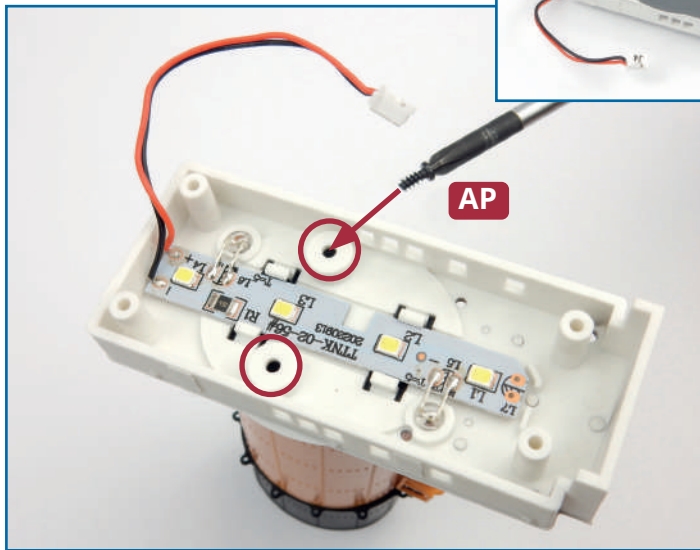
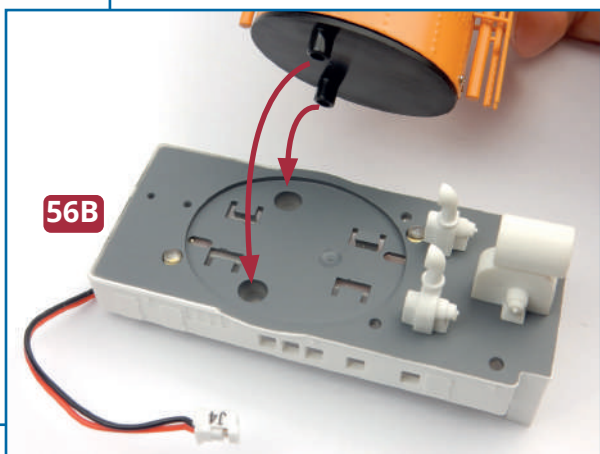

Completed work

The fourth funnel has been assembled and fixed to the base.

THE FIRST-CLASS SMOKING ROOM

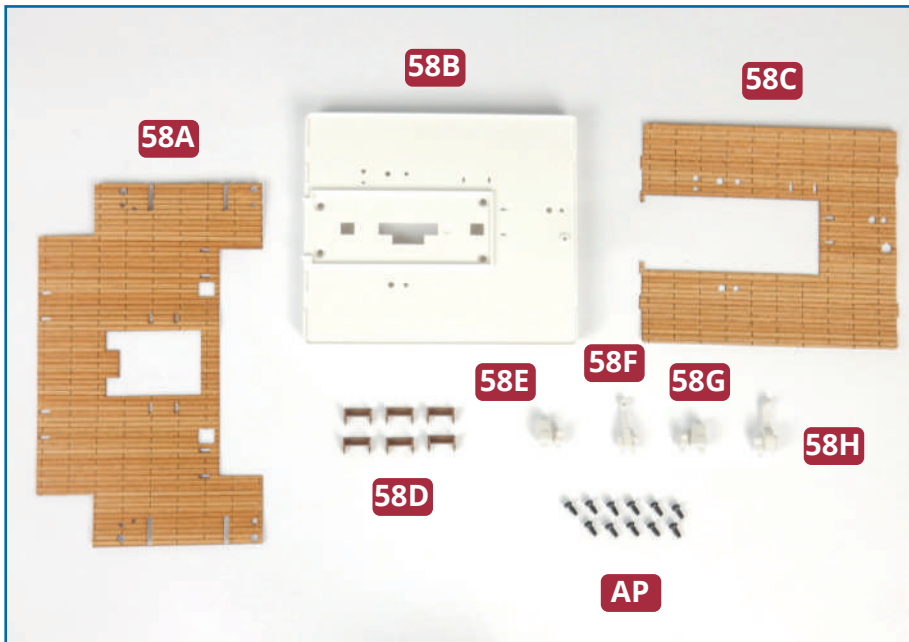

PARTS IN THIS ISSUE

- 58A** Decking for boat deck (aft)
- 58B** First-class smoking room
- 58C** Decking for roof of smoking room
- 58D** Benches (x 6)
- 58E** Vent
- 58F** Cowl
- 58G** Vent
- 58H** Cowl
- AP** Eleven 2.3 x 5mm PB screws (1 spare)

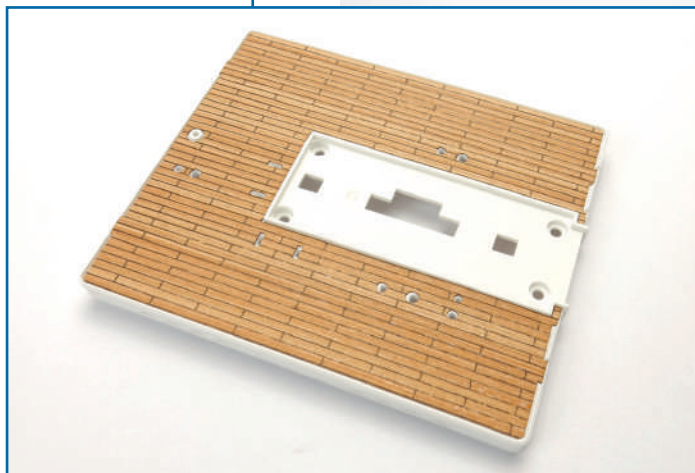
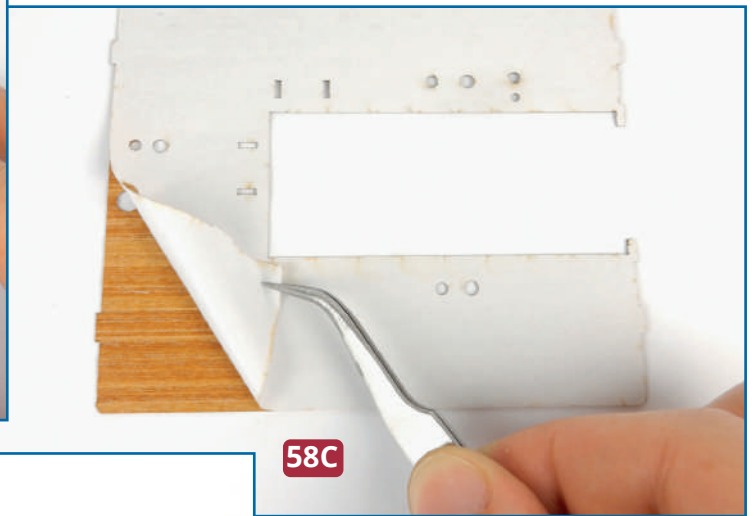
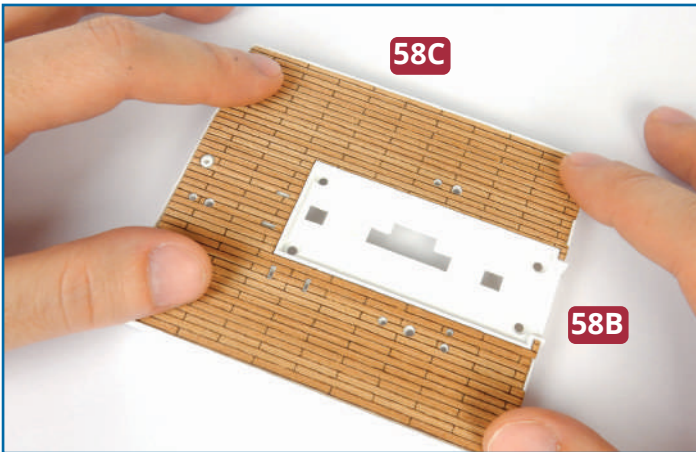

1 Take the first-class smoking room **58B** and decking panel **58C**. Check how the decking fits so that all the holes are aligned, then remove the backing and fix it in place on the roof of the smoking room **58B**. If necessary trim a little decking from each side of part **58C** for a better fit. Smooth it out and press it down with a soft cloth.

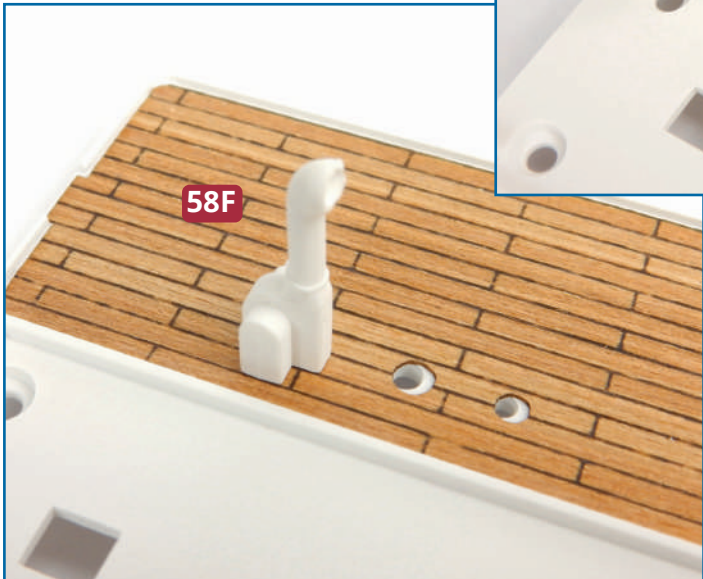
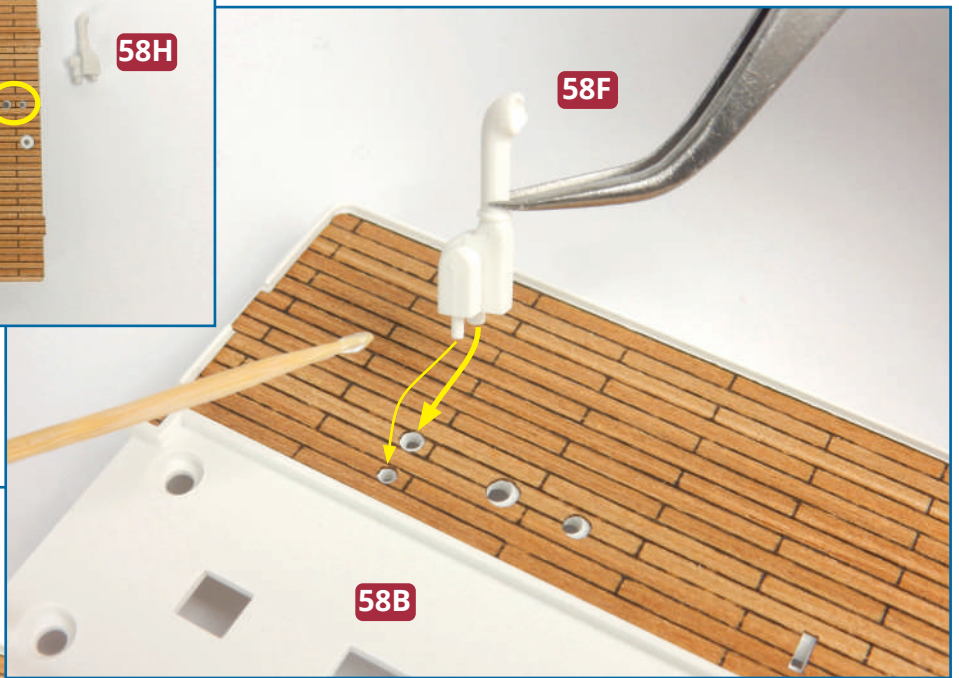
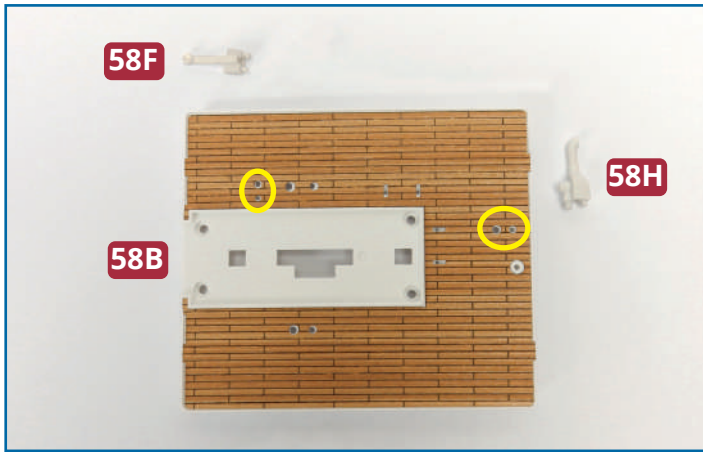

2 Take the two cowls **58F** and **58H** and glue them to the roof of the first-class smoking room **58B**, as shown. Note that the pegs are different sizes and orientations to help position them correctly.



★ STEP-BY-STEP INSTRUCTIONS ★

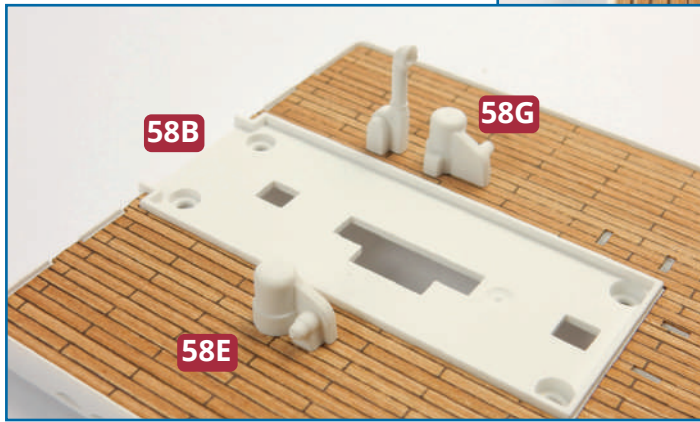
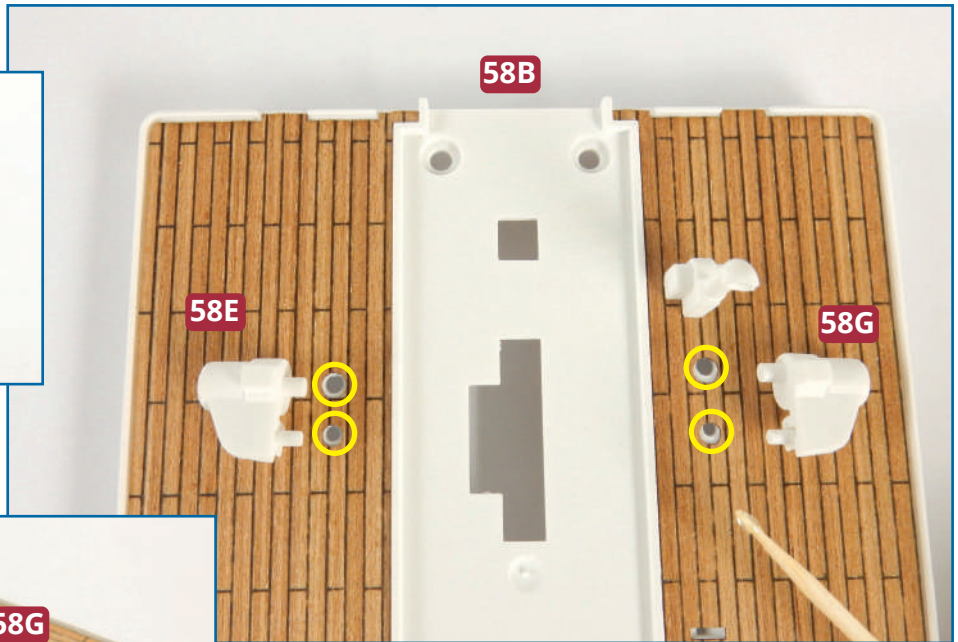
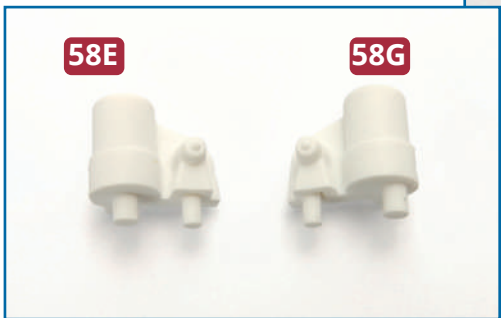

3 Now take the two vents **58E** and **58G**. Glue them in place on the roof of the first-class smoking room **58B**, as shown. Again, the pegs are different sizes to help you position them correctly.

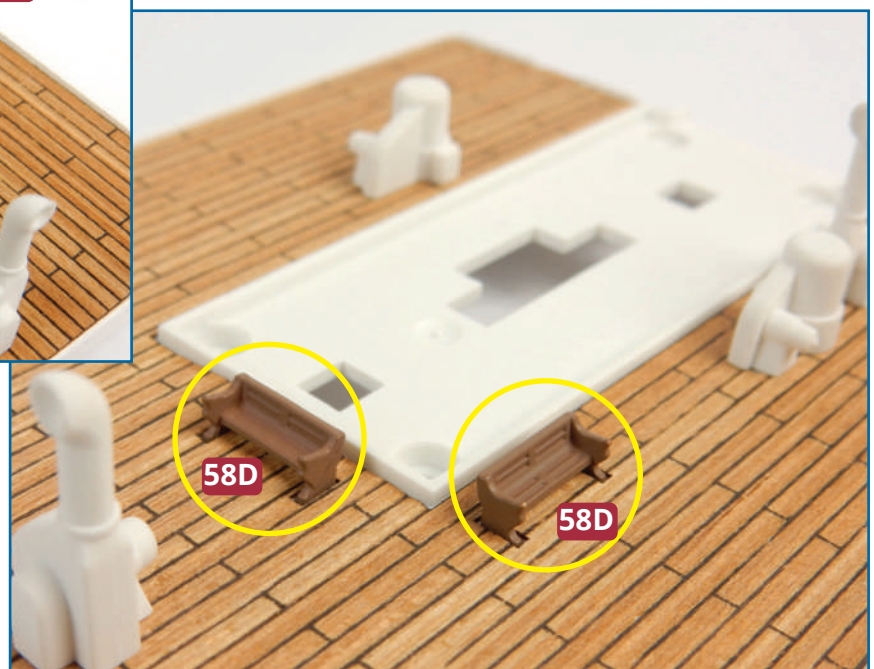
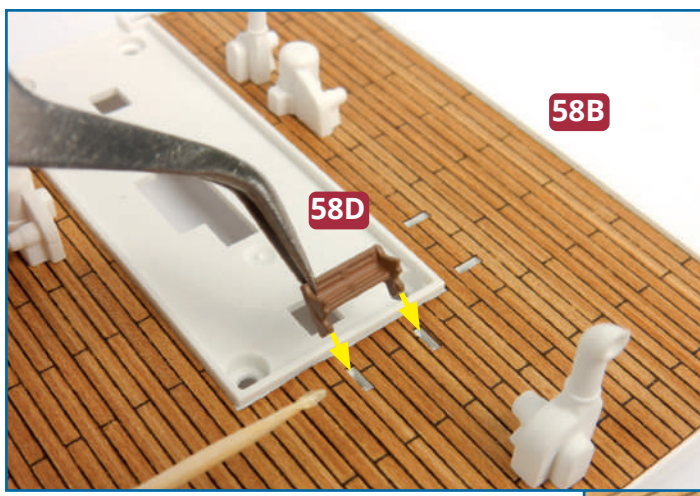

4 Take two of the benches **58D**. Tabs on the bottom of the benches fit into slots around the central panel of the roof of the smoking room **58B**. Glue them in place.

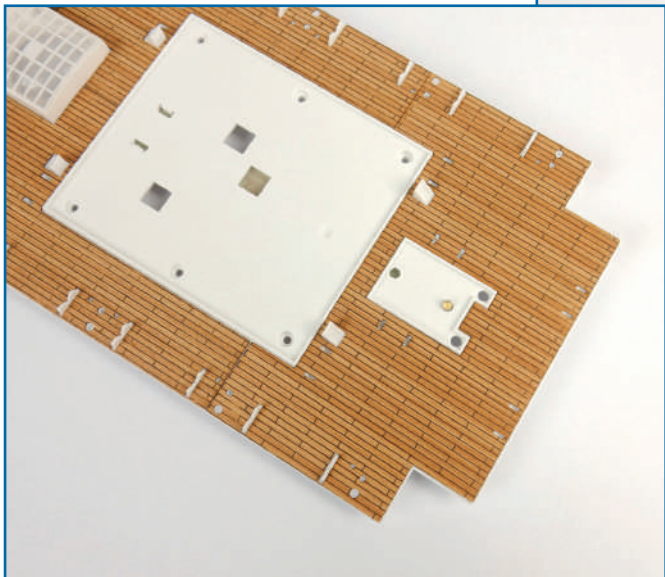
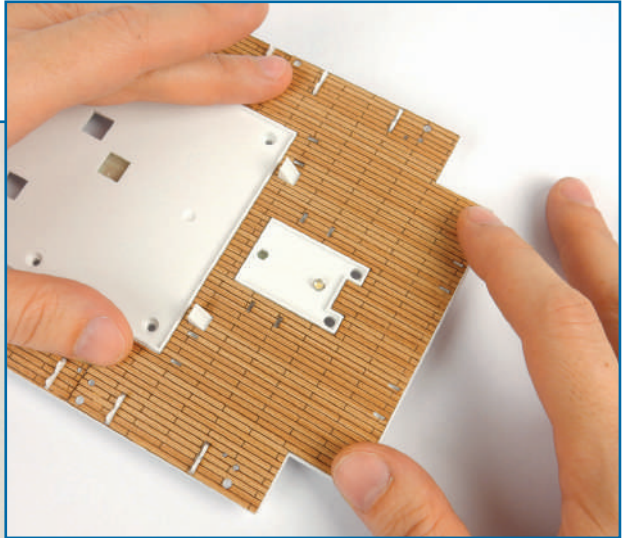
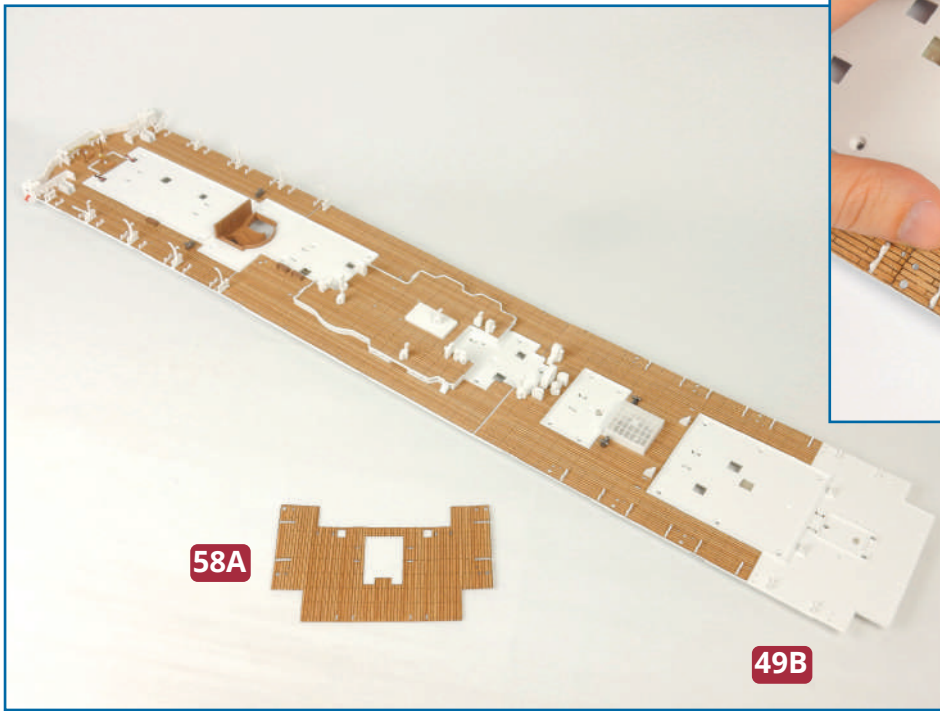

5 Take the boat deck from issue 53 and decking **58A**. Check how the decking fits at the aft end of the deck **49B** so that all the holes are aligned. Remove the backing from the decking and fix it in place, smoothing it out with a soft cloth.

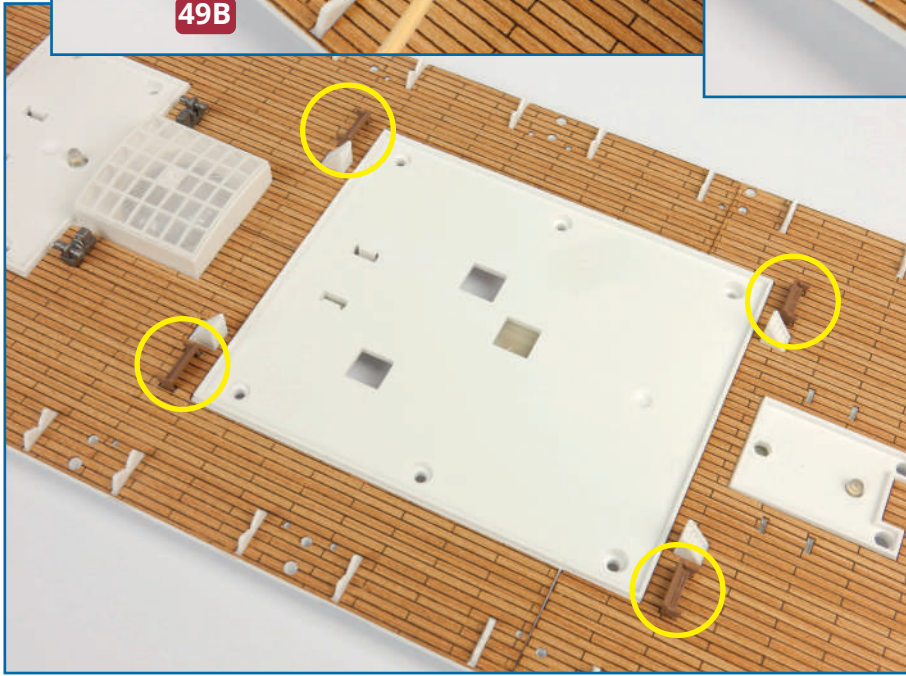
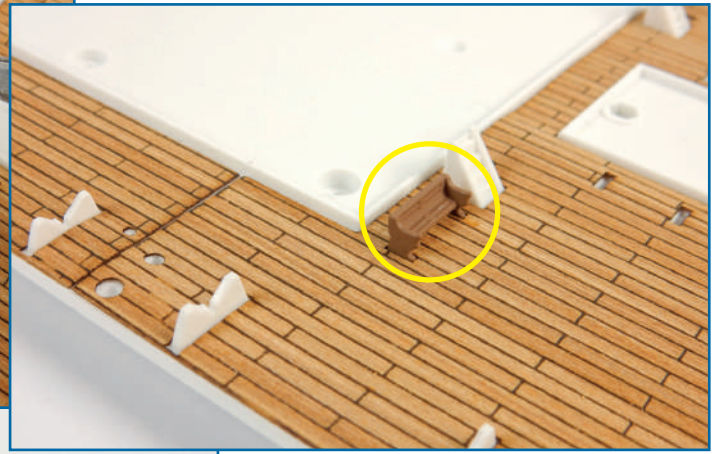

6 Take the four remaining benches **58D** and glue them in place beside the stairs at the corners of the panel at the aft end of the deck **49B**. Glue the tabs on the benches into the slots in the deck.

Completed work

The first-class smoking room has been assembled and decking, vents and benches have been fitted in place. Store the unused **AP** screws carefully as they will be needed in a future issue.

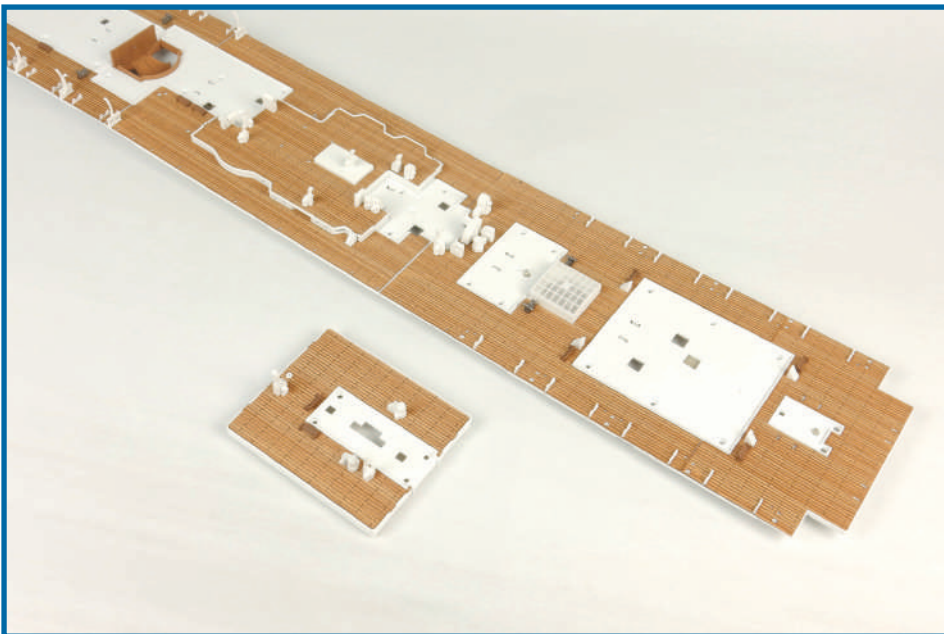

LIFEBOATS AND DAVITS FOR THE PORT SIDE



PARTS IN THIS ISSUE

- 59A** Davit base C (x 3)
- 59B** Lifeboats
- 59C** Davit base D (x 2)
- 59D** Lifeboat block gear (x 8)
- 59E** Davit arms C2 (x 3)
- 59F** Lifeboat tarpaulins (x 4)
- 59G** Davit arms C1 (x 5)
- 59H** Vent
- 59I** Cowl
- 59J** Tall Cowl

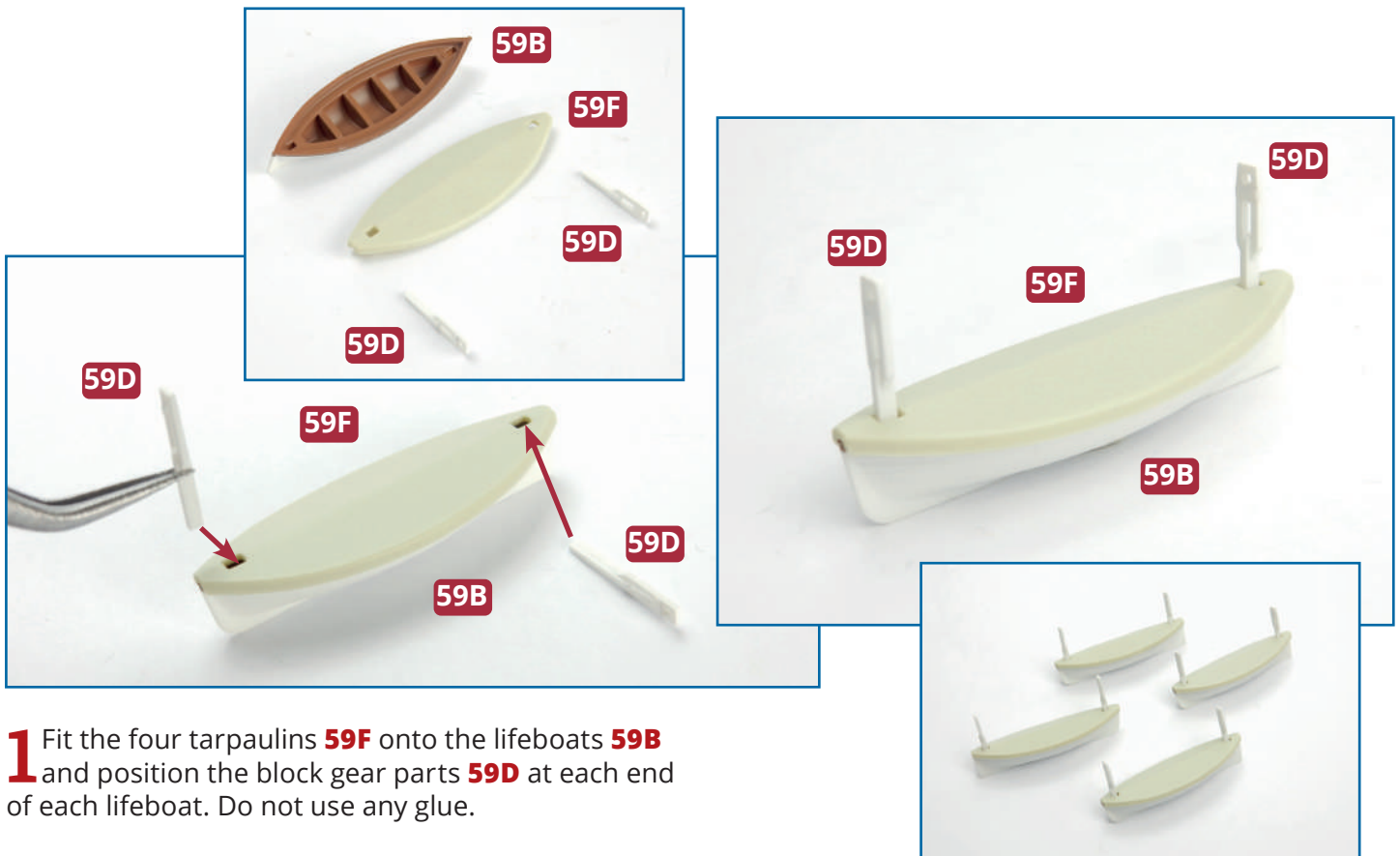

1 Fit the four tarpaulins **59F** onto the lifeboats **59B** and position the block gear parts **59D** at each end of each lifeboat. Do not use any glue.

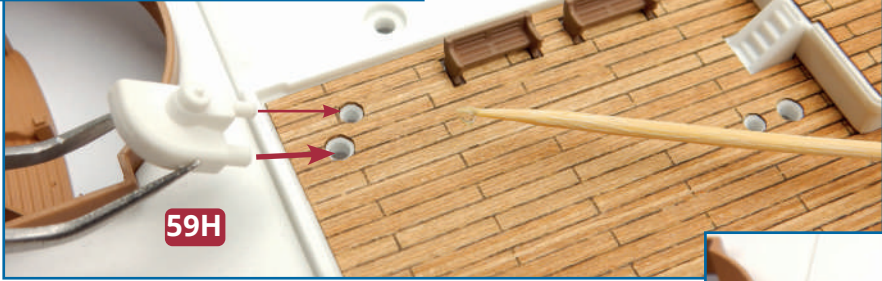

2 Take the vent **59H** and tall cowl **59J**. Identify the fixing points on the boat deck from the previous issue: they are positioned near the forward staircase, on the port side. Glue in place.

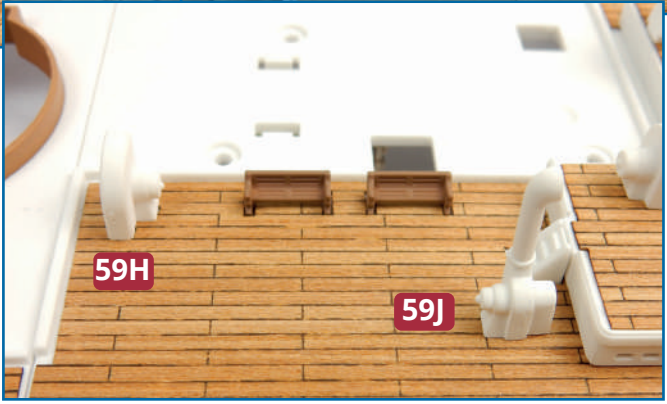

3 The cowl **59I** is fitted on the starboard side, near the staircase. Glue in place.

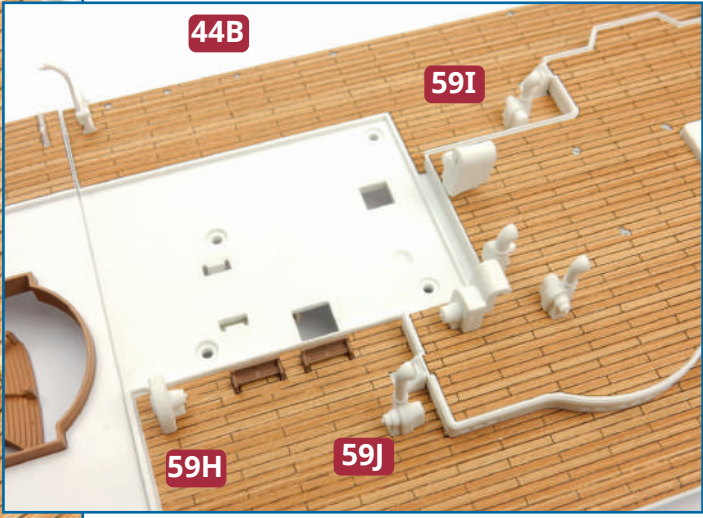
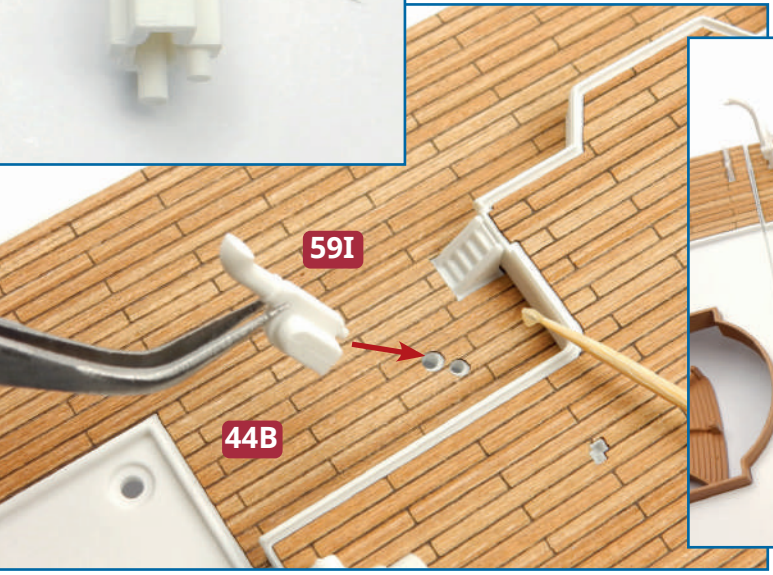

★ STEP-BY-STEP INSTRUCTIONS ★

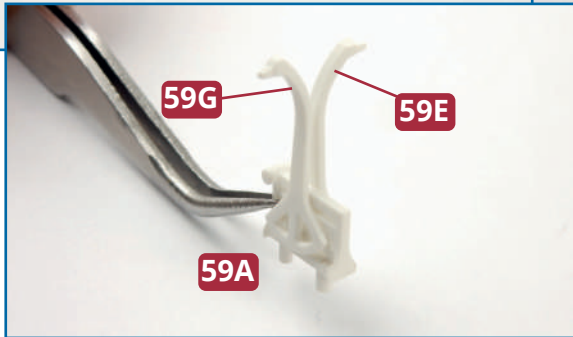
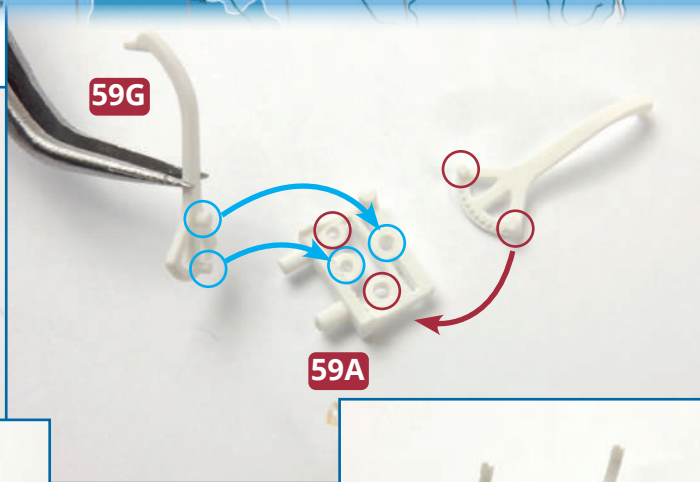
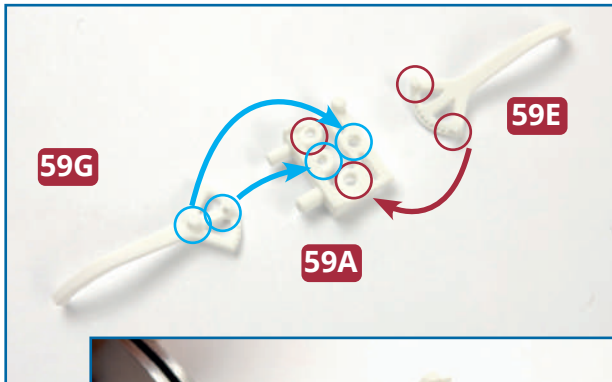

4 Take the three davit bases C **59A**, three C1 arms **59G** and three C2 arms **59E**. Glue the arms to the bases, to create three double sided davits.

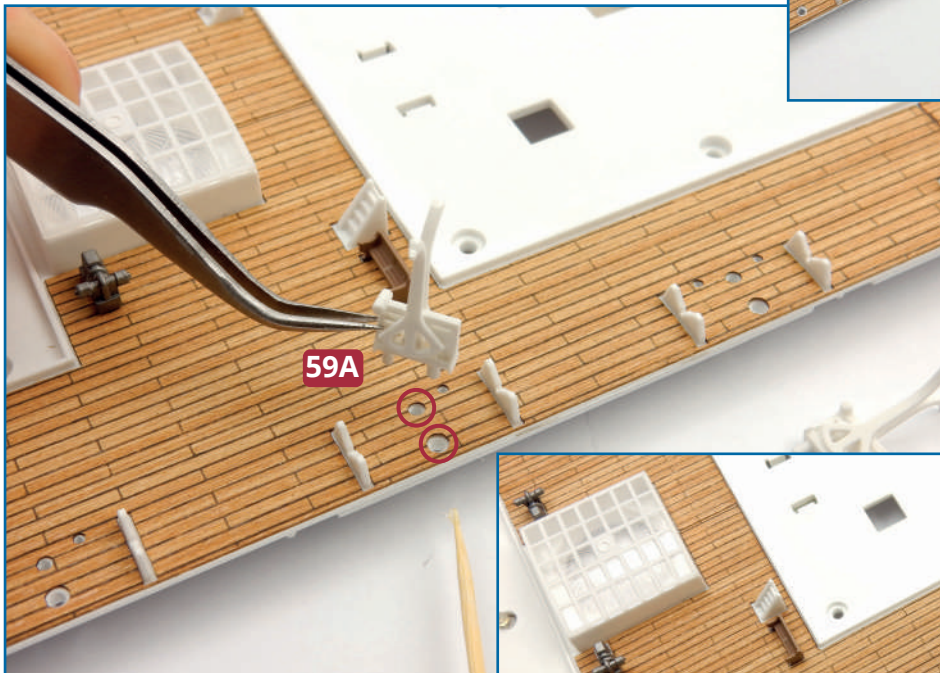
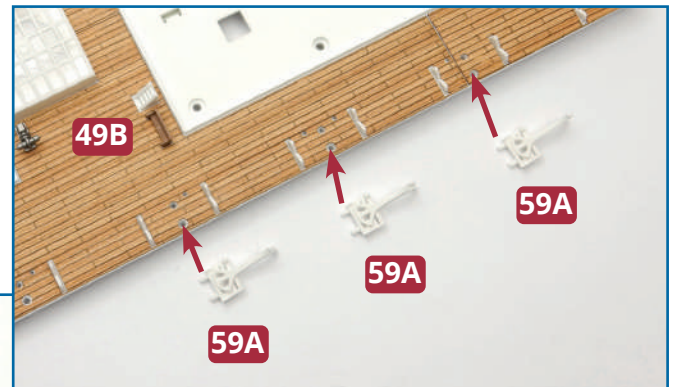

5 The three double davits are fitted on the port side of the boat deck, at the aft, between the pairs of lifeboat cradles. Glue in place, taking care to fit them the right way round: on each davit base, the outer peg/hole is larger than the inner one (left).

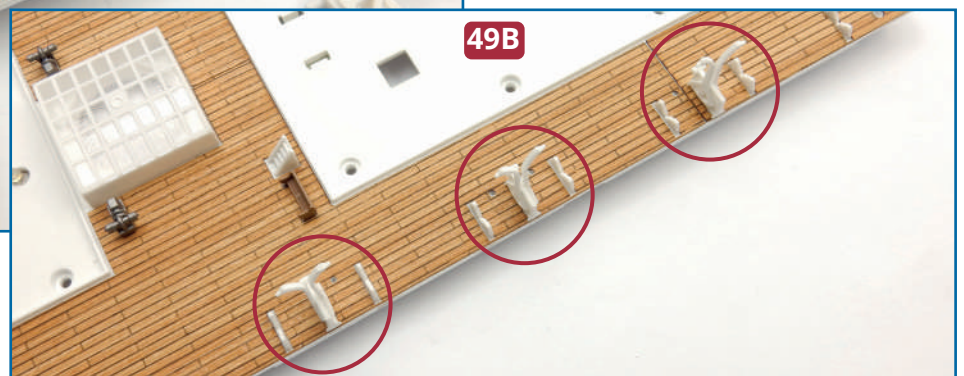

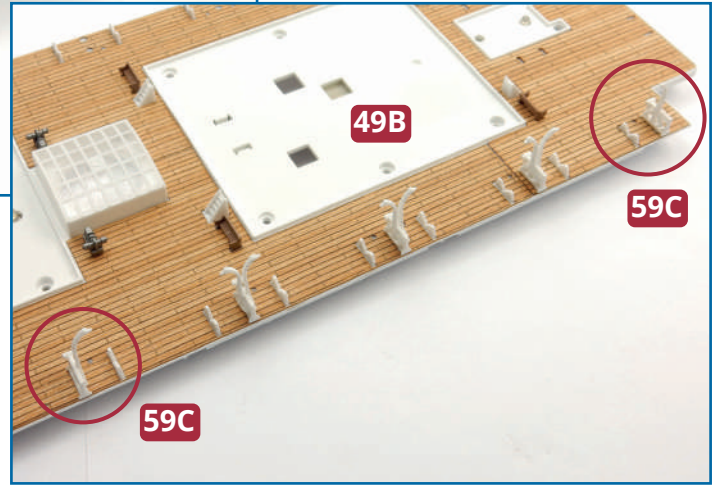
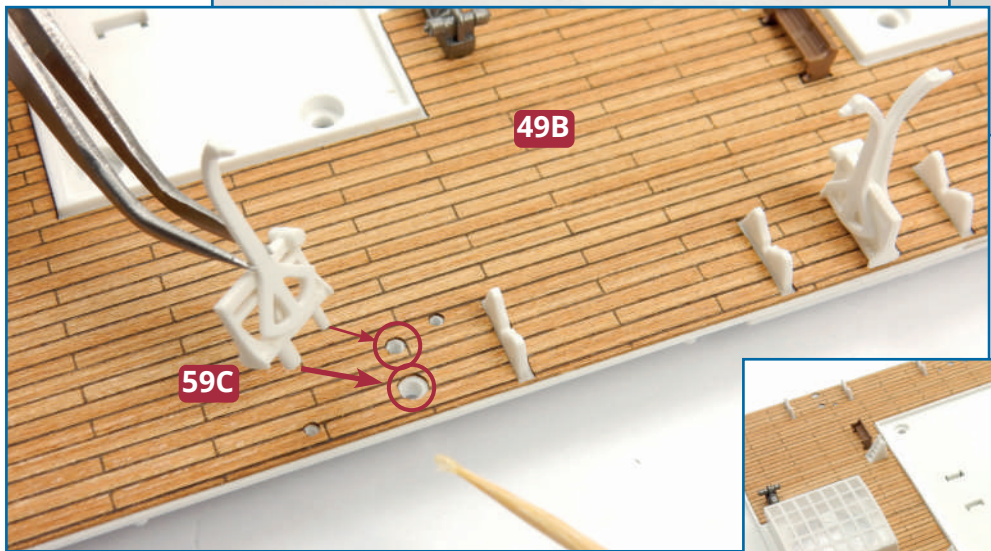
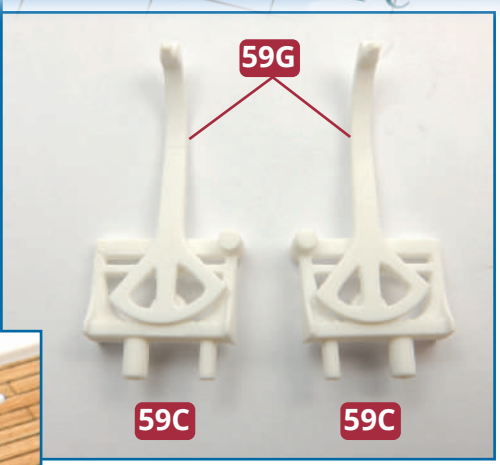

6 Take the two bases D **59C** and two arms C1 **59G**. Glue the arms to the bases, to create two single-sided davits. These are fitted on the port side of the boat deck **49B** as shown. Glue in place.

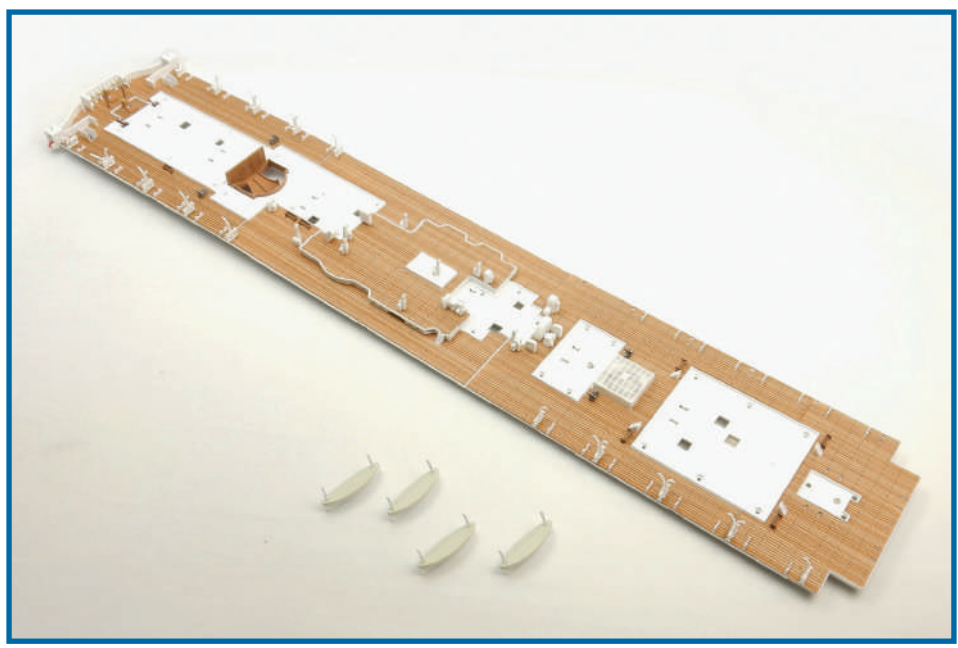

Completed work

Four lifeboats have been assembled, davits have been fitted on the aft port side of the boat deck and three ventilators have been fixed in place.

ENTRANCE TO SECOND-CLASS AREA

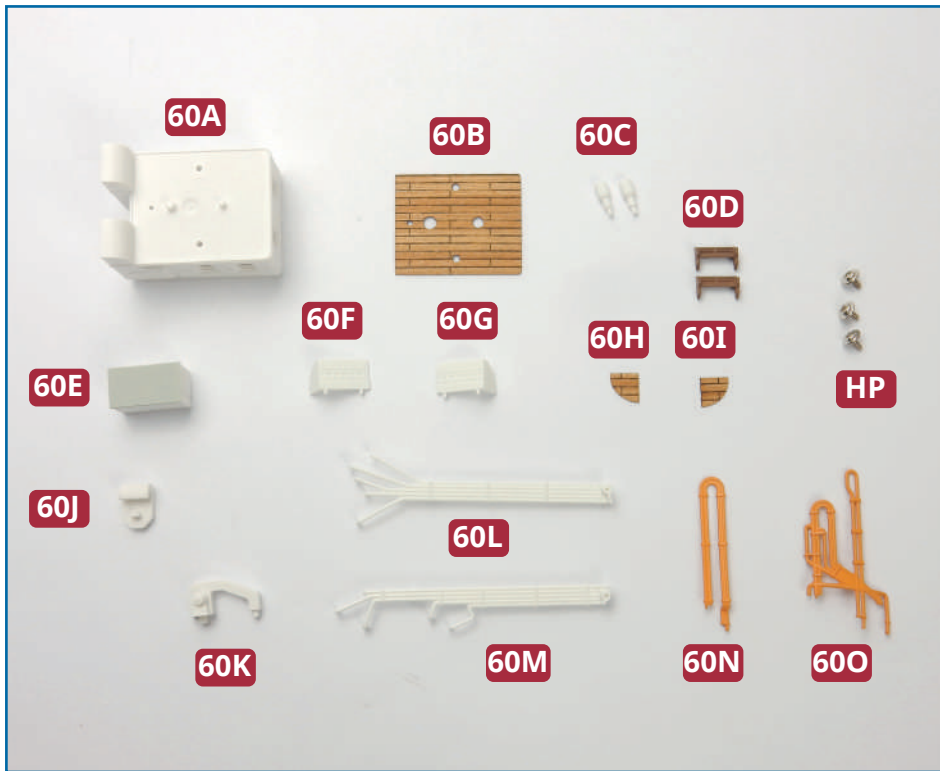

PARTS IN THIS ISSUE

60A Second-class entrance

60B Decking

60C Vent A (x 2)

60D Bench (x 2)

60E Lift engine house

60F Port bulkhead

60G Starboard bulkhead

60H Starboard decking

60I Port decking

60J Vent B

60K Engine for vent

60L Piping A

60M Piping B

60N Piping C

60O Piping D

HP Three 1.7 x 4mm **PWB** screws (1 spare)

1 Take the windows supplied with issue **51**. Remove seven windows **51F** from the frame and identify the fixing points on the second-class entrance **60A**. Glue in place in the openings as shown.

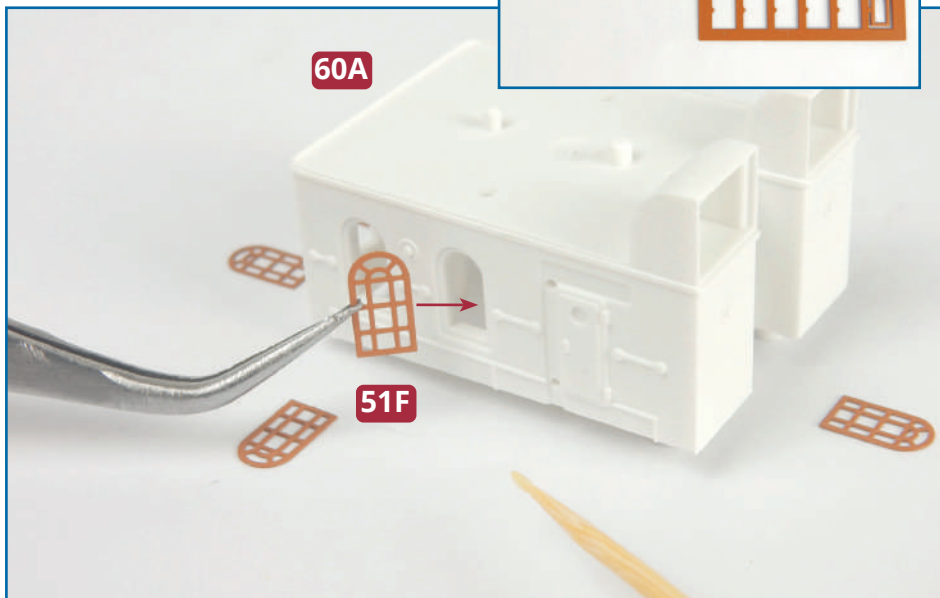
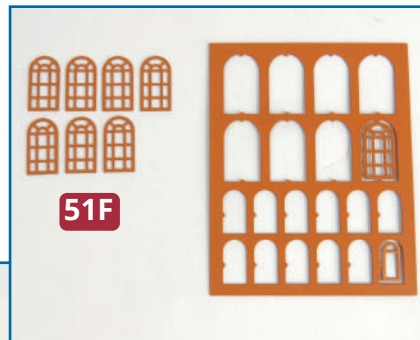

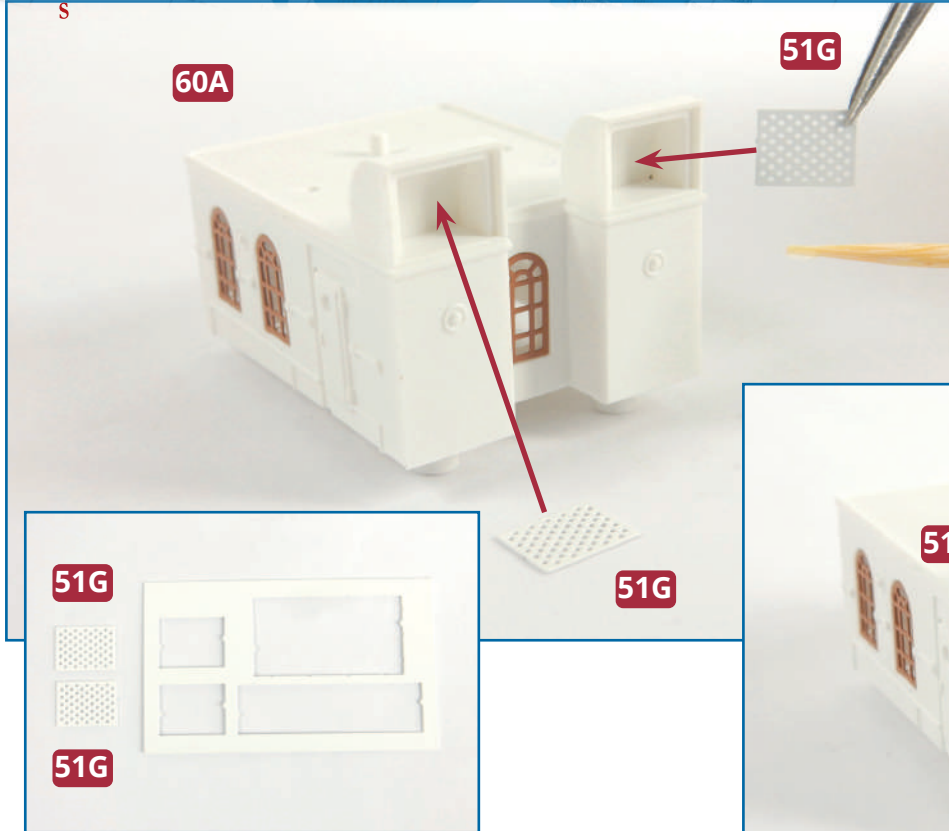
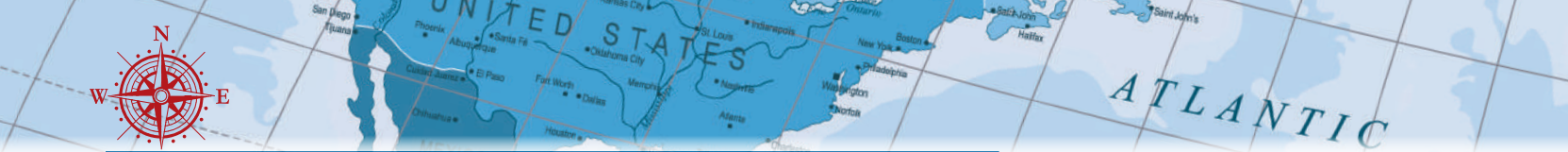

2 Take the two grilles **51G** supplied with issue **51**. Check the fit in the two large openings in the second-class entrance **60A**. Glue them in place.

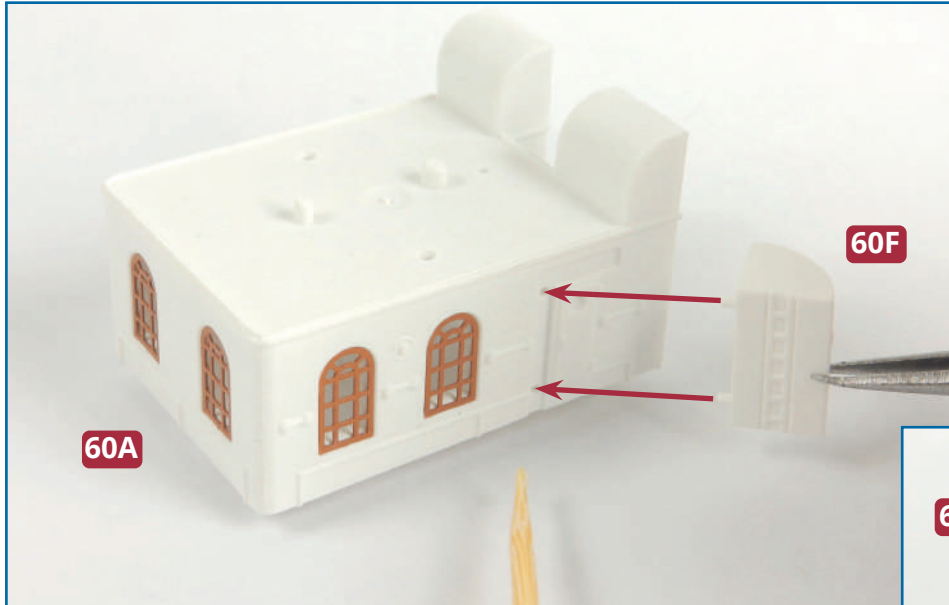
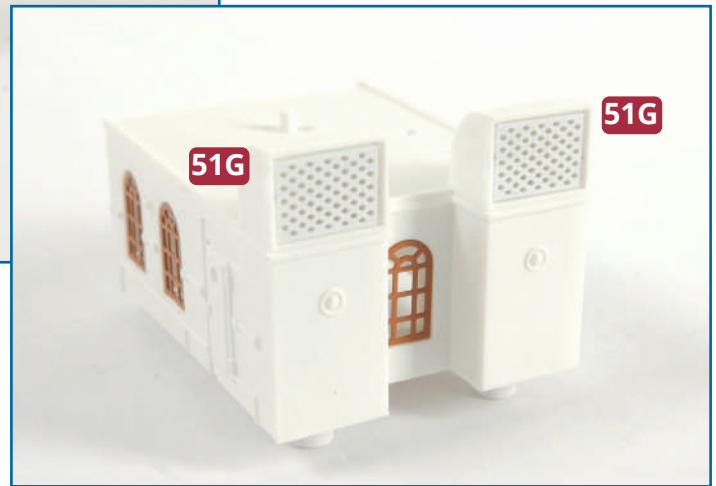

3 Check how the two bulkheads **60F** (port) and **60G** (starboard) fit against the sides of the entrance **60A**. Glue them in place.

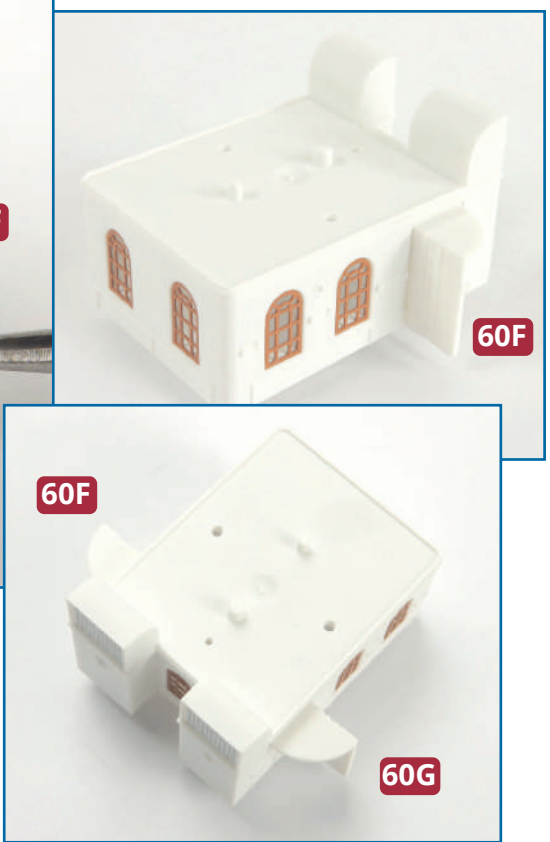

★ STEP-BY-STEP INSTRUCTIONS ★

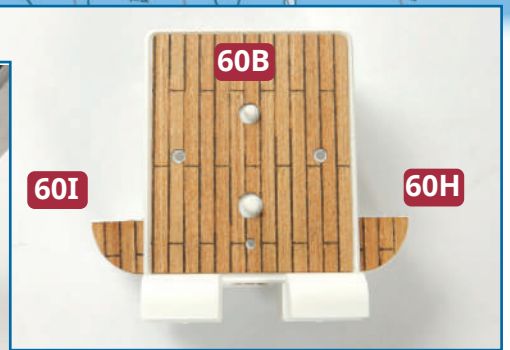
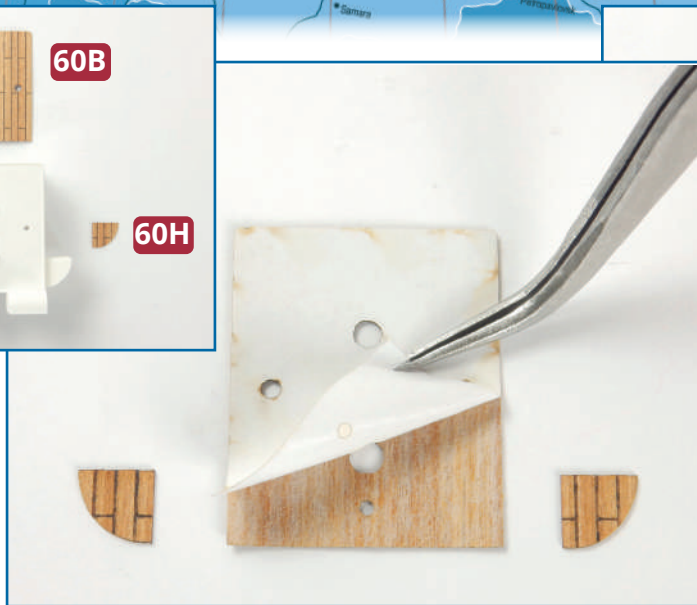
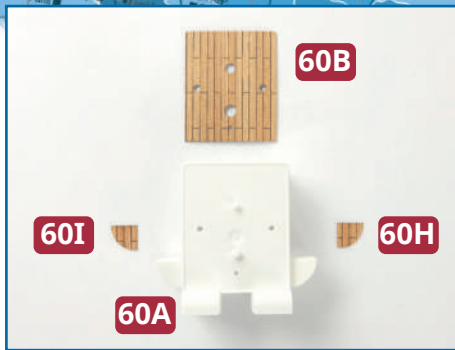

4 Take the decking parts **60B**, **60H** and **60I**. Check how they fit on the top of the entrance and the bulkheads. Remove the backing and fix them in place, smoothing down with a soft cloth.

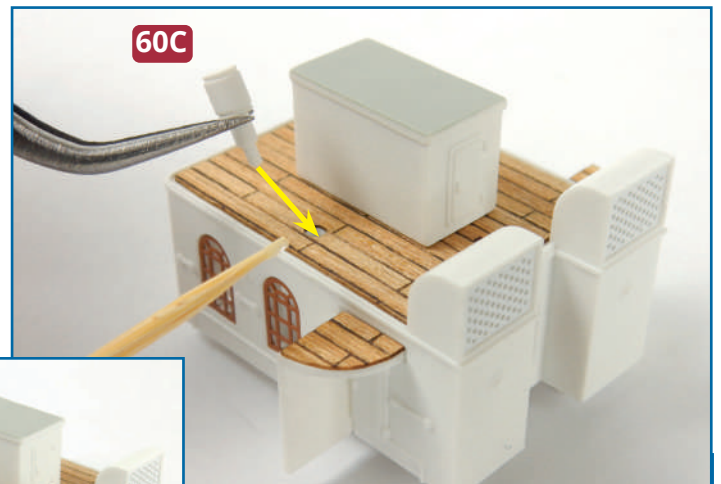
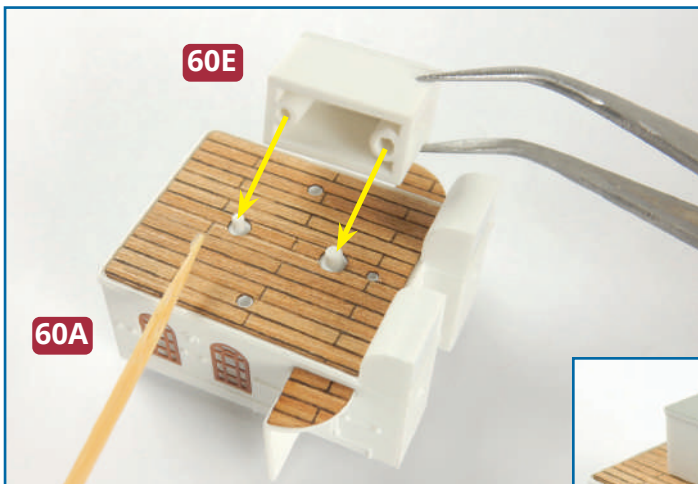

5 Check how the lift engine house **60E** fits on top the entrance **60A**. Note that the pegs on the roof are different sizes and have to fit in the corresponding sockets. Apply a little glue to the pegs to fix in place. Glue the two vents **60C** to the roof of the entrance **60A**.

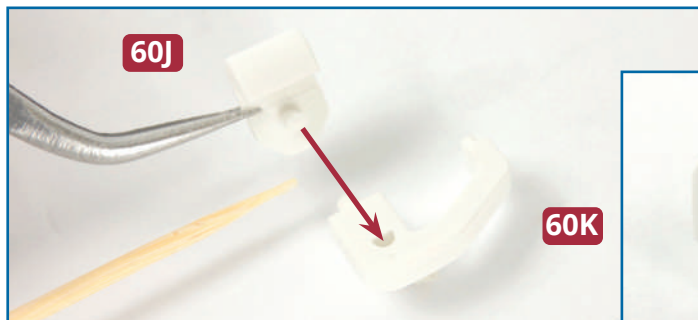

6 Fit the vent **60J** to the vent motor **60K** and fix in place with a little glue.

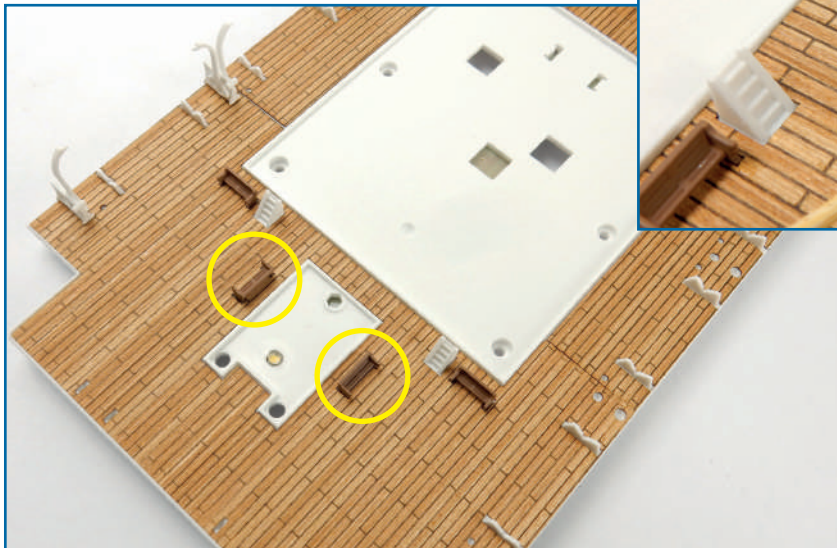
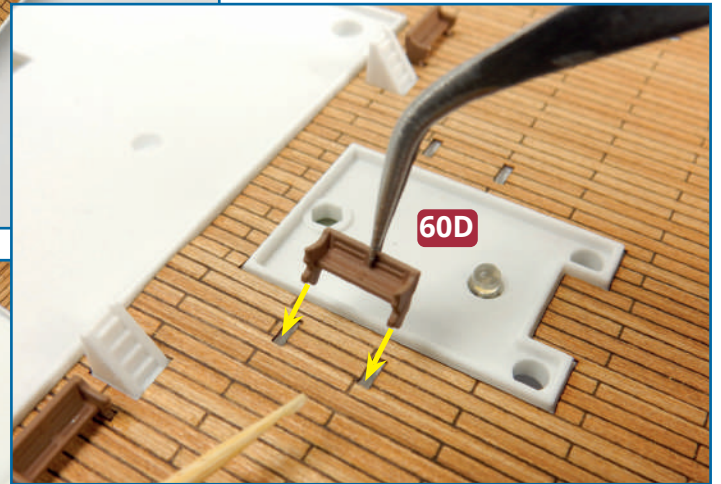
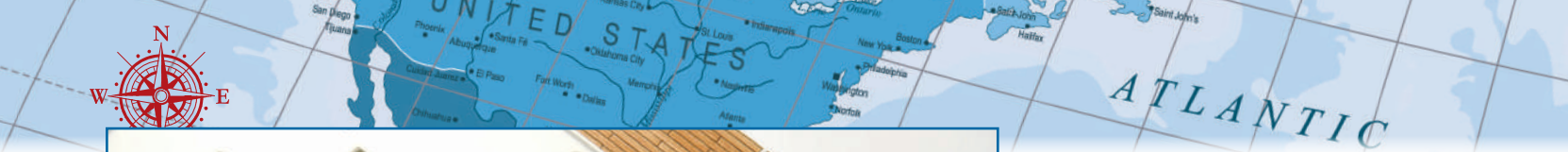

7 Take the two benches **60D** and identify the fixing points at the rear of the boat deck **49B**. Fix in place with a little glue.

Completed work

The second-class entrance has been assembled and benches have been fitted to the boat deck. Store the unused parts carefully until they are needed.

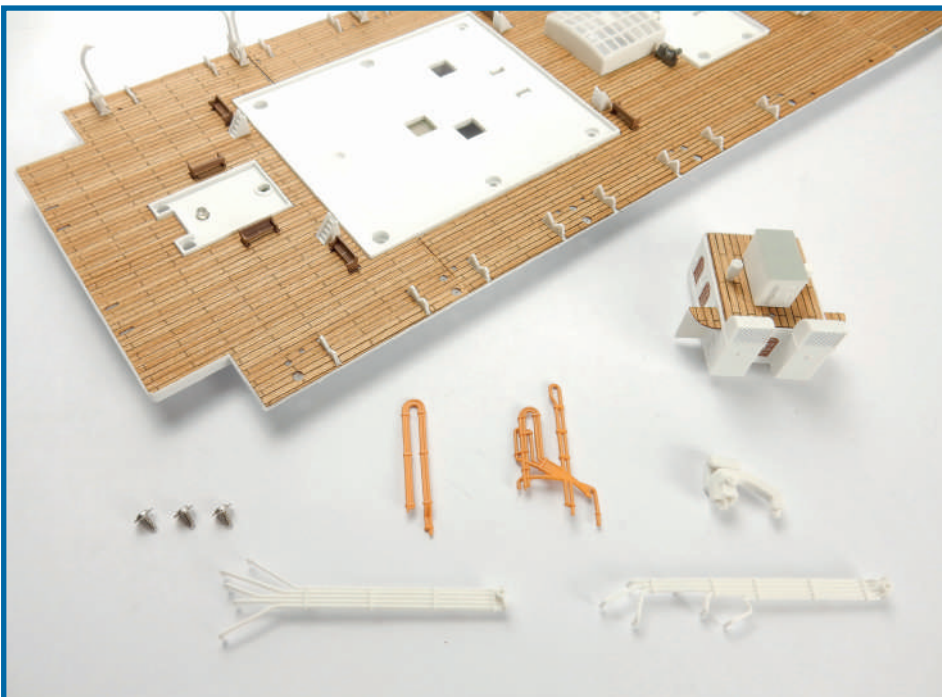

THE FINAL LIFEBOATS

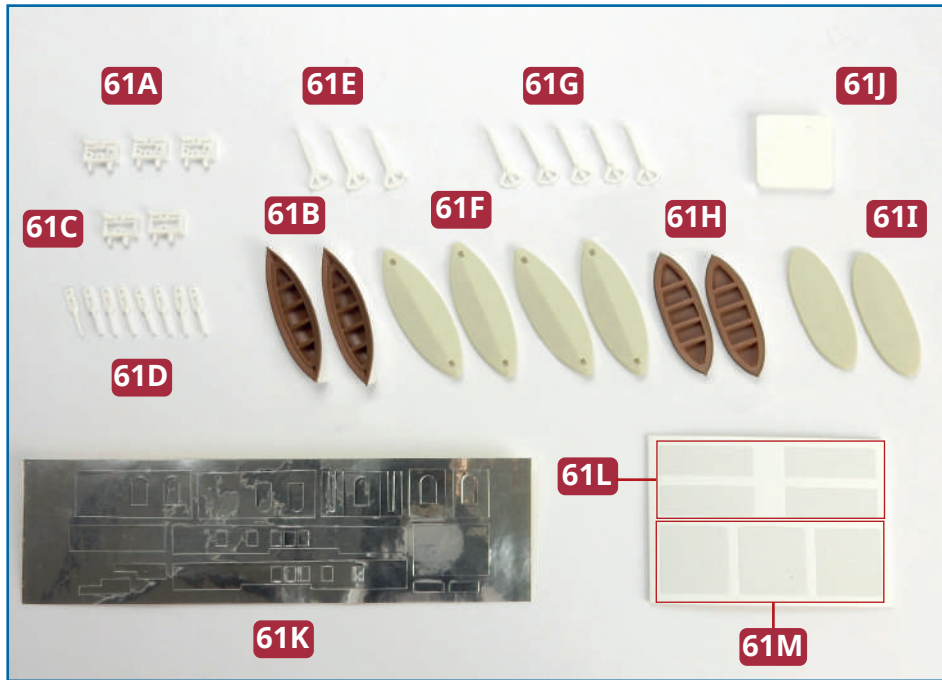

PARTS IN THIS ISSUE

- 61A** Davit base C (x 3)
- 61B** Lifeboats
- 61C** Davit base D (x 2)
- 61D** Lifeboat block gear (x 8)
- 61E** Davit arms C2 (x 3)
- 61F** Tarpaulins (x 4)
- 61G** Davit arms C1 (x 5)
- 61H** Cutters C and D
- 61I** Cutter tarpaulins (x 2)
- 61J** Cover
- 61K** Self-adhesive reflector sheets
- 61L** Self-adhesive strips
- 61M** Self-adhesive squares

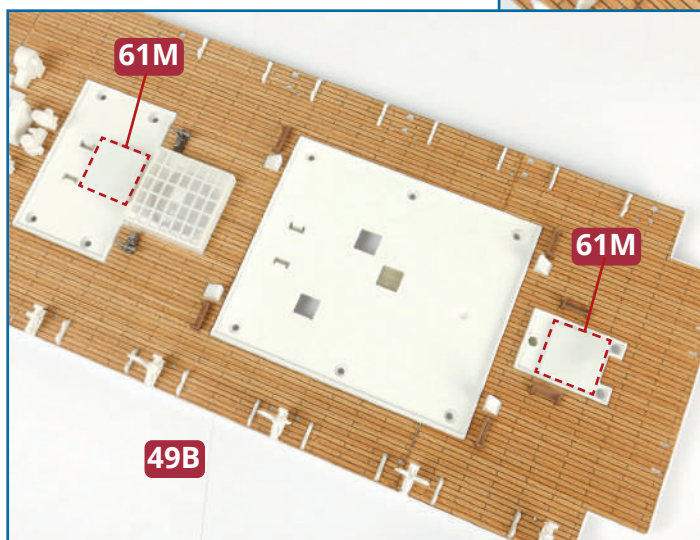
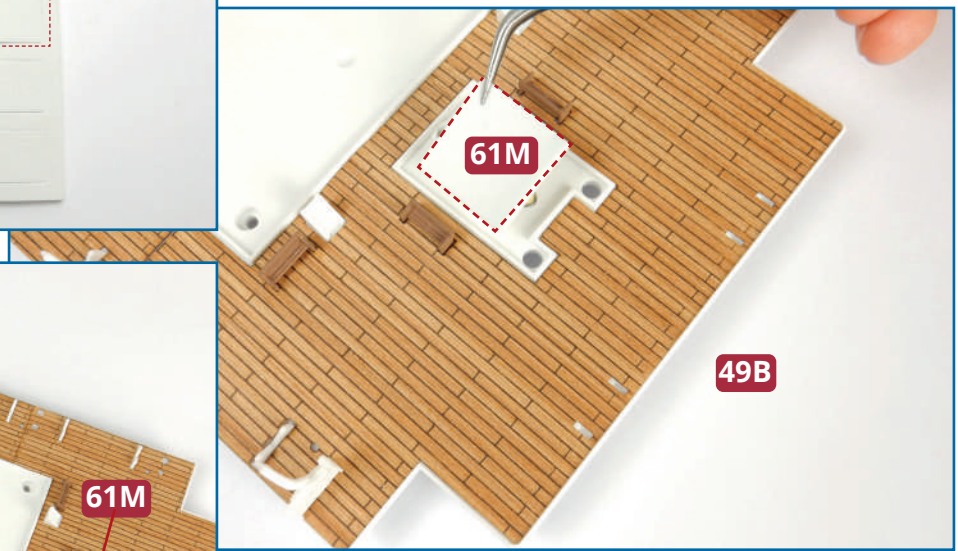
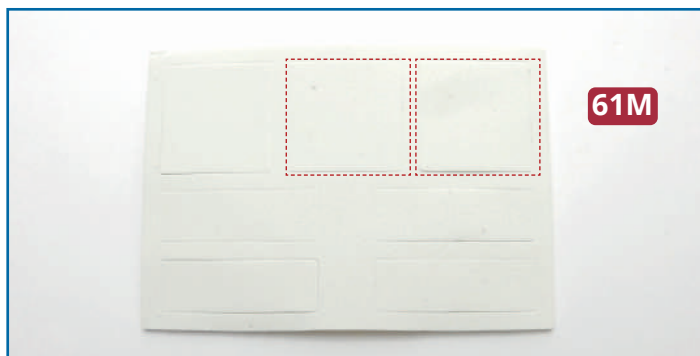

1 Remove two adhesive squares **61M** from the backing and apply them to boat deck **49B** in the positions indicated.

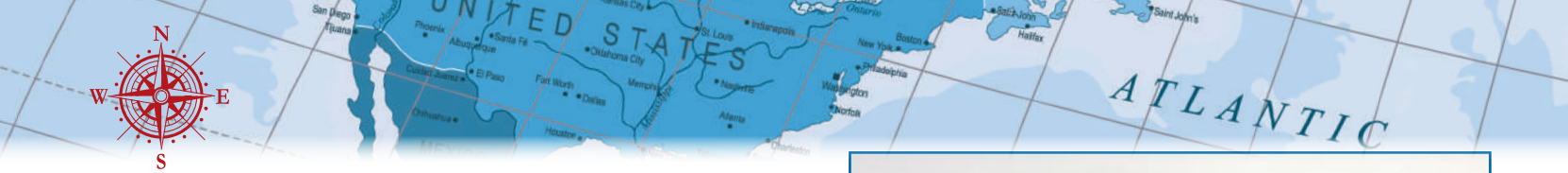

2 Take the second class entrance **60A** and the reflective sticker sheet **61K**. The photograph below shows the stickers removed so that you can identify the shapes easily, and they have been numbered for quick reference. Remove the stickers one at a time as you need them in the following steps.

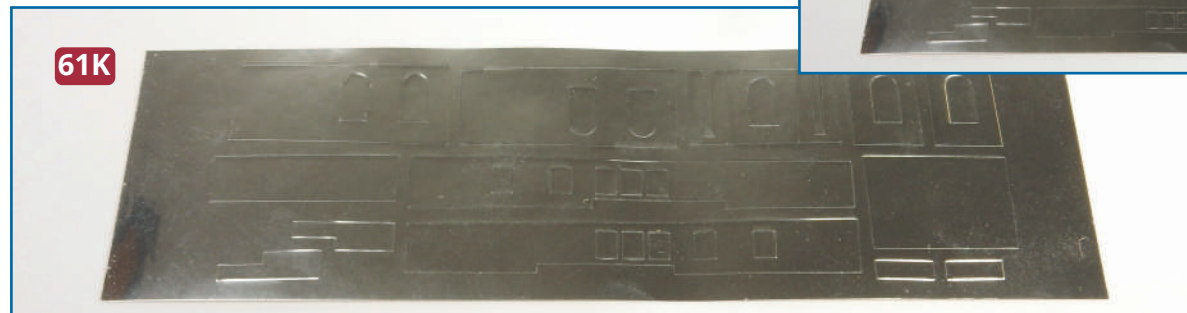
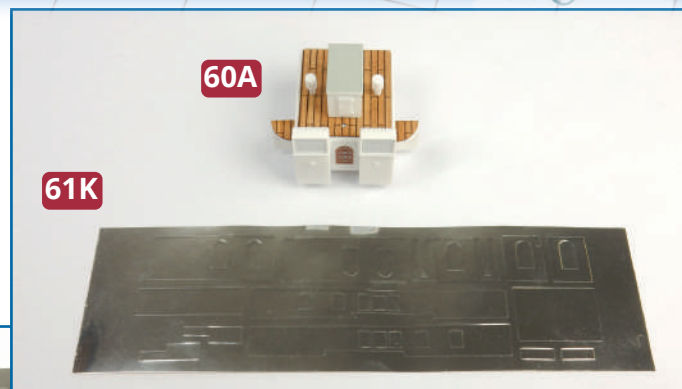

61K

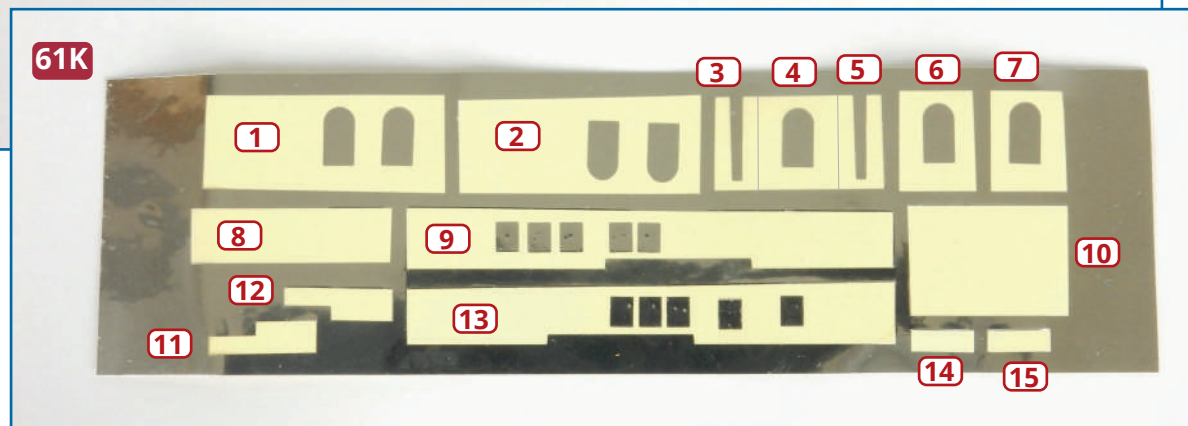

61K

NOTE: The reflective stickers are tricky to fit: you will need to use tweezers to position them and smooth them down. Make sure that they are clear of all the window openings.

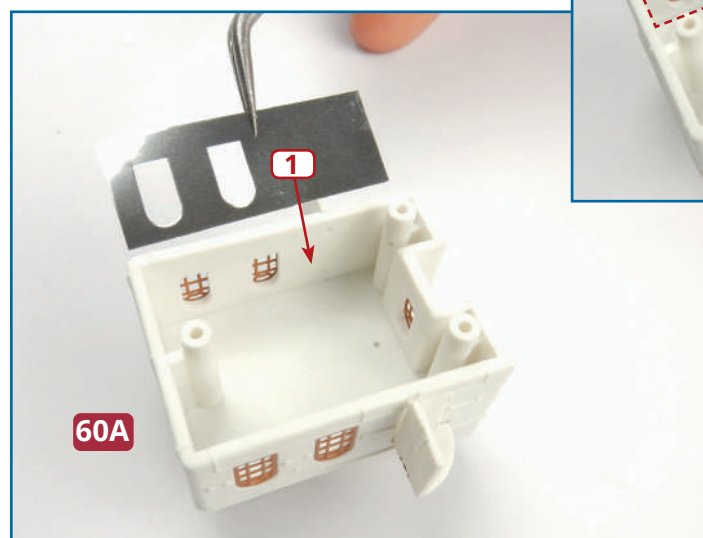

60A

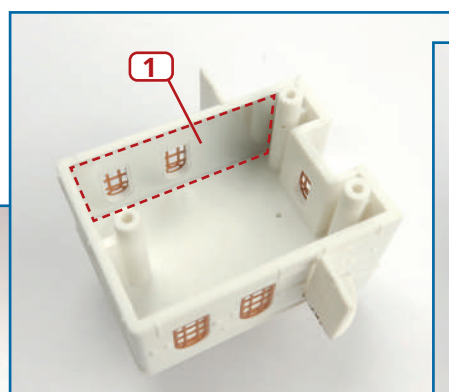

1

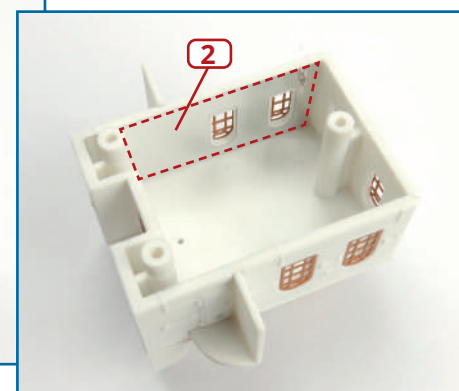

2

3 Turn the second class entrance **60A** upside down and apply stickers **1** and **2** from sheet **61K** inside the two long walls. Take care to align the stickers with the windows.

★ STEP-BY-STEP INSTRUCTIONS ★

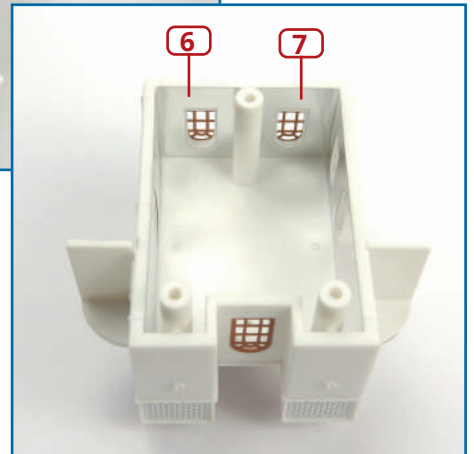
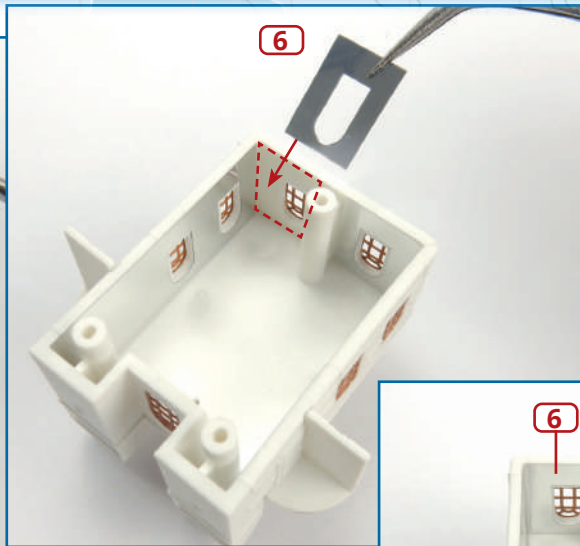
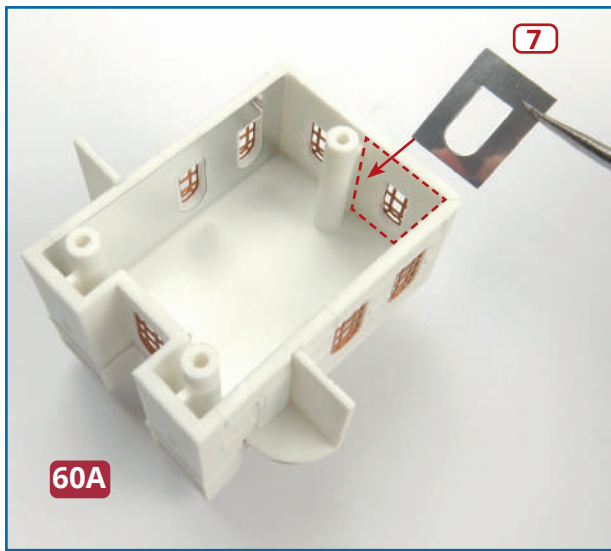

4 Apply stickers **6** and **7** from sheet **61K** along the aft wall of the entrance **60A**.

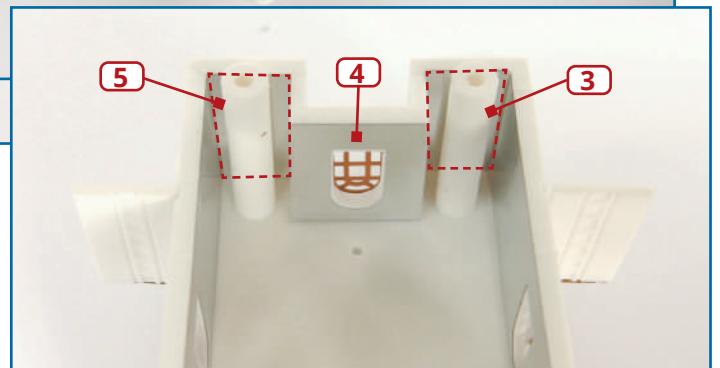
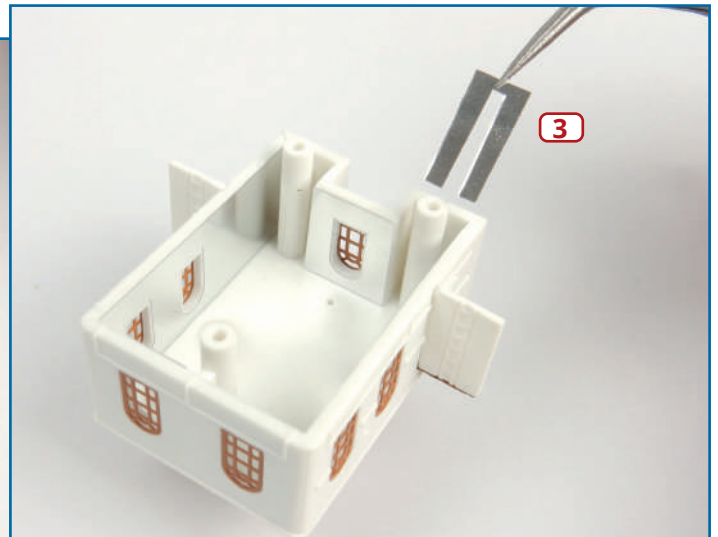
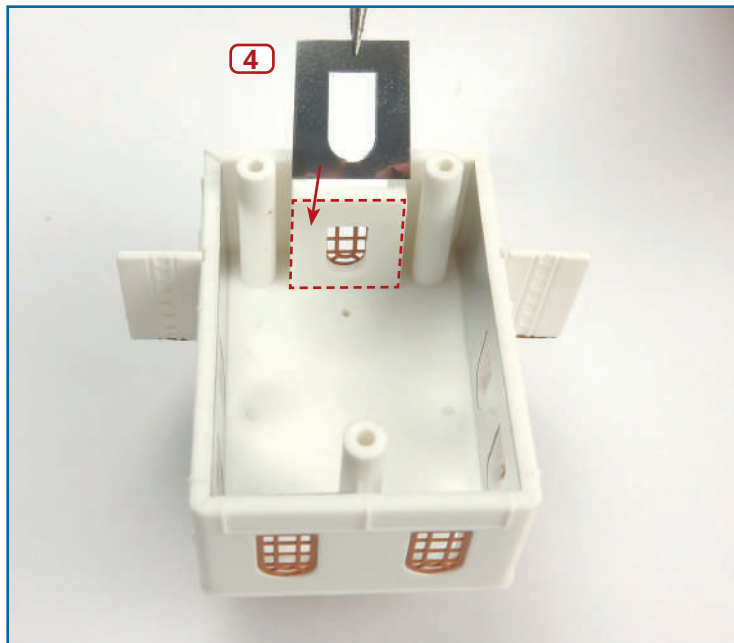

5 Now peel stickers **3**, **4** and **5** from the backing. Apply them inside the second-class entrance, as shown.

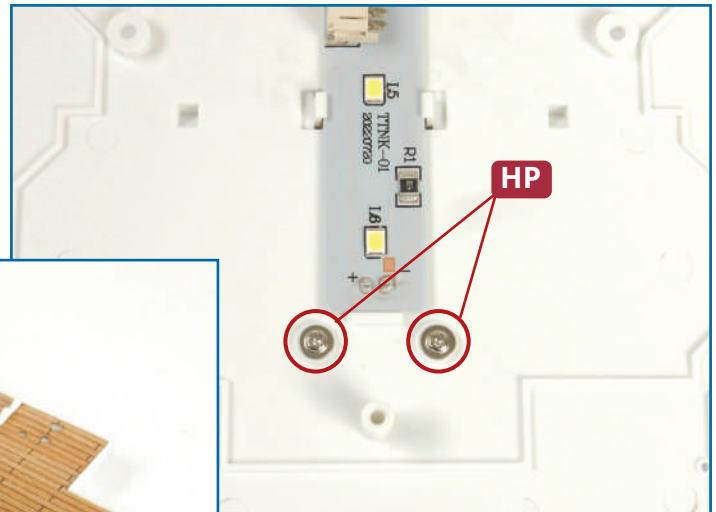
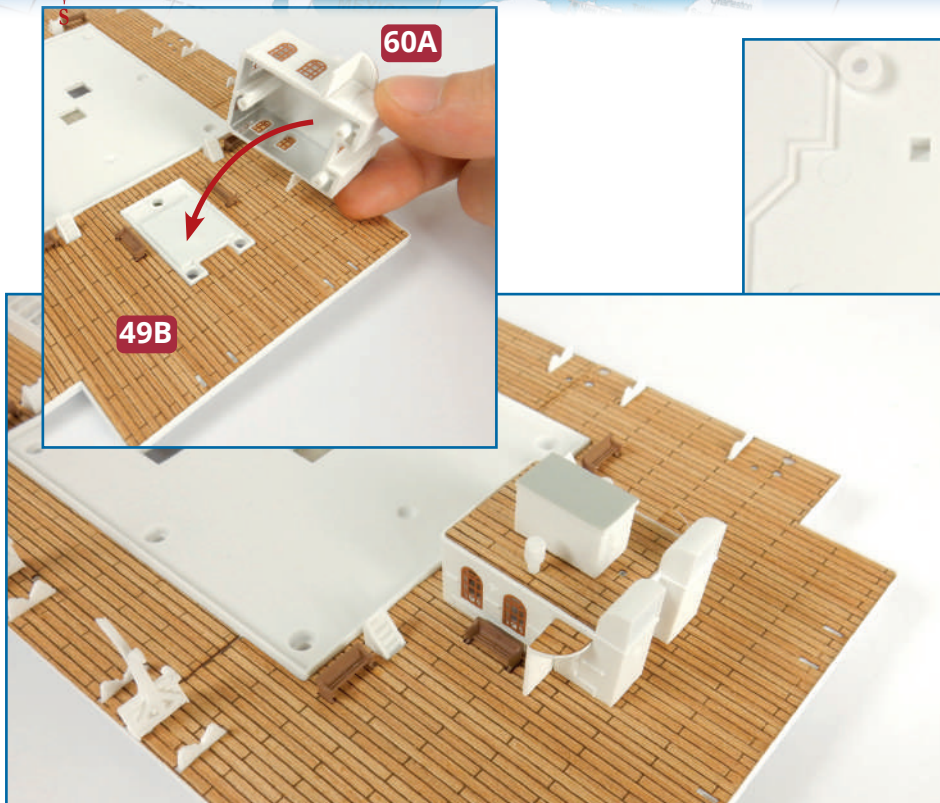

6 Position the second-class entrance **60A** on section **49B** of the boat deck. Turn the deck over so that you can fix it in place using **HP** screws (previously supplied with issue 60).

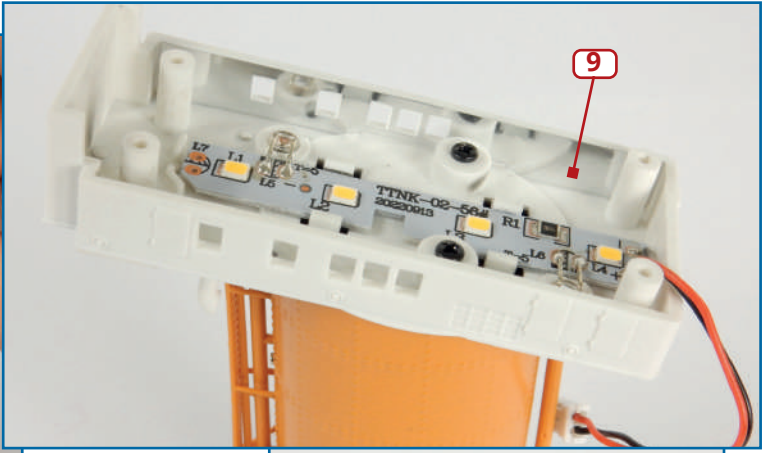
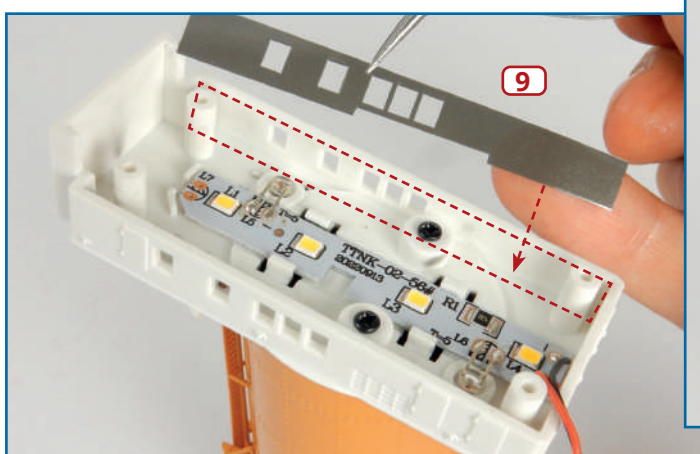

7 Take the base of the fourth funnel **56B** and apply reflective sticker **9** along the inner port side. Apply sticker **11** at one end.

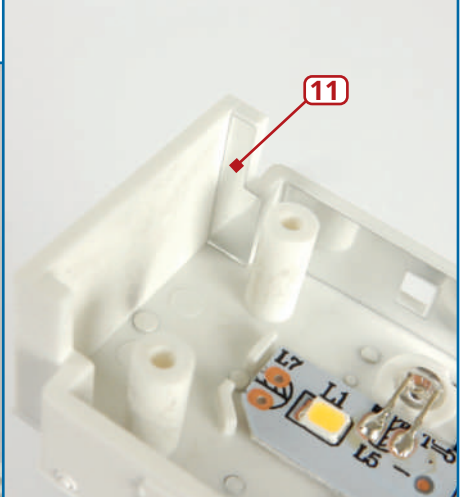
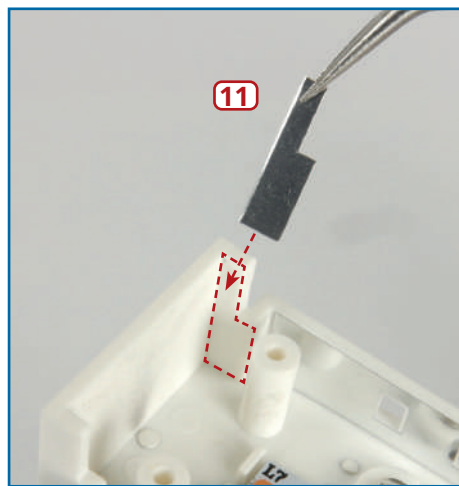

★ **STEP-BY-STEP INSTRUCTIONS** ★

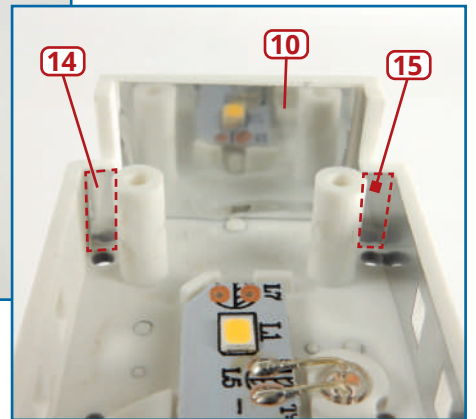
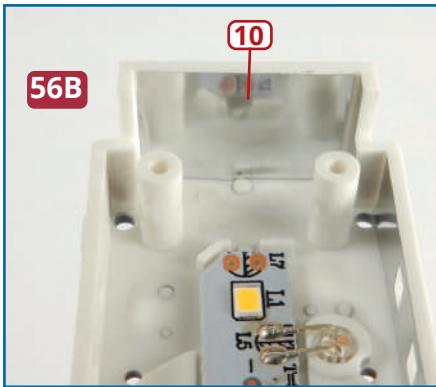

8 One at a time, remove stickers **10**, **15** and **14** from the backing sheet and apply

them to the inside forward end of the base of the funnel, as shown in the above photographs.

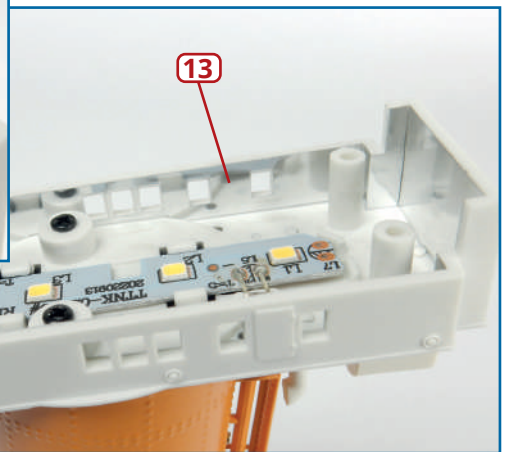
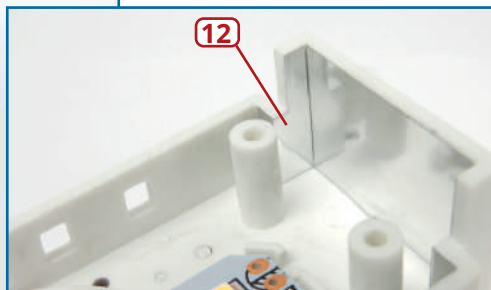
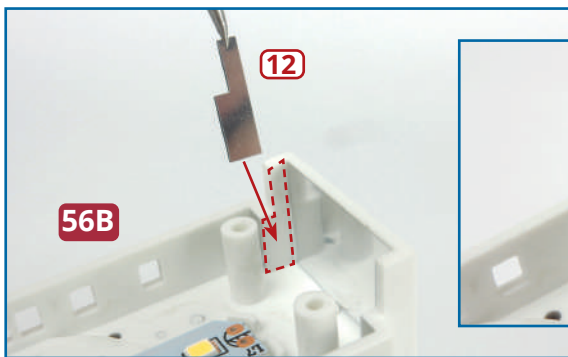

9 Next, fix stickers **12** and **13** inside the starboard wall of the base of the fourth funnel **56B**.

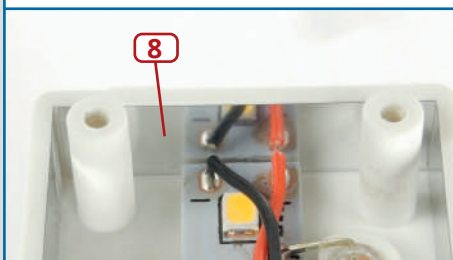
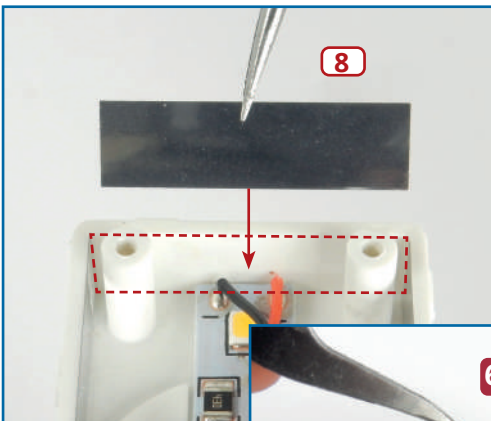

10 Finally, apply the sticker **8** to the aft inside wall and place a white strip **61L** in the centre of the LED board **56A**.

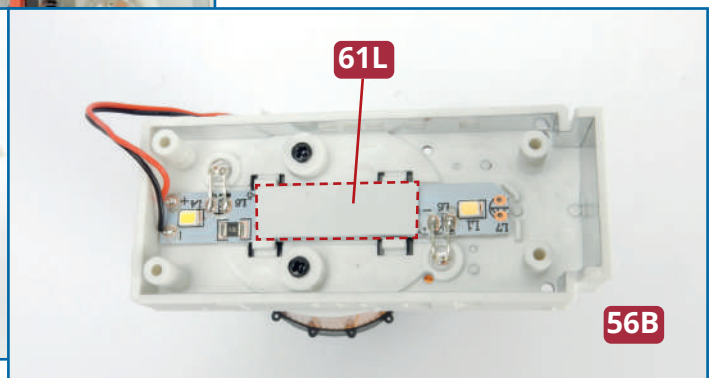
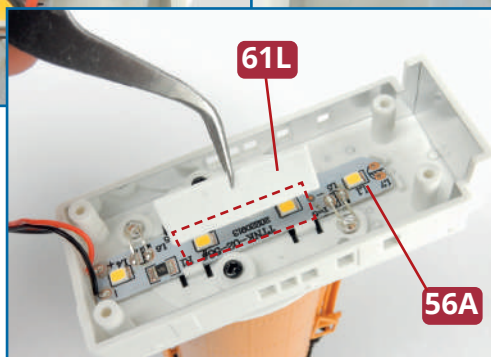



11 Take the first-class smoking room **58B** and check the fit of the base of the fourth funnel **56B** on top of it, as shown below. Note that the electric cable of the circuit board **56A** runs through the rectangular hole in the centre of the smoking room. Fix the base of the funnel in place with four **AP** screws (supplied with issue 58).

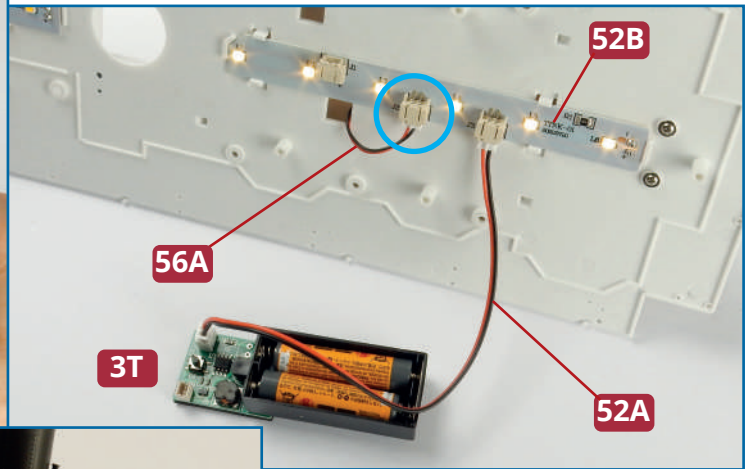
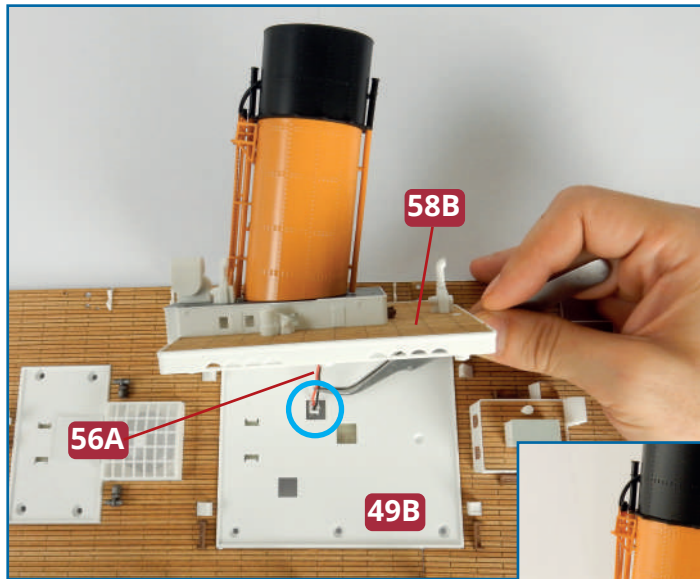
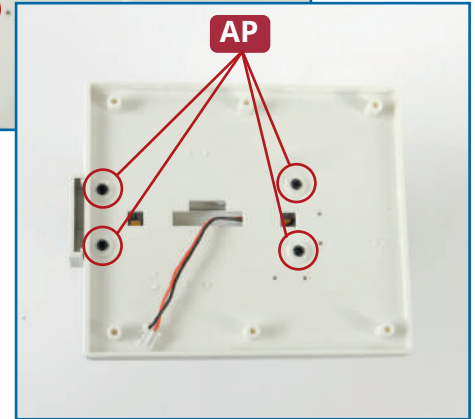
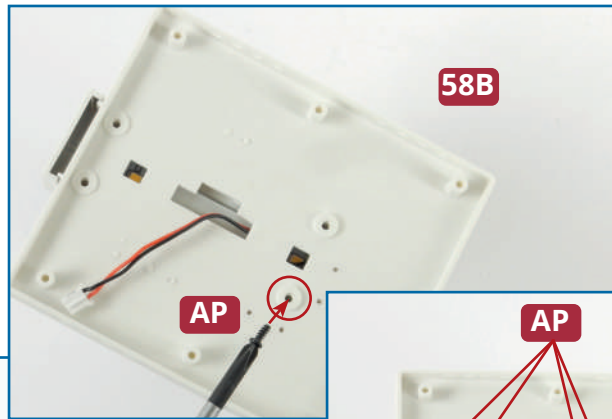
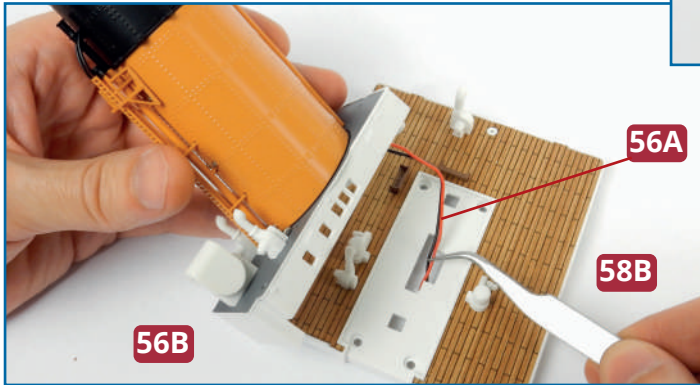

12 Position the smoking room **58B** on the rear section of the boat deck **49B**. Run the cable **56A** through the square hole (circled in blue, above), then fit the plug **56A** into the socket of the LED strip **52B** (circled, above right). Connect the cable **52A** to the tester **3T** to check that the lights are working. Then fix the smoking room to the boat deck with six **AP** screws (supplied with issue 58).

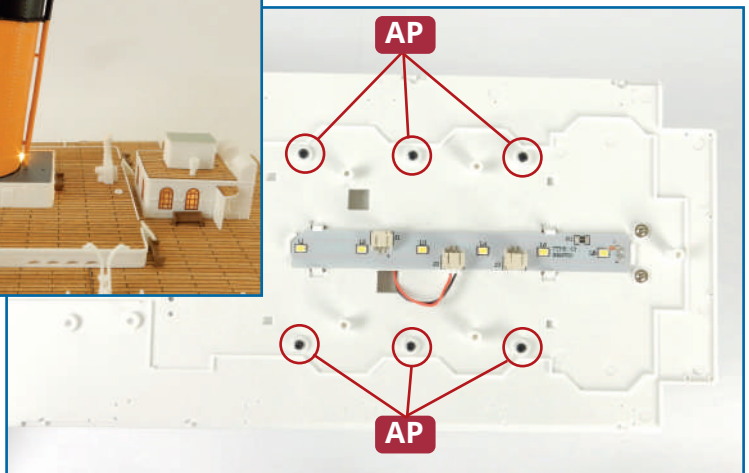
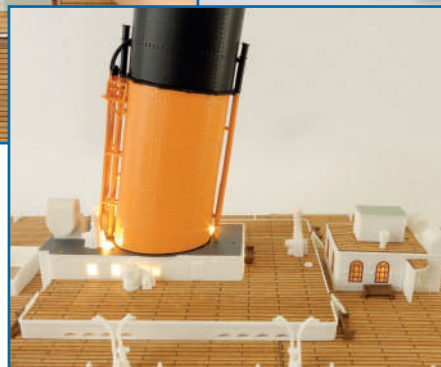

13 Take the three davit bases C (61A), three C1 davit arms (61G) and three C2 davit arms (61E). Glue the arms to the bases as shown, to make three complete double davits. Glue the three davits to the starboard side of the boat deck section 49B. Note that the outer pegs and sockets are larger than the inner ones.

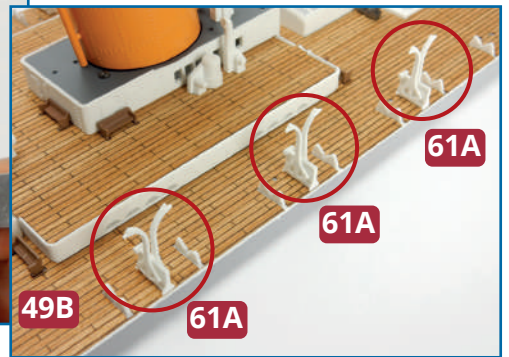
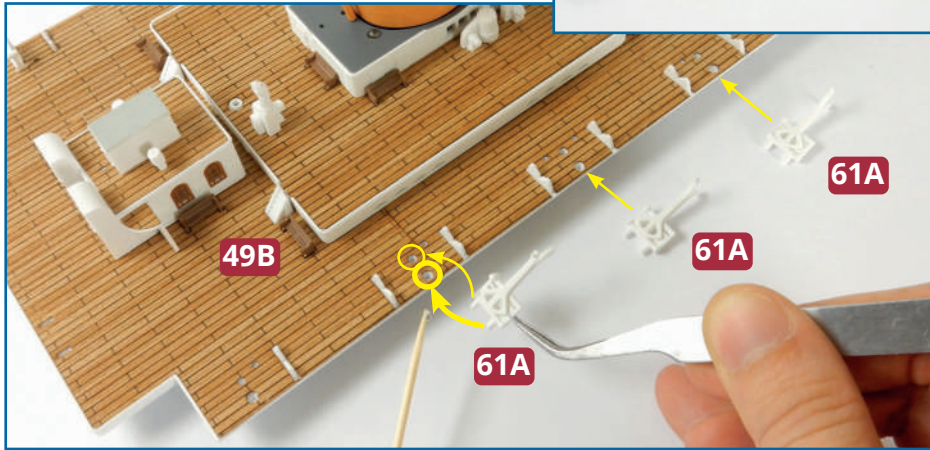
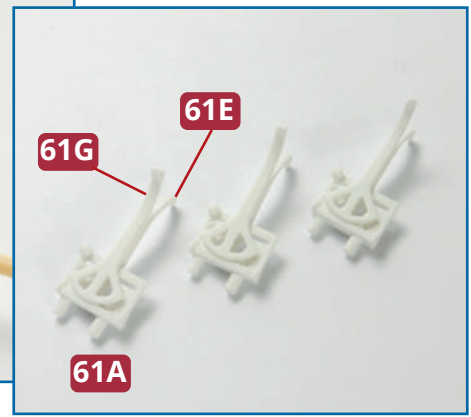
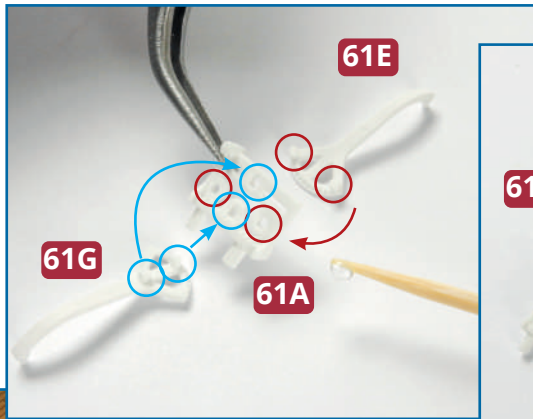

14 Take the two davit bases D (61C) and two arms C1 (61G). Glue the arms to the bases, so you get two complete single cranes. Then position and glue the two cranes on the starboard side of the boat deck section 49B as shown.

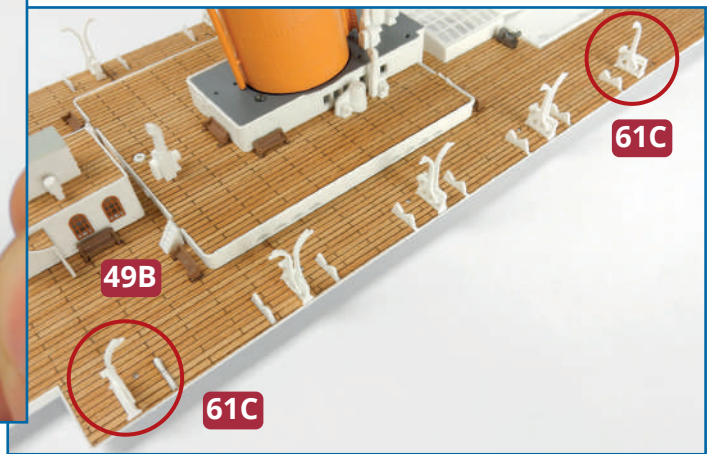
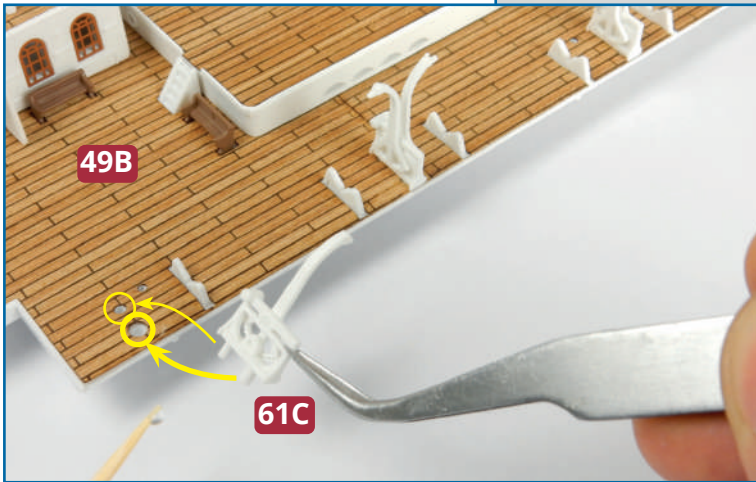
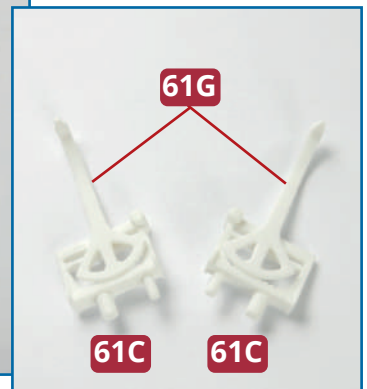
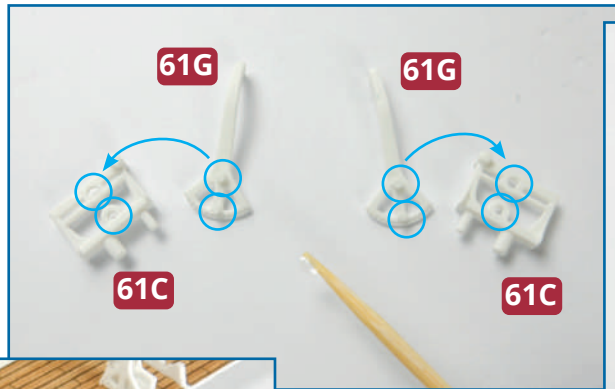

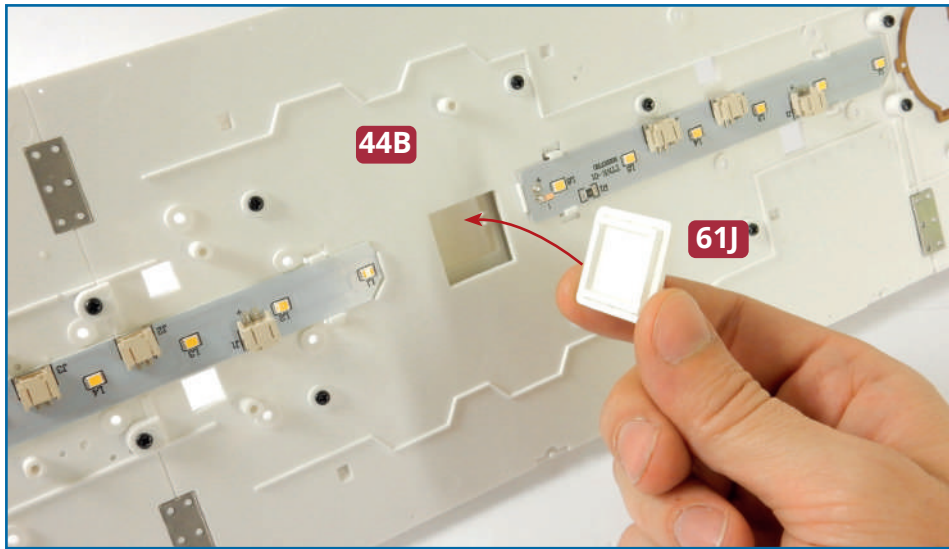

15 Fit the cover **61J** into the square hole located under the centre section of the boat deck **44B**.

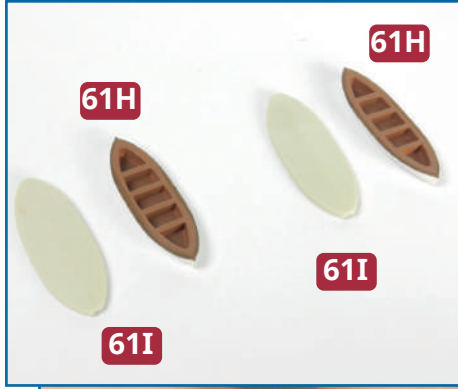
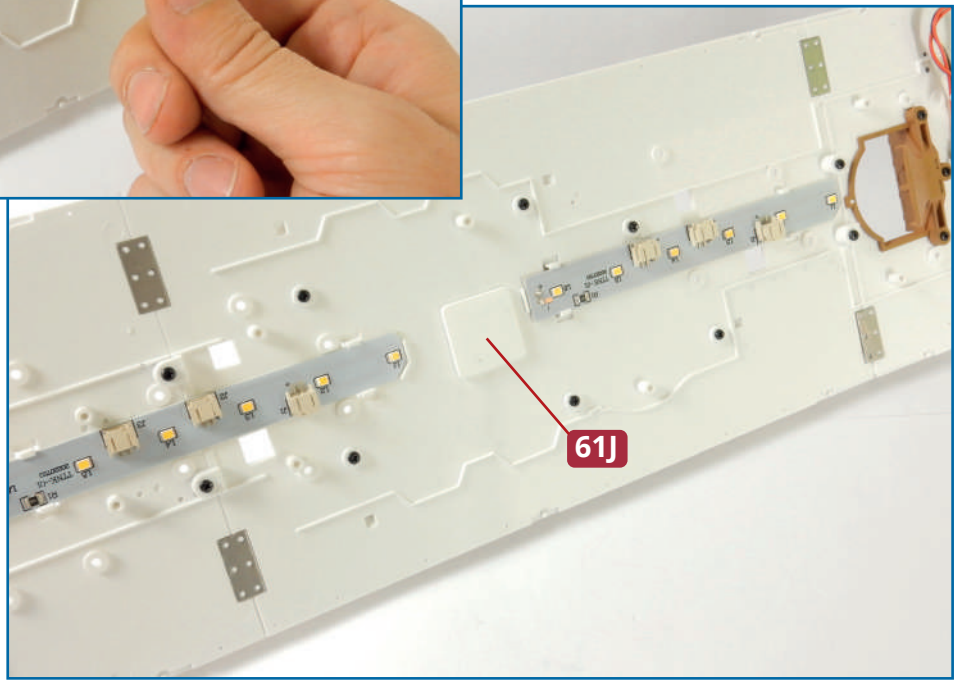

16 Take the two cutters **61H** and the tarpaulins **61I**. Fit the tarpaulins on the cutters, pushing them in place. You do not need to use any glue.

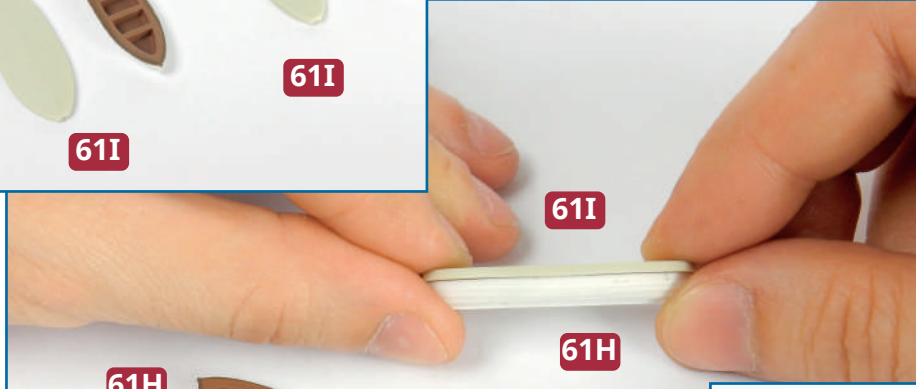

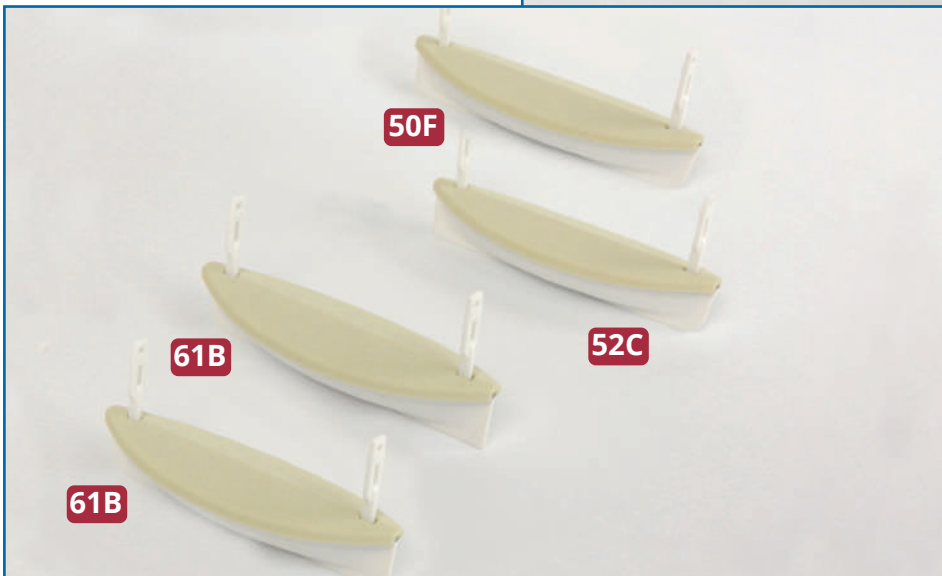
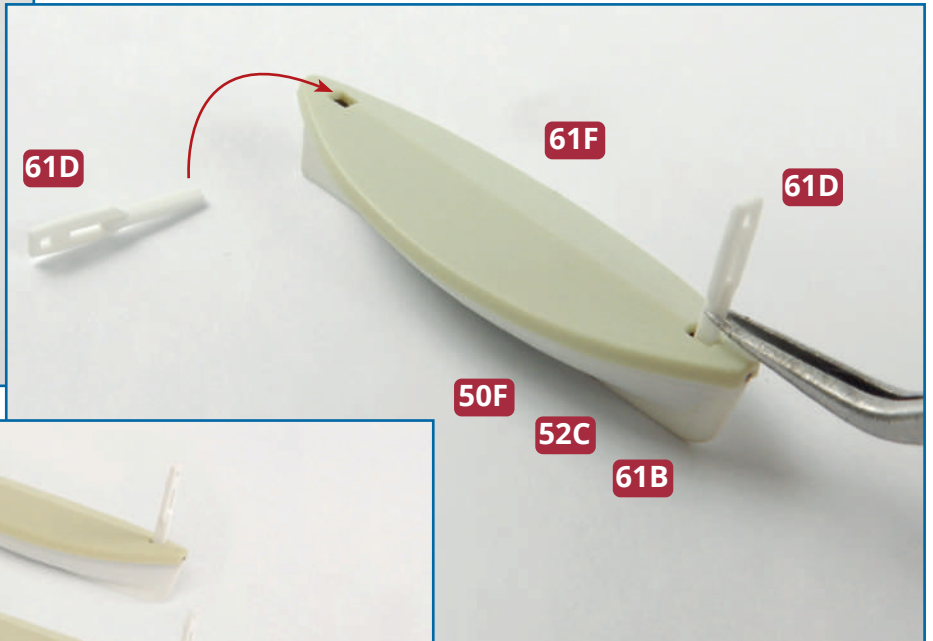
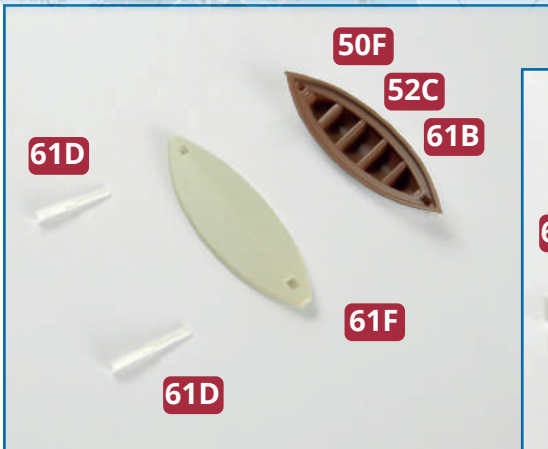

17 Take the two lifeboats **61B**, together with lifeboat **50F** from issue 50 and lifeboat **52C** from issue 52. Fit a tarpaulin **61F** and two block gears **61D** to each of the boats. You do not need to use any glue.

Completed work

The funnel and smoking room have been fitted to the boat deck, along with the last davits. Store the cutters, dinghies and the unused stickers until they are needed.

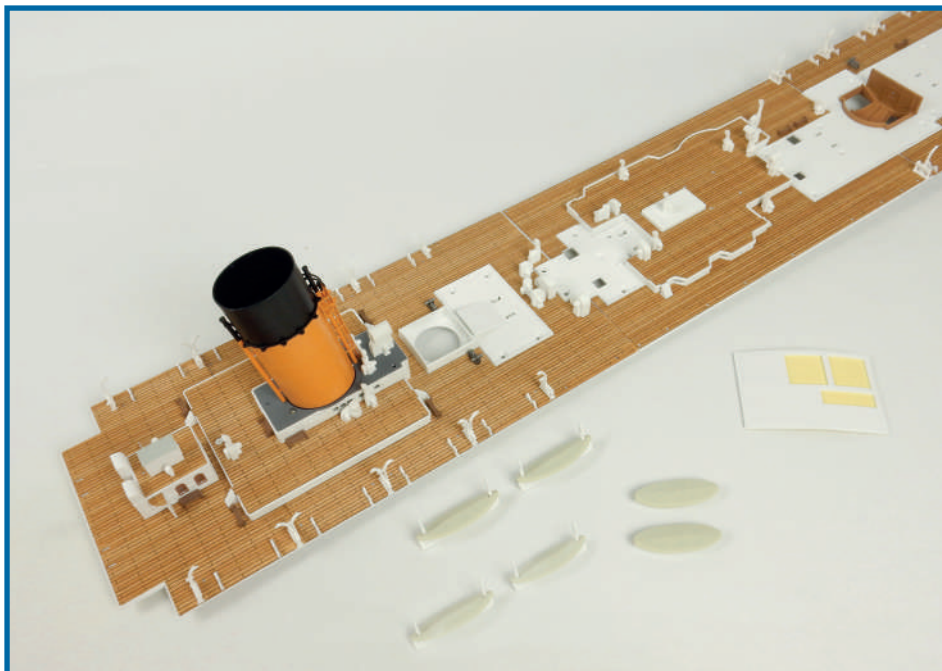

ANOTHER SECTION OF THE HULL



PARTS IN THIS ISSUE

62A Keel section C

62B Bracket

IM Three 2.6 x 3mm PWM screws (1 spare)

AP Three 2.6 x 4mm PM screws (1 spare)

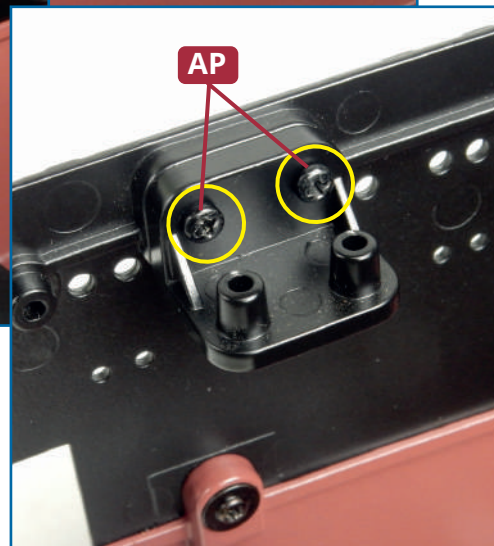
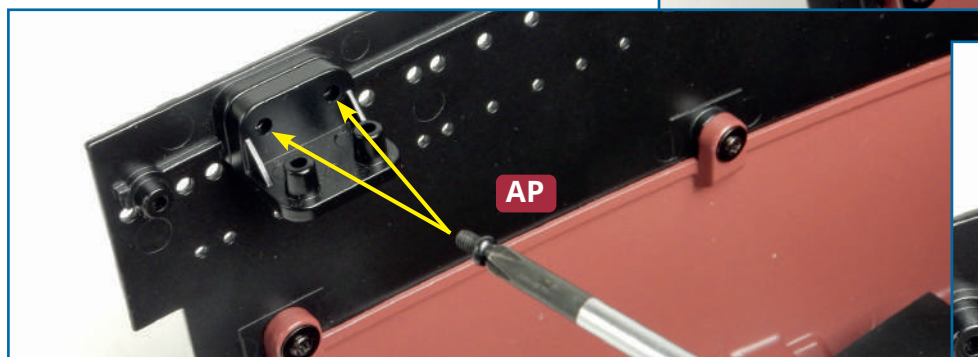
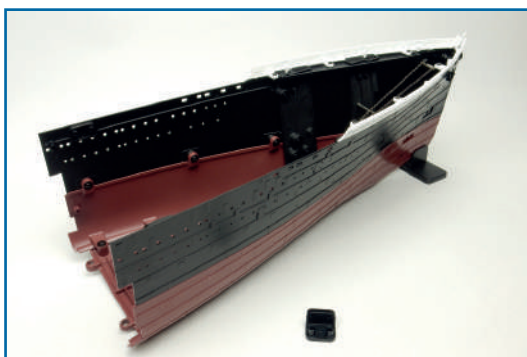

1 Take the hull assembly from issue 24. Identify the position for the bracket **62B** on the hull section **18A** and fit it in place as shown. Fix the bracket with two **AP** screws.

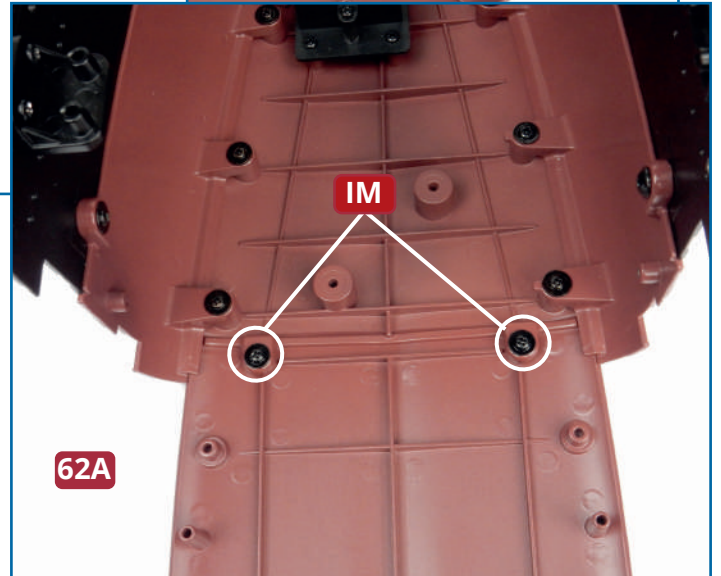
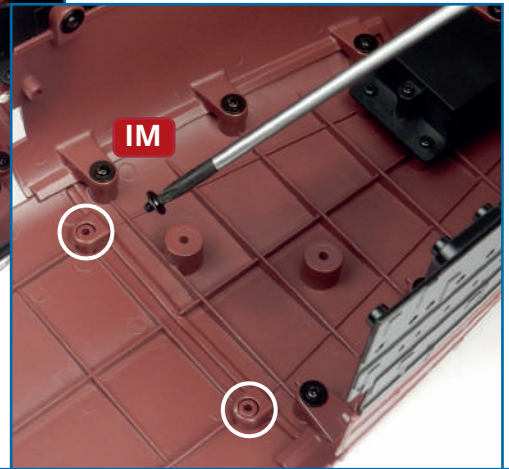
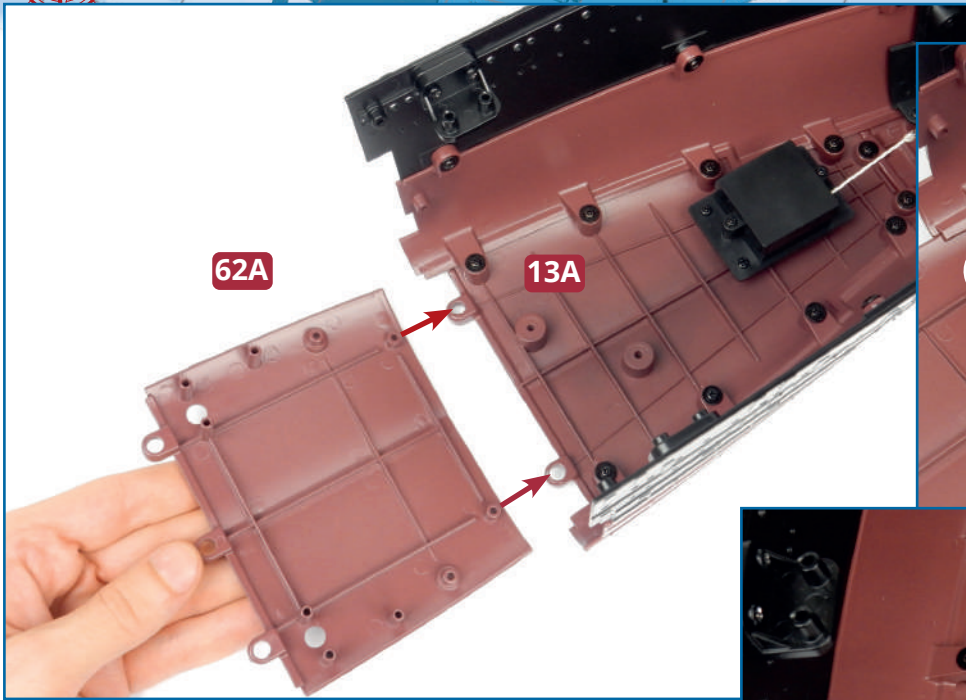
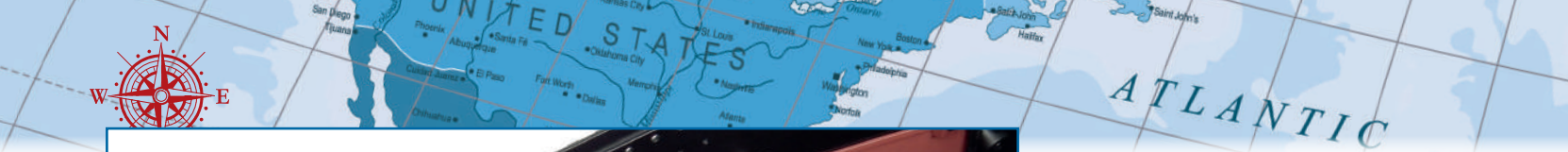

2 Check how the keel section **62A** fits against part **13A**. Fix it in place with two **IM** screws.

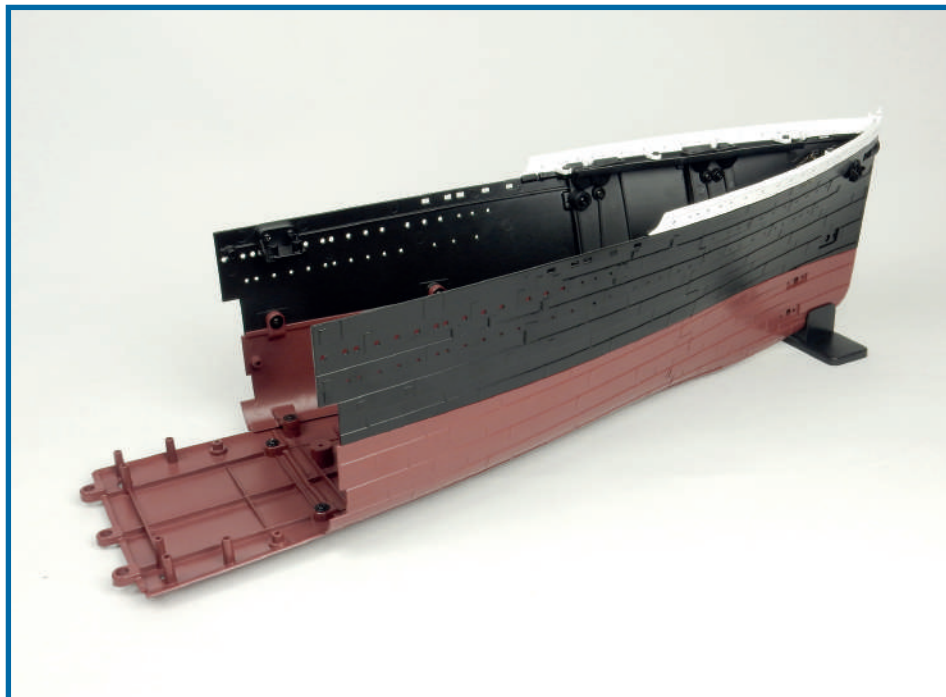

Completed work

Another section of the keel has been fitted to the hull.