

**NO  
TIME  
TO  
DIE** *007<sup>™</sup>*

**DB5**



# Pack 01

## BUILD INSTRUCTIONS

**STAGE 001: ASSEMBLING THE BONNET**

**STAGE 002VB: BUILDING THE FIRST  
WHEEL RIM (EASY-BUILD)**

**STAGE 002: BUILDING THE OUTER  
WHEEL RIM (REGULAR)**

**STAGE 003: BUILDING THE INNER  
WHEEL RIM (REGULAR)**

**STAGE 004: FITTING THE TYRE**

**STAGE 005: BUILDING THE RIGHT DOOR**

**STAGE 006: ASSEMBLING THE RIGHT  
DOOR PANEL**

**STAGE 007: MOUNTING THE RIGHT DOOR  
PANEL AND TRIM**

NO TIME TO DIE © Danjaq, LLC and Metro-Goldwyn-Mayer Studios Inc. NO TIME TO DIE, *007<sup>™</sup>* and related James Bond Indicia © 1962-2023 Danjaq, LLC and Metro-Goldwyn-Mayer Studios Inc. NO TIME TO DIE, *007<sup>™</sup>* and related James Bond Trademarks are trademarks of Danjaq, LLC. All Rights Reserved.



Aston Martin, the Aston Martin Wings logo and the model name "DB5" are trademarks owned, licensed

or used by Aston Martin Lagonda Limited. All Rights Reserved.

AGORAMODELS.

**JAMES BOND**  
—COLLECTION—

## Advice from the experts

---

Spare screws are included with each part. Occasionally, you may be instructed to keep spare or unused screws for a later stage. Keep these spares in a safe place and label them correctly.

Please make sure you don't mix up the screws. They look quite similar, but the threads do vary slightly. Using the wrong screws may damage the parts.

When securing parts together using multiple screws, fit each screw loosely to ensure all the parts are correctly aligned before gently tightening them firmly, but not overtight, in the order in which you placed them.

The screwdriver can be magnetized by stroking it with a magnet (fridge magnet, etc.) enabling it to hold the screws and make assembly easier.

If a screw is tight going into a metal part, do not force it as you may shear the head off. Remove it and put a tiny smear of Vaseline, soap or light oil on the thread. That will lubricate it and make it easier to drive home.

Some parts will require a little glue for assembly. Please apply glue sparingly and use a cocktail stick so that you don't use too much nor apply the glue too heavily. We recommend superglue gel or Extra Thin Liquid modeling glue. Where possible, parts should be test-fitted in place before gluing.

During the course of this build, you will receive many pieces that you will assemble immediately – following the instructions in the corresponding stage – and other pieces that you should store safely to one side, for use in future assembly stages.

Always protect the paint finish on components by placing a cutting mat, sheet of white paper or soft cloth on your work surface.

Left and Right! When building your *No Time To Die* Aston Martin DB5, the left- or right-hand side refers to that side as if you are sitting in the car.



**WARNING:** Some parts are assembled using magnets. These magnets can cause serious injury if they are swallowed. Keep away from children. If you suspect a magnet has been swallowed, seek medical help straight away.

# Stage 001: Assembling the Bonnet

In this stage you'll build the bonnet by attaching the air intake plate, soundproofing material, subframe and fitting the hinges in place. Ensure you have a soft cloth on your work surface to protect the paintwork.



## STAGE 001 PARTS LIST

Name
1-A Bonnet
1-B Bonnet subframe
1-C Air intake plate
1-D Hinge leaf x2
1-E Hinge joint x2
1-F Bonnet lock
1-G Hinge pin x2
1-H Soundproofing material
DS20 screw x8
Screwdriver



## Stage 001: Assembling the Bonnet



Place the bonnet (1-A) with the underside facing you and fit the air intake plate (1-C) in position, pressing the holes in the plate over the pins. Ensure the angled lip on the plate fits into the recess in the bonnet.



Remove the backing paper (inset) from the soundproofing material (1-H) then press the adhesive side onto the bonnet as shown. Start by fitting the front (red arrows) then carefully press down to the bottom edge to align with the three screw posts (circled). Note there is an opening in the material for the air intake (blue arrow).



Take the bonnet subframe (1-B) and note the corresponding fixing points as shown by the arrows. There are also two pins at the side of the bonnet (circled).



Fit the subframe in place on the bonnet, pressing firmly over the two pins highlighted in the previous step. Ensure the fit over these pins is flush.



## Stage 001: Assembling the Bonnet

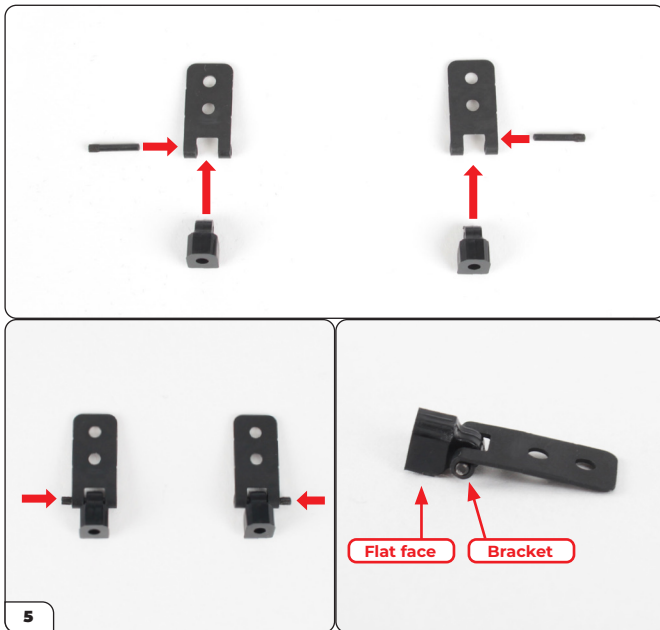

Lay the hinge leaves (1-D), joints (1-E) and pins (1-G) on your work surface as shown. Check that the flat face of the joints and the bracket for the pins are both facing the same direction. Fit the joints into the leaves, then use the pin to connect the parts together, inserting the smooth end of the pin first.

Use a pair of flat-faced pliers to squeeze the ridged end of the pin into the bracket. Repeat with the other hinge so that both pins are flush.

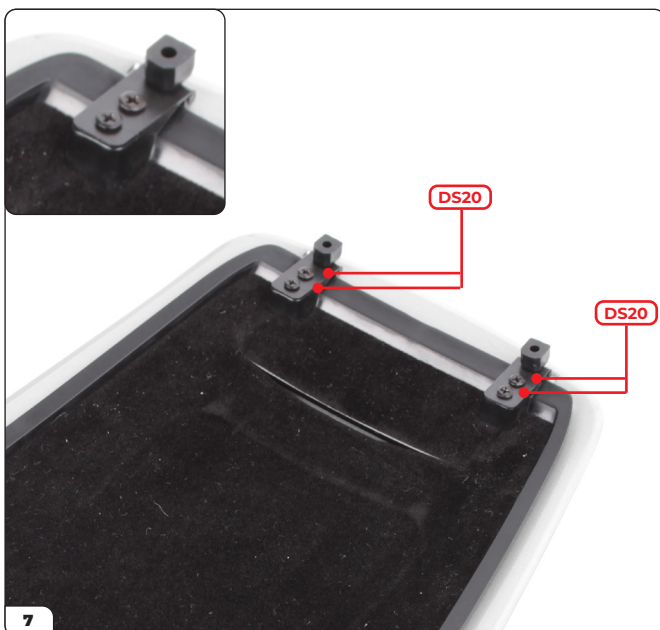

Fit the hinges onto the subframe as shown, checking that the rounded face of the joint faces away from the bonnet. Secure the hinge using 4x DS20 screws.

Use 3x DS20 screws to fix the subframe in place.

## Stage 001: Assembling the Bonnet

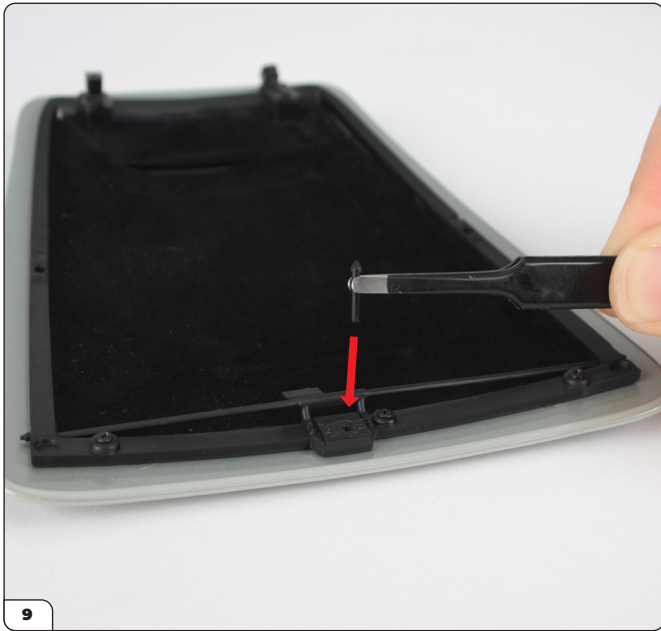

Fit the bonnet lock (1-F) into the hole in the subframe.



## Wheel Options: Easy-Build or Regular

---

The next stages will assemble the first wheel rim.

You have two options for building the wheels on your model – the easy-build or the regular version. The easy-build uses pre-fitted spokes, while the regular version uses individual spokes that thread through the wheel centre.

Below you can see a comparison between the two wheel rims to help you choose. The regular version is built using both Stages 002 and 003, while the easy-build version is built using Stage 002VB.



# Stage 002VB: Build the First Wheel Rim (Easy-Build)

This stage is the easy-build version of the wheel rim. If you choose to use this version, move straight to Stage 004 after completing it.



## STAGE 002VB PARTS LIST

Name
2VB-A Outer spokes
2VB-B Inner wheel rim
2VB-C Outer ring
2VB-D Inner spokes
2VB-E Outer wheel rim
2VB-F Wheel hub back
2VB-G Inner ring
2VB-H Spoke retainer ring
2VB-I Wheel hub front
PS02 screws x9
PS03 screws x4
PS32 screws x4

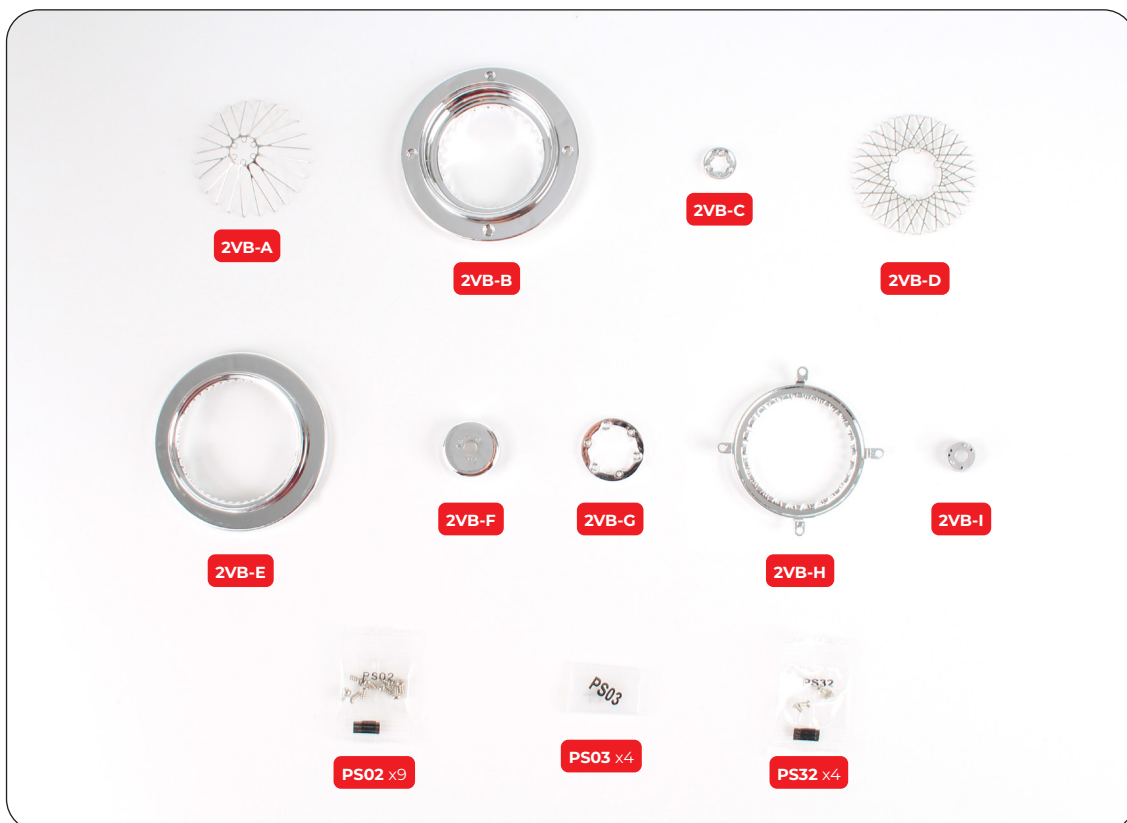



## Stage 002VB: Build the First Wheel Rim (Easy-Build)



1  
Line up the wheel hub front (2VB-I), outer spokes (2VB-A) and outer ring (2VB-C) as shown, then position the outer ring on top of the spokes.

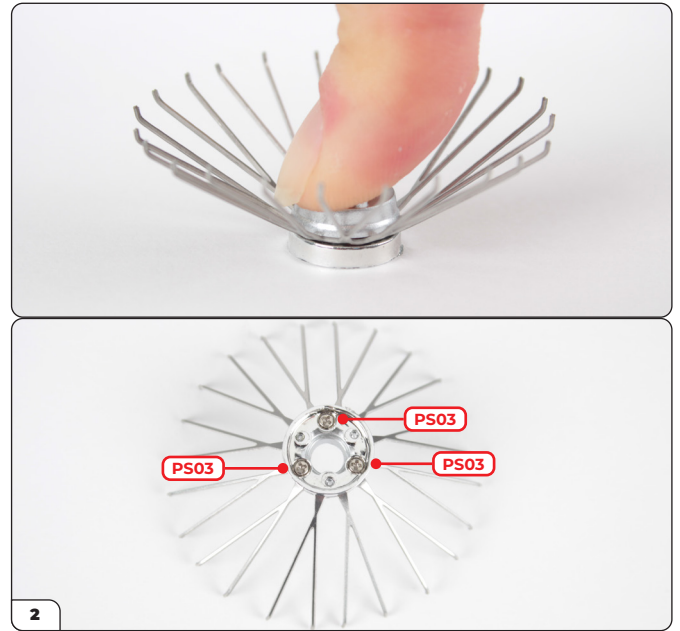

2  
Turn the spokes over and press the pins on the wheel hub front into the smaller holes on the outer ring. Secure using 3x PS03 screws.

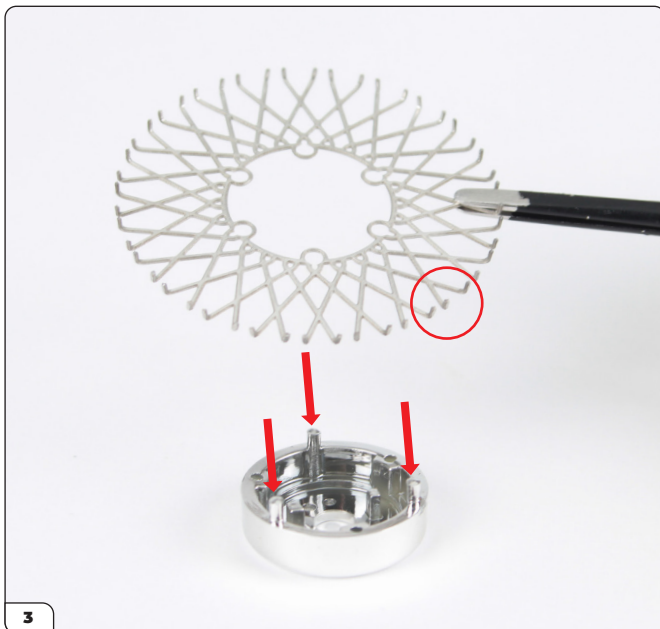

3  
Place the inner spokes (2VB-D) with the ends pointing up (circled) onto the three pins on the wheel hub back (arrows).

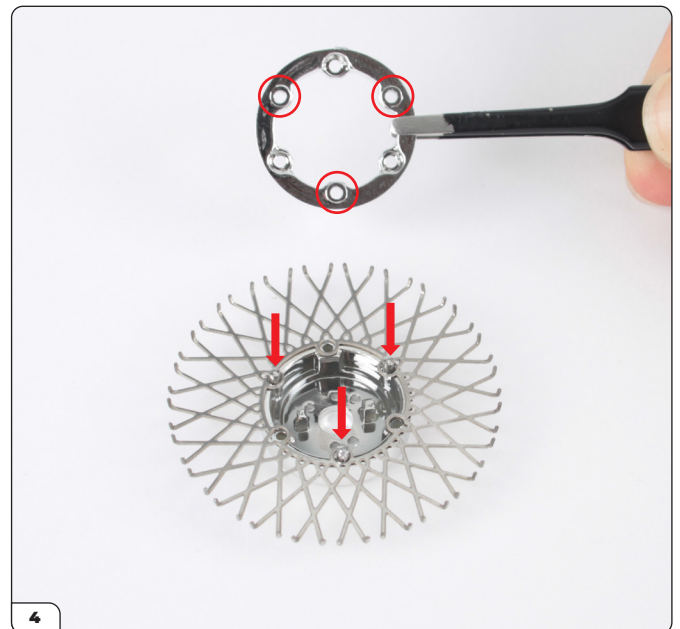

4  
Press the inner ring (2VB-G) on top of the spokes using the three holes without a recess (circled). If any holes are covered with paint, simply poke through using a knife or needle.



## Stage 002VB: Build the First Wheel Rim (Easy-Build)

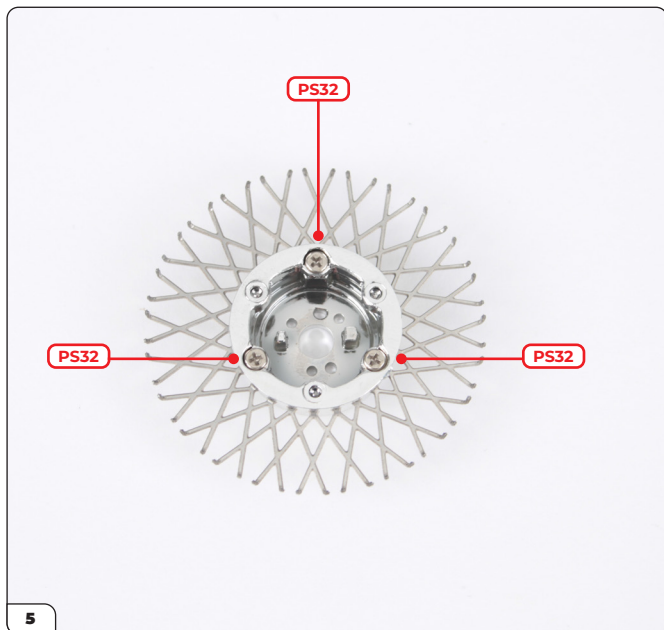

Secure using 3x PS32 screws.

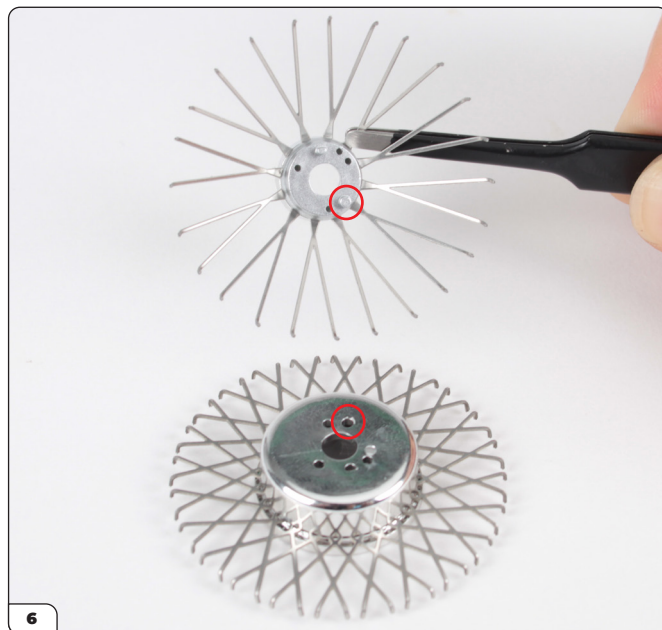

Turn the inner spokes over, then fit the outer spokes on top using the larger pin on the wheel hub front as a guide.



The ends of the outer spokes should sit in the 'V' of the inner spoke ends once in place.



Place the spoke retainer ring (2VB-H) over the assembly in the orientation shown.

## Stage 002VB: Build the First Wheel Rim (Easy-Build)



Align the retainer ring so that the outer spokes fit into the recesses around the edge (inset). Check all the spokes are in place.

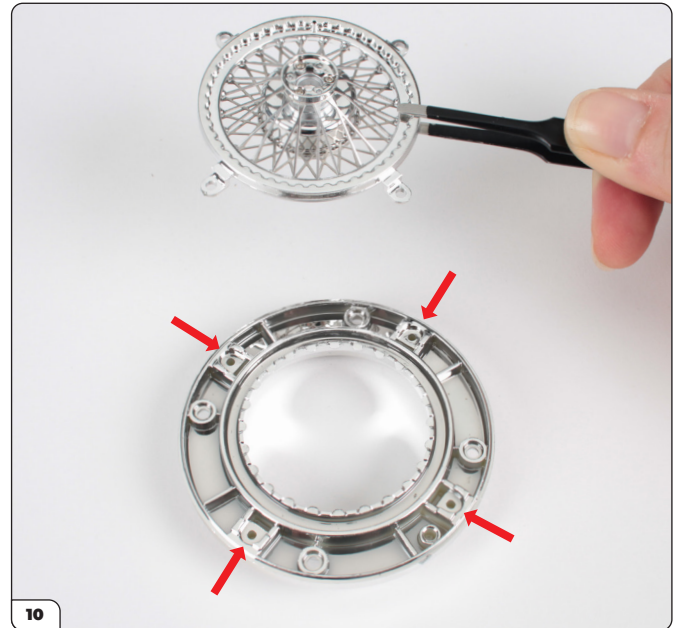

Fit the four tabs on the retainer ring into the recesses on the inner wheel rim (2VB-B).

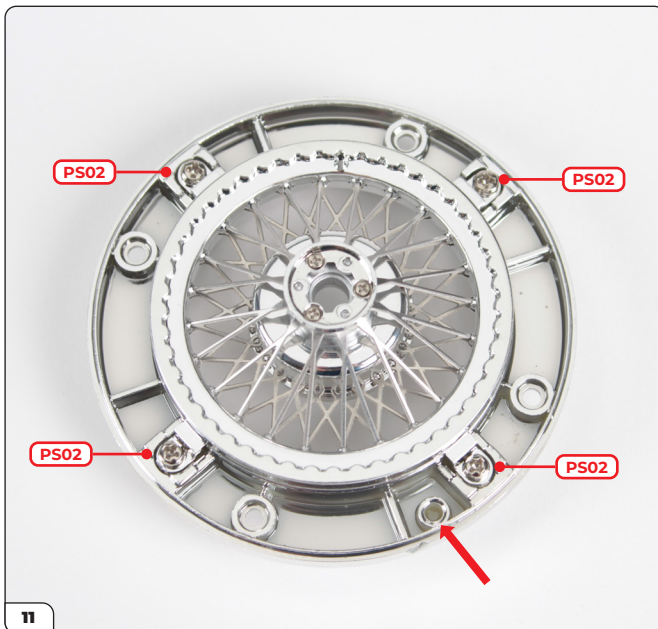

Secure using 4x PS02 screws. Note the indicated hole for the pin in the next step (arrow).

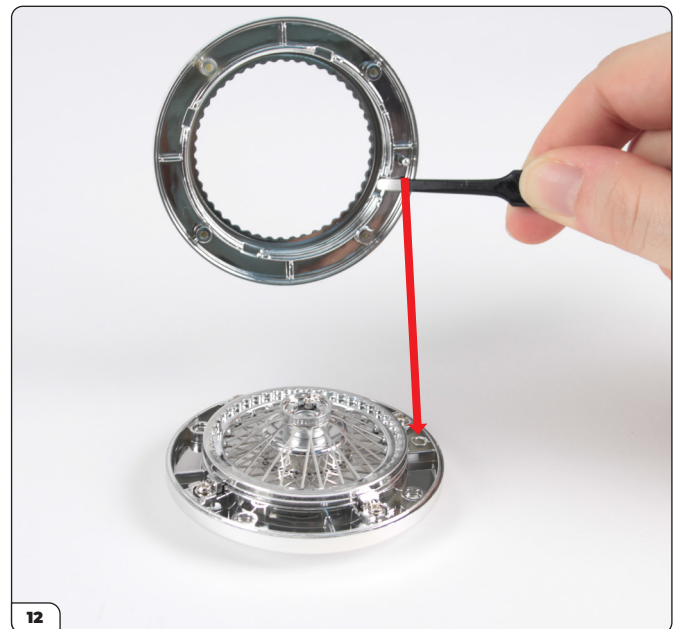

Fit the outer wheel rim (2VB-E) in place using the pin as a guide.

## Stage 002VB: Build the First Wheel Rim (Easy-Build)

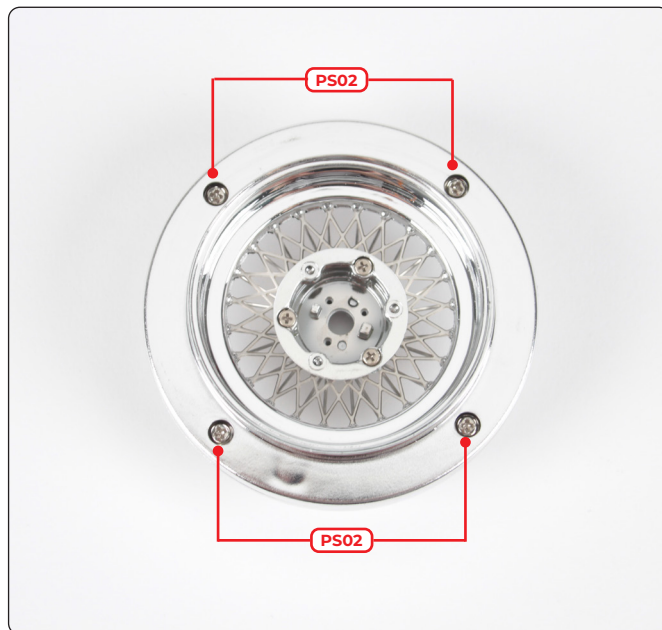

Press firmly around the edges, then turn the assembly over and secure using 4x PS02 screws.

STAGE COMPLETE





## Stage 002: Building the Outer Wheel Rim (Regular)

Use this stage for starting to build the regular version of the wheel rims for the DB5. Go to Stage 004 if you are following the easy-build instructions.

Watch our video for extra guidance here: <https://youtu.be/iJAt2nvWEQw>



### STAGE 002 PARTS LIST

Name
2-A Spoke retainer ring
2-B Wheel centre
2-C Outer wheel rim
2-D Jig
2-E Spokes x24
2-E Spokes x24
PS01 screws x5
Tweezers



## Stage 002: Building the Outer Wheel Rim (Regular)

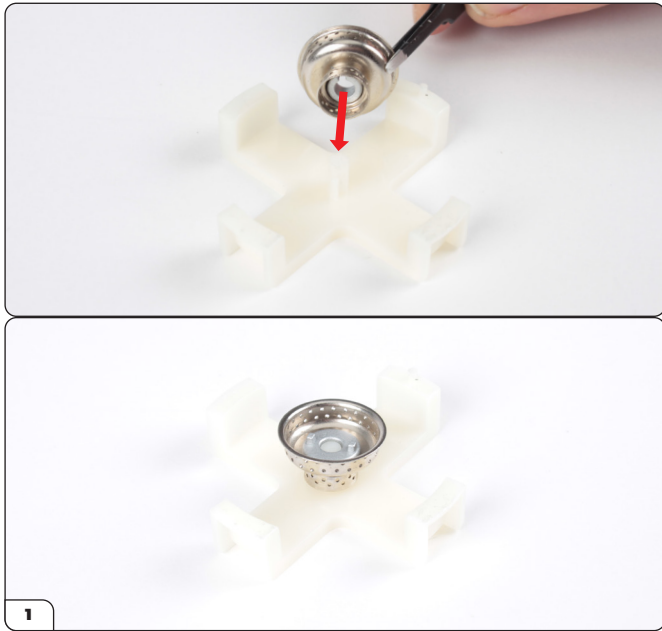

Align the shaped hole in the wheel centre (2-B) with the post on the jig (2-D) then fit it in place.

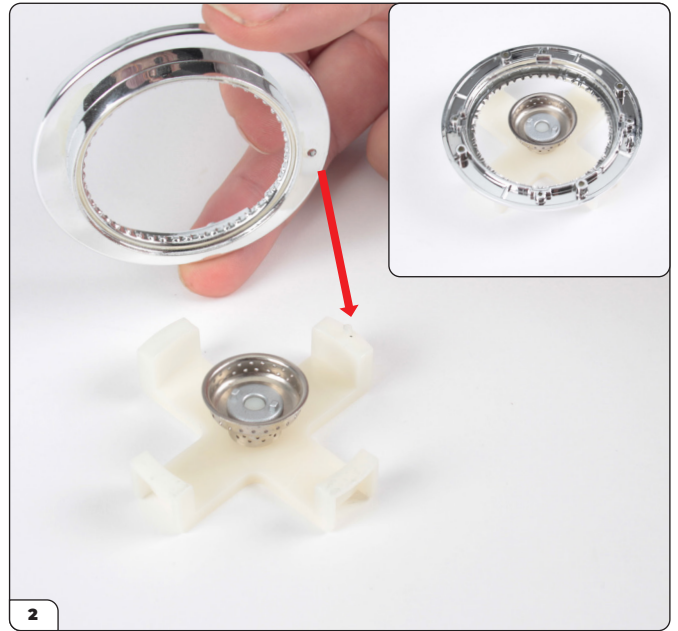

Fit the outer wheel rim (2-C) onto the jig, using the pin as a guide. Press firmly to lock the rim in position.

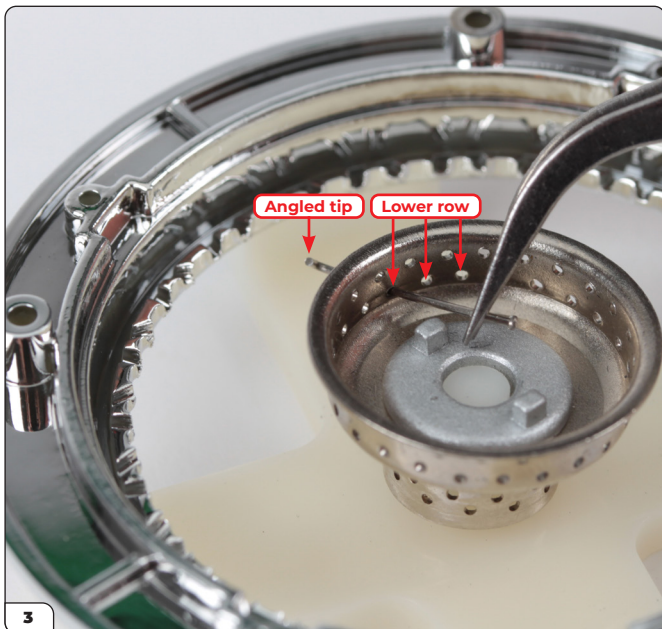

Open a bag of spokes (2-E) and thread the angled tip through one of the holes of the lower row.

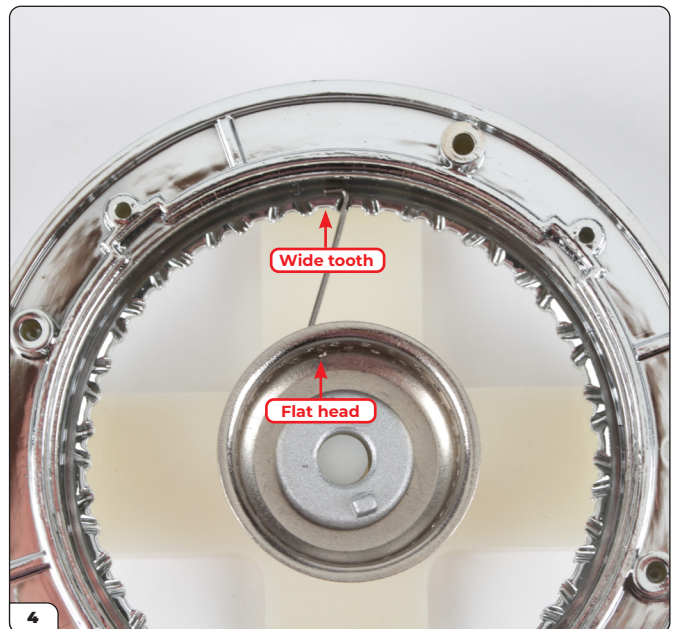

Pull the spoke through until the flat head reaches the hole, then hook the tip around the nearest wide tooth that gives a comfortable fit. The tip must face the wide tooth, as shown.



## Stage 002: Building the Outer Wheel Rim (Regular)

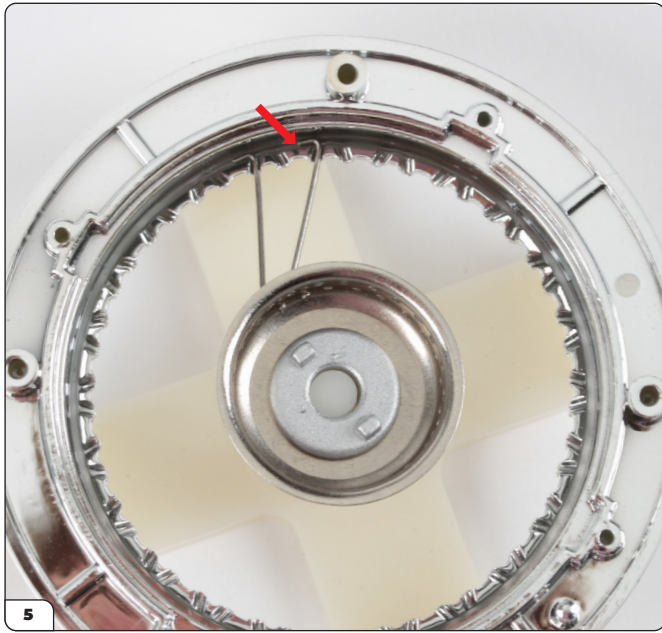

Thread another spoke through the next lower row hole and hook the tip around the next wide tooth (arrow). As you fit the remaining spokes, you can gently adjust the tension by twisting the wheel centre with your flat of your thumb.



Continue until all 24 spokes are in position.

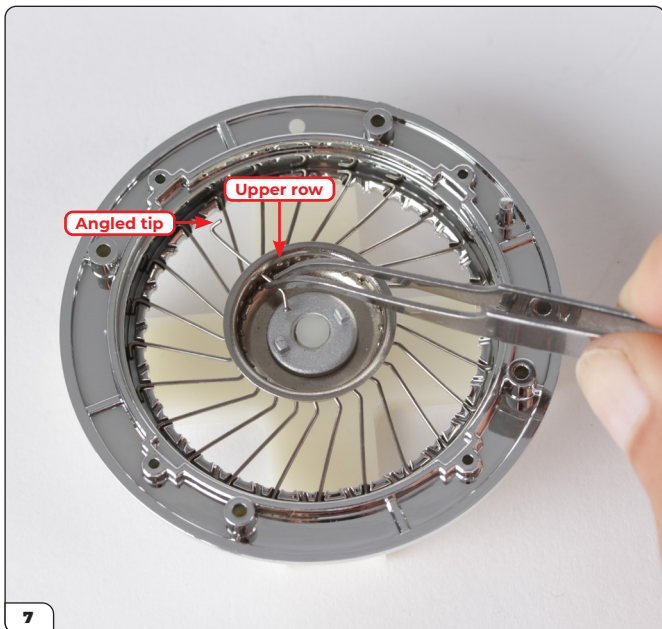

Open the remaining bag of spokes (2-E) and thread the angled tip through one of the holes in the upper row.

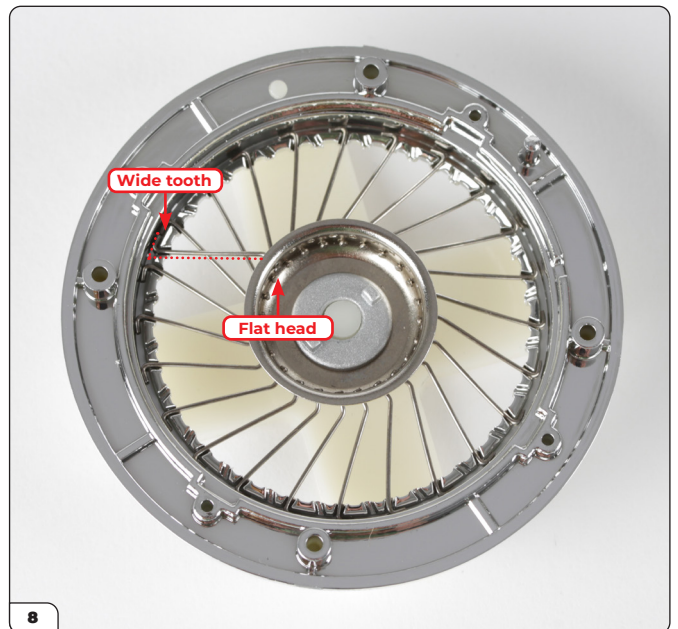

Pull the spoke through until the flat head reaches the hole, then hook the tip around the nearest wide tooth that gives a comfortable fit, facing the tip of the lower row spoke. While threading, some of the other spokes may be knocked out of position. You can wait until both rows have been threaded before correcting any tips.

## Stage 002: Building the Outer Wheel Rim (Regular)



Thread another spoke through the next upper row hole and hook the tip around the next wide tooth (arrow). Note the spokes create a diamond shape, highlighted in the image.

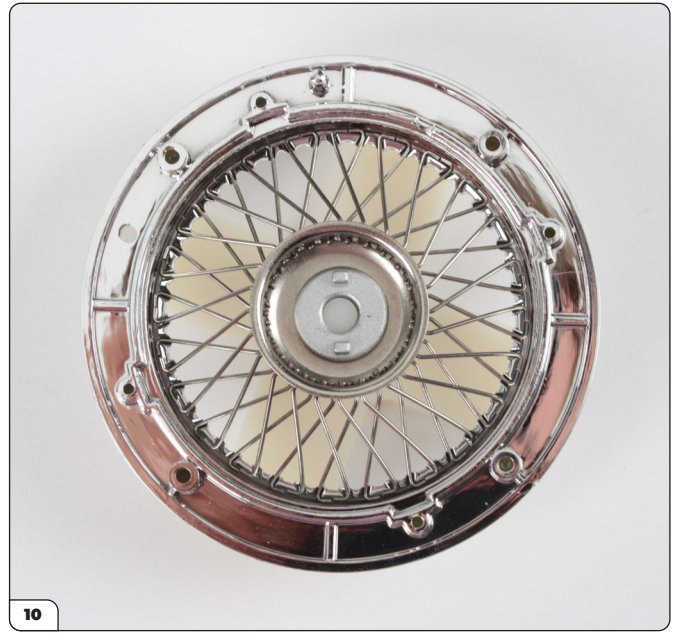

Continue in sequence until all spokes have been fitted, then carefully check each wide tooth to ensure the spokes are in the correct position.

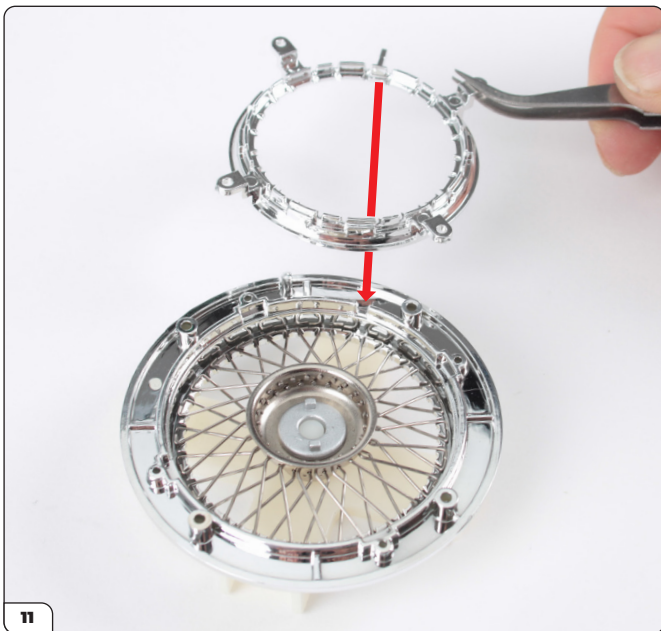

Fit the spoke retainer ring (2-A), using the protruding tab as a guide.

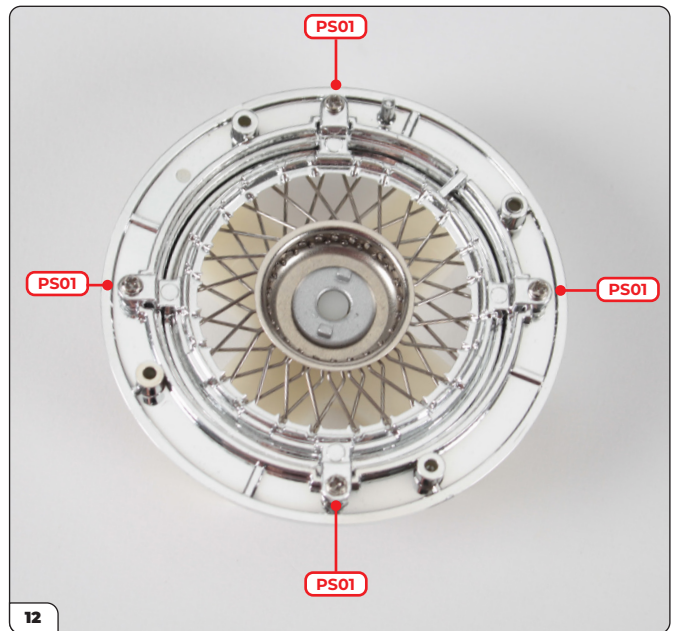

Check the spokes are in place, then secure the ring using 4x PS01 screws. To continue building, go to Stage 003.



## Stage 002: Building the Outer Wheel Rim (Regular)

STAGE COMPLETE



## Stage 003: Building the Inner Wheel Rim (Regular)

You'll continue to assemble the wheel by building the inner rim and its spokes then fitting it to the outer rim.



### STAGE 003 PARTS LIST

Name
3-A Inner wheel rim
3-B Spacer ring
3-C Spokes type A x12
3-D Spokes type B x12
PS02 screws x5

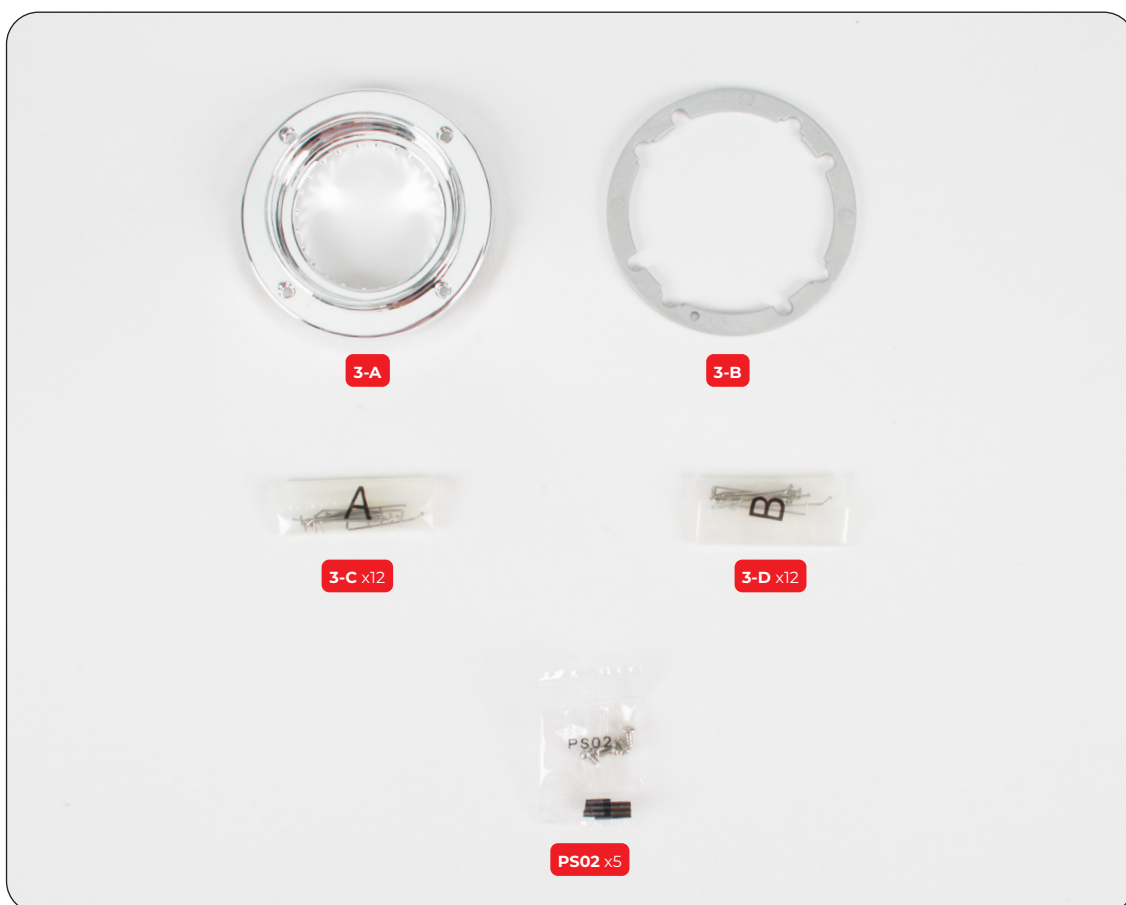

## Stage 003: Building the Inner Wheel Rim (Regular)

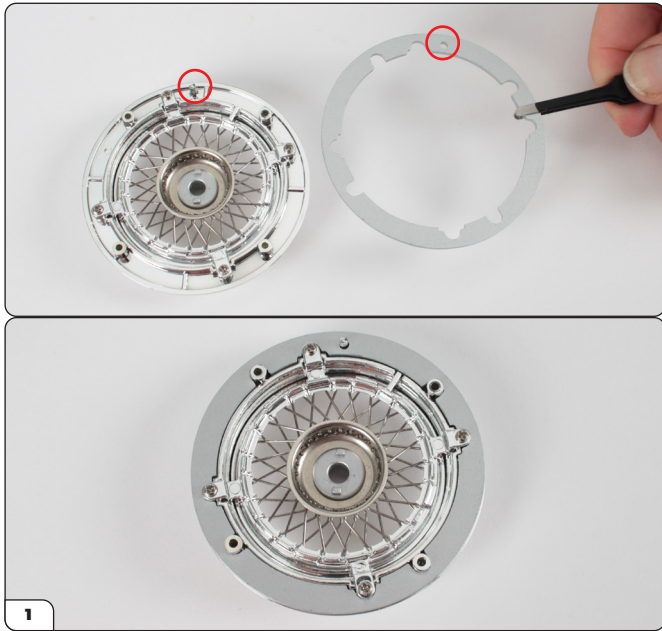

Align the spacer ring (3-B) with the outer wheel rim assembly (Stage 002) using the hole and pin (circled) as a guide. Fit the ring in place.

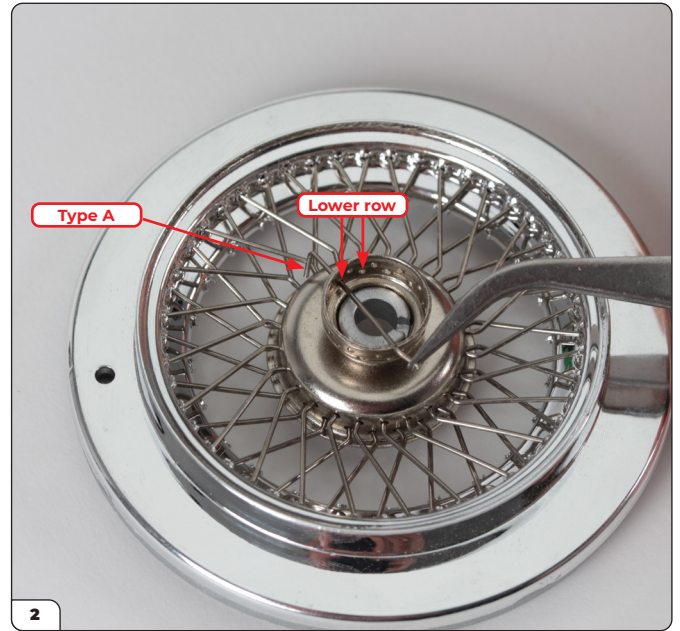

Turn the assembly over and push the tip of a type A spoke (3-C) through one of the holes in the lower row.



Pull the spoke through and guide the tip into the diamond shape to the left and out through to the opposite side.

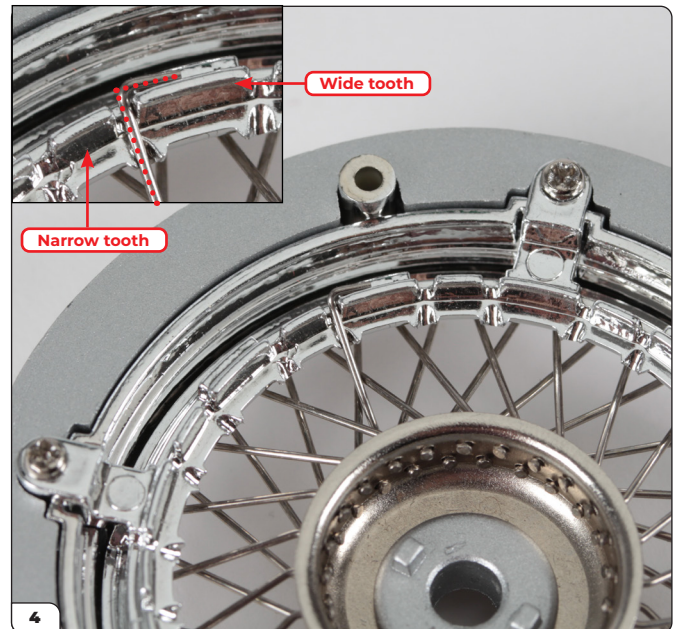

Turn the assembly over and fit the tip of the spoke. **It should hook around a wide tooth as shown.** If it aligns with a narrow tooth, thread the spoke through the next diamond along. This is very important. **Please ensure the spoke is fitted around a wide tooth.**



## Stage 003: Building the Inner Wheel Rim (Regular)



Once you are happy with the fit of the first spoke, thread another type A into the next lower hole and through the diamond two-along from the first, as highlighted in the image. At this stage, the tips can be left loose on the opposite side.



Continue to thread type A spokes around the lower row, pushing the tip through alternating diamonds as indicated. Continue to leave the ends loose for now, they do not need fitting onto the wide teeth yet.



Now take a type B spoke (3-D) and thread it through a hole of the upper row. Cross it over the lower row spoke to its left (circled) and guide the tip to the empty diamond without a spoke through it (highlighted).

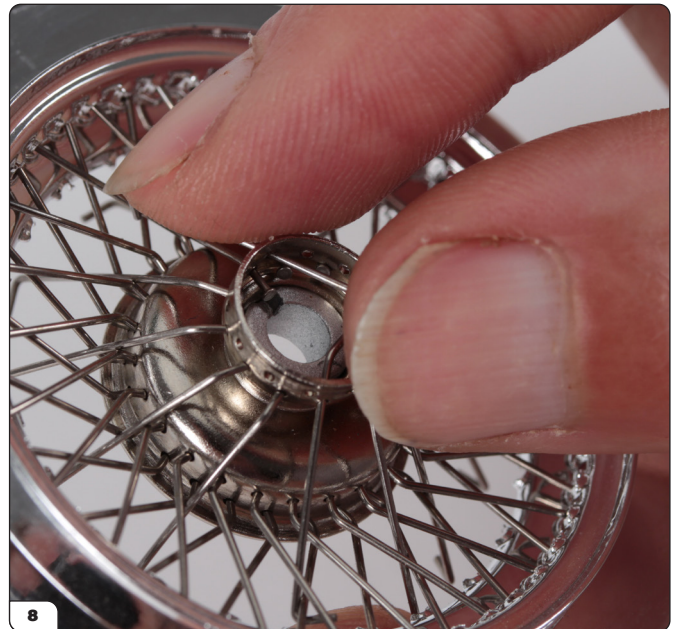

Press the tip through the diamond with your forefinger while pushing the spoke into position with your thumb as shown.



## Stage 003: Building the Inner Wheel Rim (Regular)

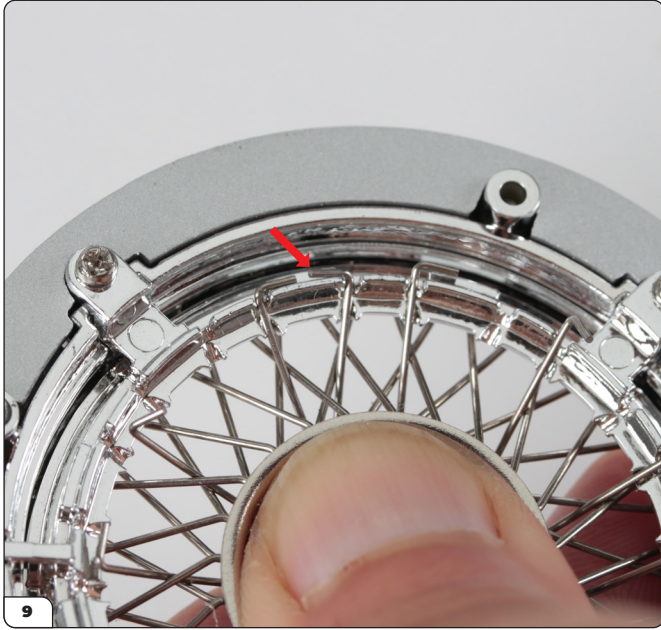

9 Turn the assembly over and check the tip fits over a wide tooth to face one of the lower row spokes.



10 Turn back over and thread another type B spoke into the next upper hole along, crossing it over the type A to its left and into the next empty diamond to the left.

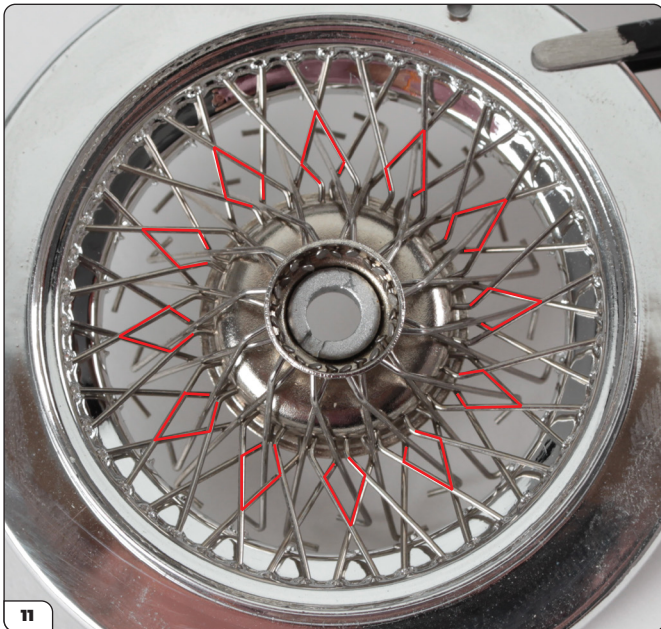

11 Continue to thread type B spokes through, crossing over the type A and through the next empty diamond in the same way.



12 Once you are happy all the spokes are fitted correctly, they can be fitted to the wide teeth. Start by pushing a piece of tissue paper into the wheel centre to hold the spokes in place.



## Stage 003: Building the Inner Wheel Rim (Regular)

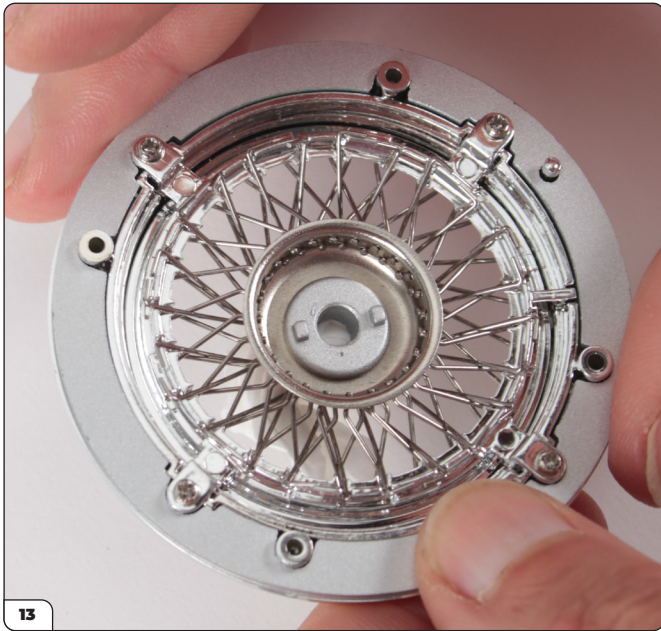

Keeping the tissue in place to hold the spokes, turn the assembly over. The tips of the spokes should now fall naturally towards the teeth.

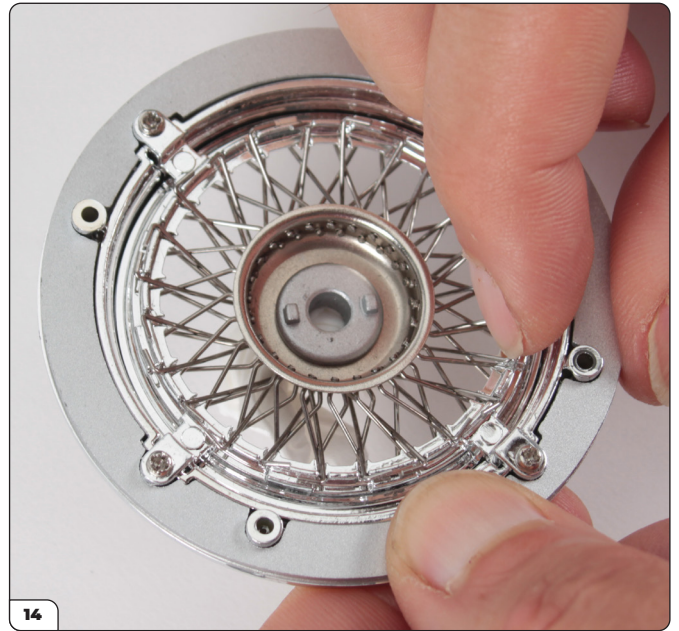

Gently brush the spokes with your finger to hook them over the wide teeth around the edge. The tension can be adjusted by gently pushing the soft part of your thumb into the centre and carefully twisting.

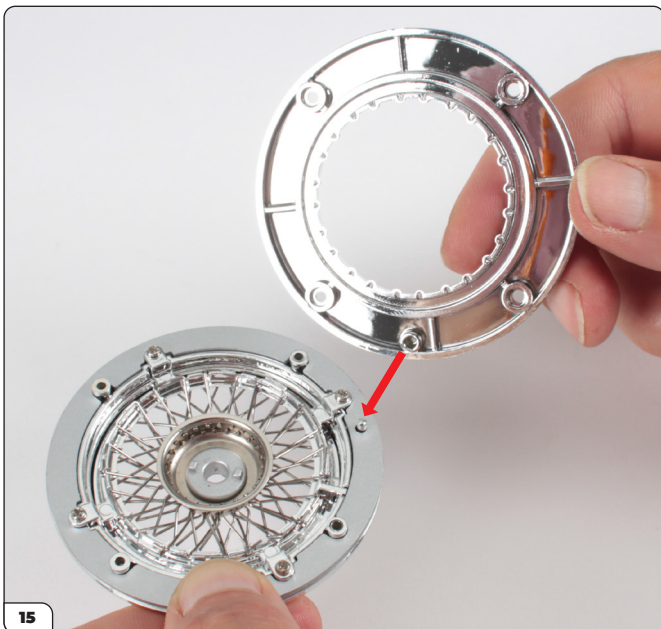

Align the inner wheel rim (3-A) with the assembly using the hole and pin as a guide.

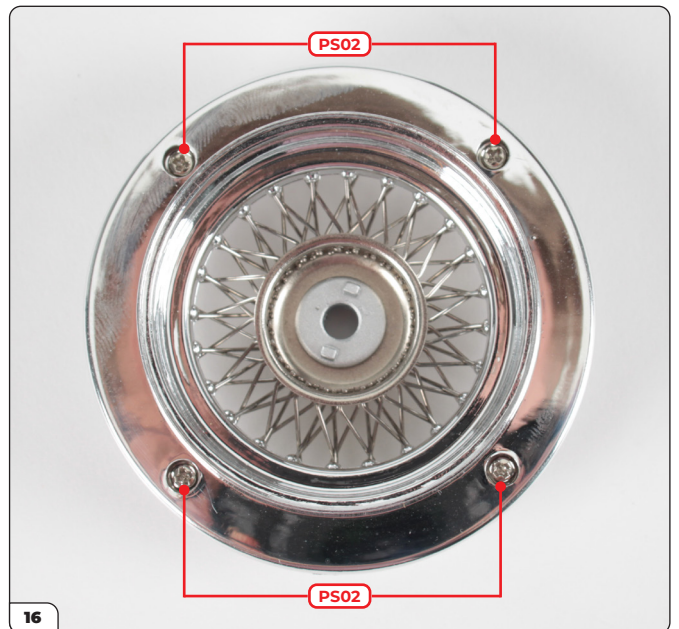

Press the inner rim in place, making sure the spokes stay in position, then secure using 4x PS02 screws.

## Stage 003: Building the Inner Wheel Rim (Regular)

STAGE COMPLETE



## Stage 004: Fitting the Tyre

Now you'll fit the tyre around the wheel rim.



### STAGE 004 PARTS LIST

Name
4-A Tyre
4-B Hub cap

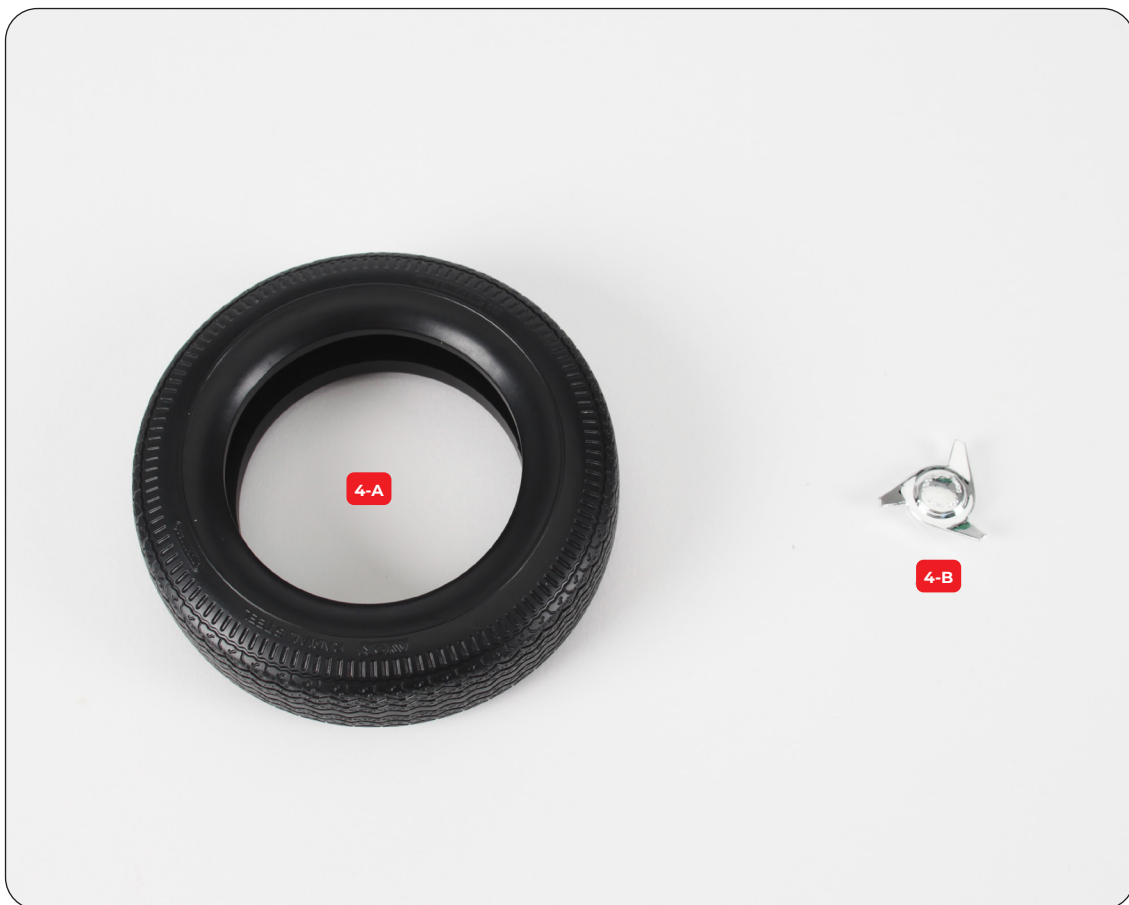



## Stage 004: Fitting the Tyre



Carefully place the tyre (4-A) in a bowl of hot water to soften it. Take care not to splash hot water when placing the tyre in the bowl.



After 1-2 minutes, remove the tyre from the water using tweezers to avoid burning your fingers. Dry with a cloth.



Fit your wheel rim (from stage 002VB or stage 003) into the tyre while it is still flexible. Press the rim into the tyre, then work your way around pulling the tyre over the rim.



Fit the hub cap (4-B) onto the wheel centre. The magnet will hold it in place.

## Stage 004: Fitting the Tyre

---

STAGE COMPLETE



## Stage 005: Building the Right Door

In this stage you'll begin building the right door by fitting the hinge mount, window and door handle.



### STAGE 005 PARTS LIST

Name
5-A Right door
5-B Right window
5-C Door hinge plate
5-D Door hinge mount
5-E Right door handle
DS02 screws x4
PS21 screws x2





## Stage 005: Building the Right Door

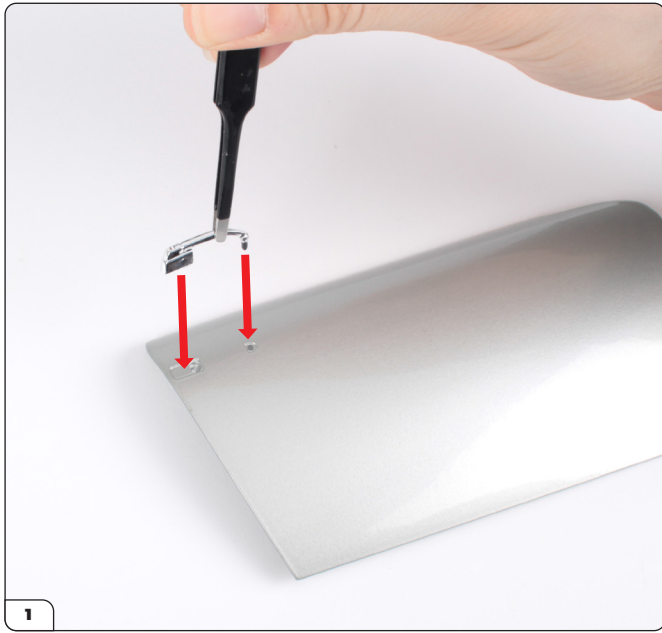

Now you're working on the painted body parts again, it's a good idea to have your soft cloth ready to protect the beautiful paintwork. Start by fitting the right door handle (5-E) into the shaped holes in the door (5-A).



With the soft cloth on your work surface, turn the door over and secure the handle in place using a PS21 screw.



Fit the right window (5-B) onto the screw posts on the door.

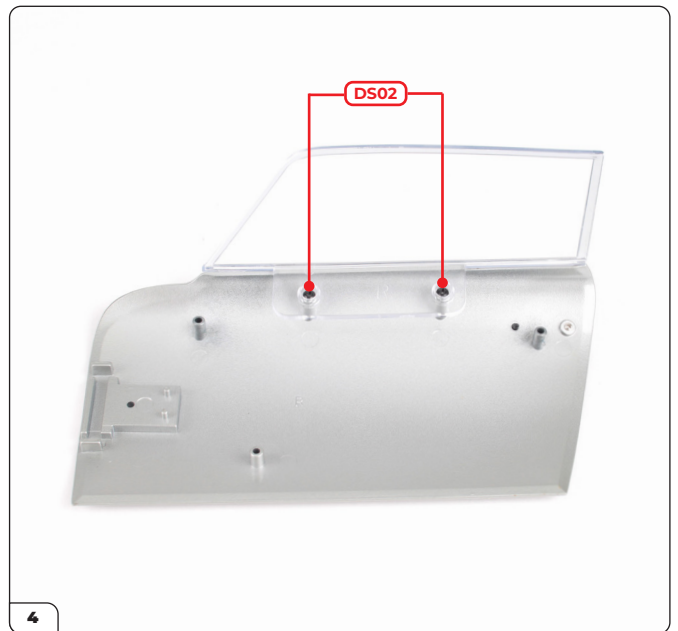

Secure using 2x DS02 screws.

## Stage 005: Building the Right Door

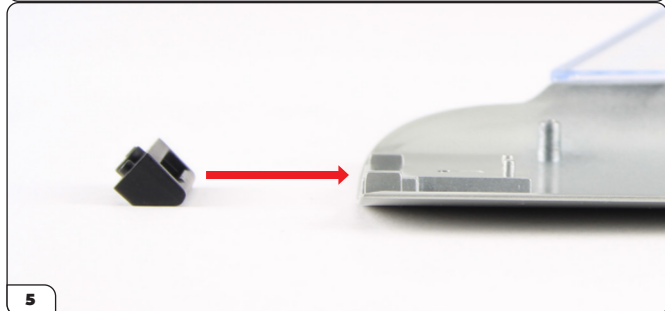
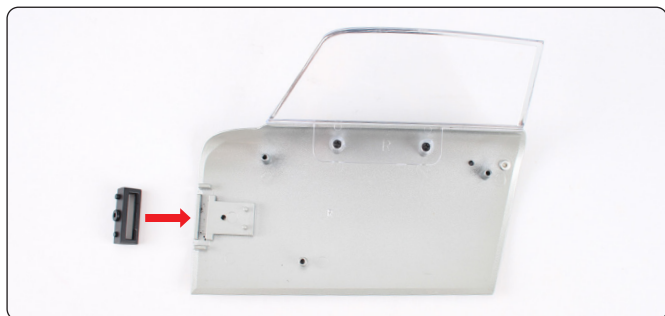

Place the door hinge mount (5-D) into the recess. Make sure the mount is oriented as shown.

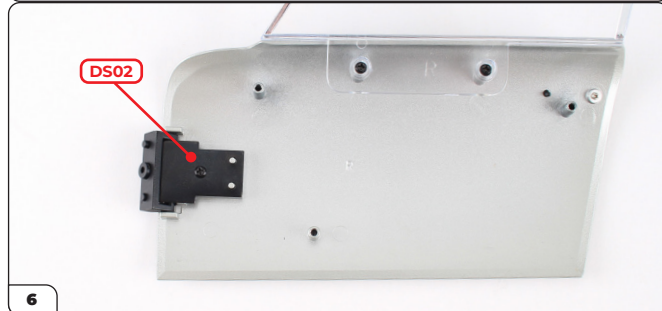
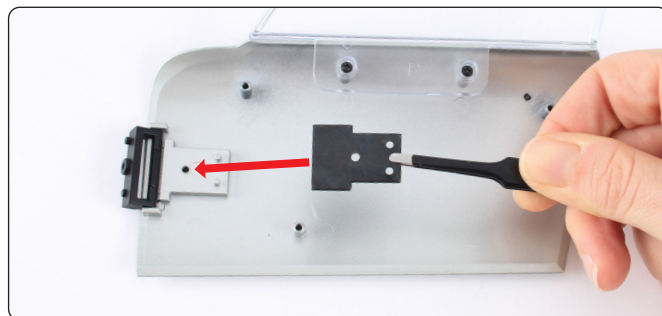

Fit the plate (5-C) onto the two silver pins then secure it using a DS02 screw.

**STAGE COMPLETE**



## Stage 006: Assembling the Right Door Panel

In this stage you'll prepare the right door panel by attaching the armrest and door handle.



### STAGE 006 PARTS LIST

Name
6-A Right door panel
6-B Right door armrest
6-C Right door handle
PS05 screws x3
PS12 screws x2

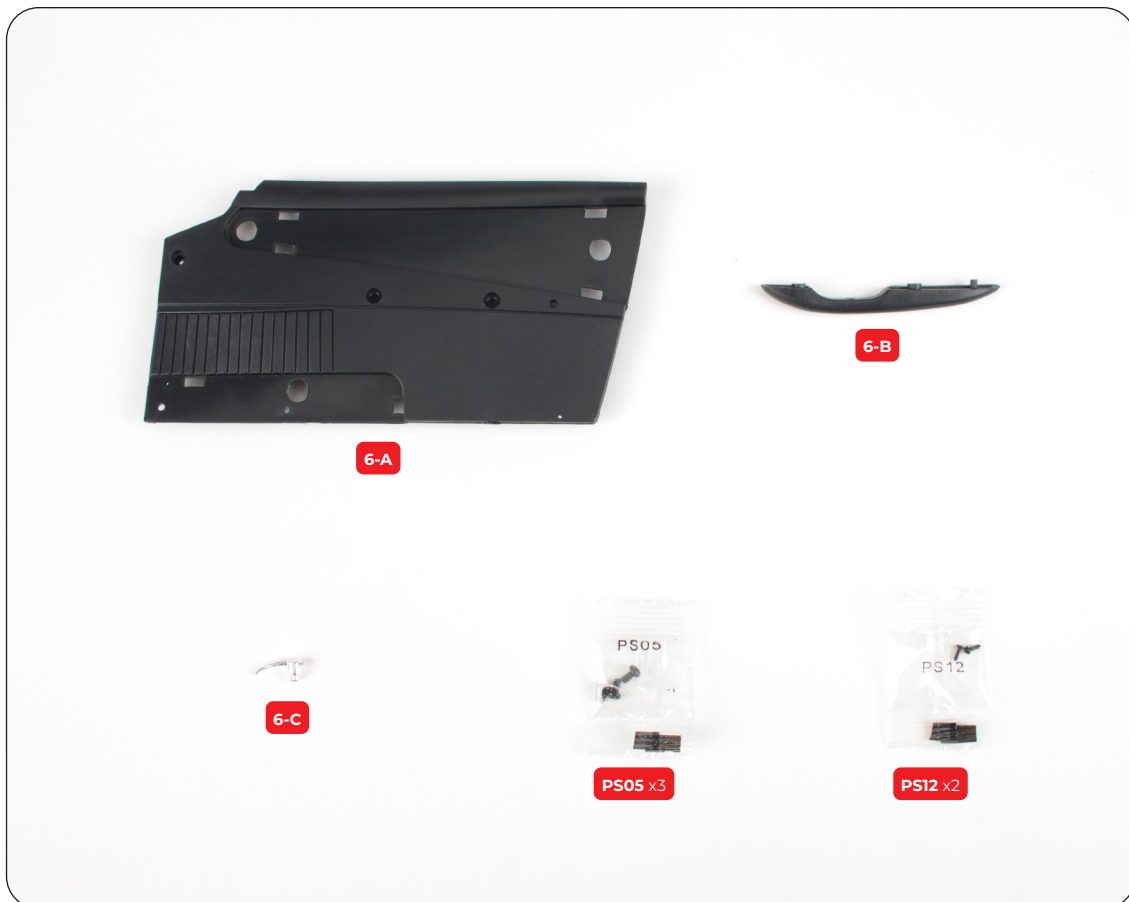



## Stage 006: Assembling the Right Door Panel



Fit the armrest (6-B) into the right door panel (6-A).

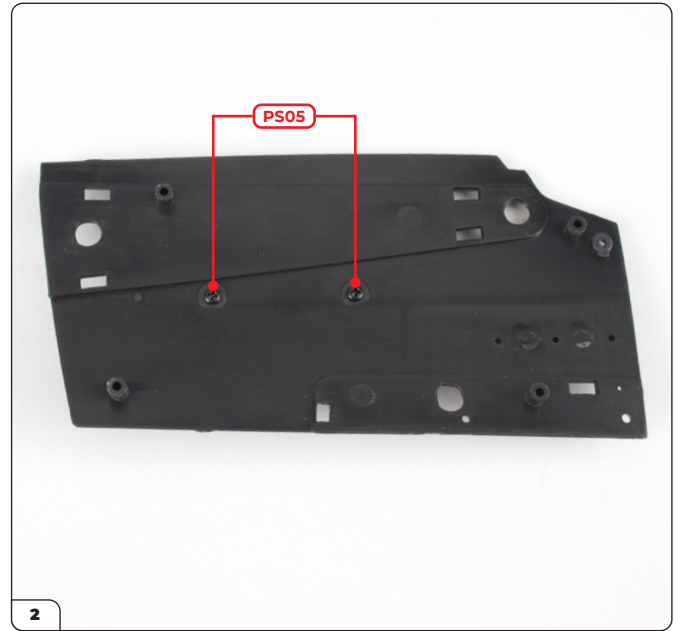

Turn the panel over and secure the armrest using 2x PS05 screws.



Fit the door handle (6-C) into the shaped hole on the door panel.



Secure from the reverse side using a PS12 screw.

## Stage 006: Assembling the Right Door Panel

---

STAGE COMPLETE



# Stage 007: Mounting the Right Door Panel and Trim

To finish building the right door you'll attach the inside door panel, mount the trims, and then attach it to the right door assembly.



## STAGE 007 PARTS LIST

Name
7-A Right door inside panel
7-B Right door L-shaped trim
7-C Right door bottom trim
7-D Right door top trim
DS02 screws x4
PS05 screws x5





## Stage 007: Mounting the Right Door Panel and Trim



Align the right door inside panel (7-A) and the panel assembly (stage 006) as shown.



Press them together.

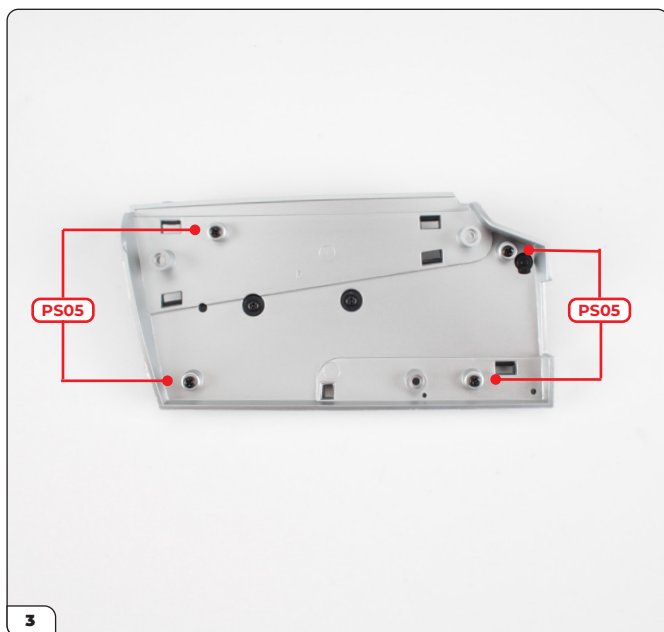

Turn the assembly over and secure using 4x PS05 screws.

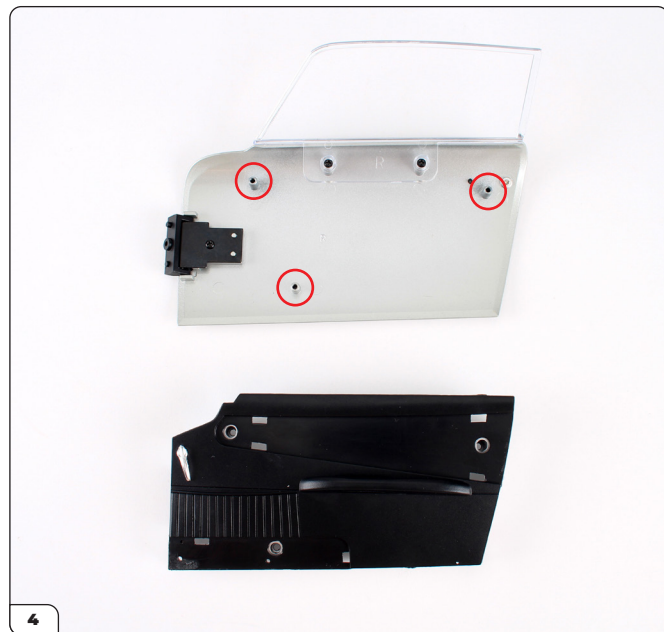

Fit the panel assembly onto the right door (stage 005) by pushing the holes over the posts (circled). Secure the panels using 3x DS02 screws.

## Stage 007: Mounting the Right Door Panel and Trim

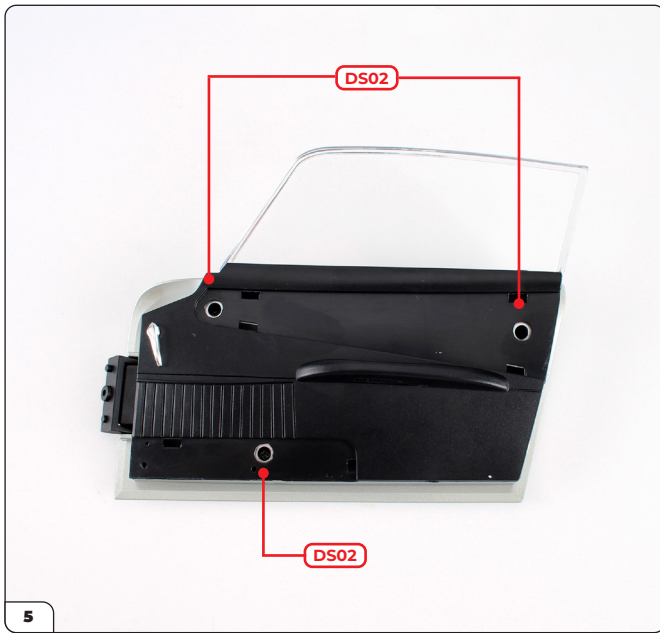

Secure the panels using 3x DS02 screws.

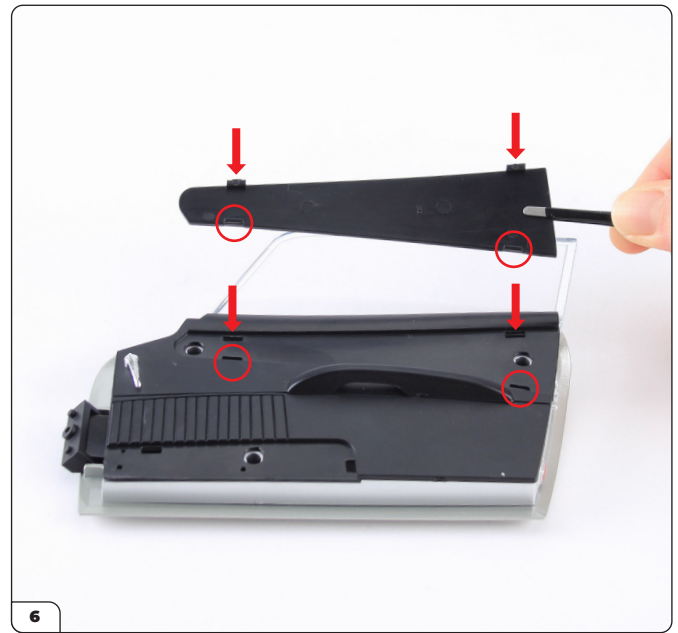

Align the top trim (7-D) with the recess in the door panel as shown. First fit the two tabs into the lower openings (circled), then push down firmly on the other tabs to press them into the two upper openings (arrows).



If it is difficult to press the tabs in place, carefully remove any excess paint or plastic to get a good fit.

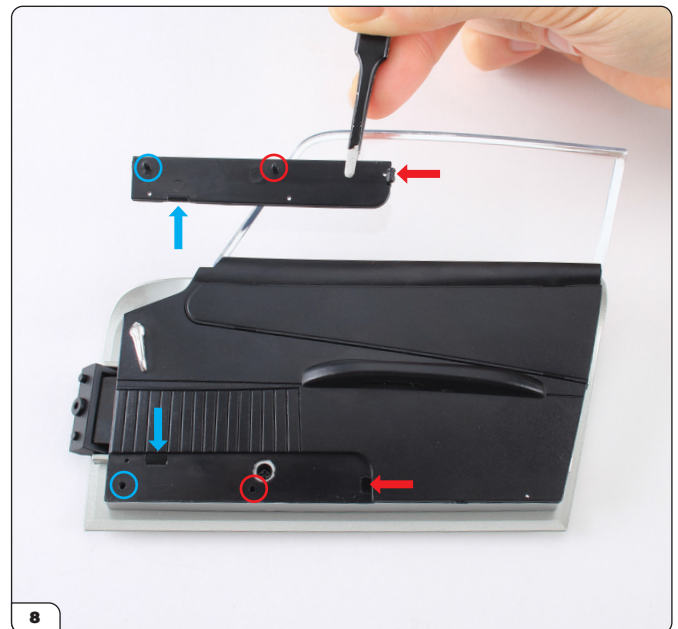

To fit the bottom trim (7-C), first push the right tab into the corresponding opening (red arrows). Then half-press the middle pin into its hole (red circles). Pull the other tab toward its opening (blue arrows) while guiding the last pin to its hole (blue circle). You may need to gently bend the trim and the fitting part-way until all are in position.

## Stage 007: Mounting the Right Door Panel and Trim



Press the bottom trim firmly into place, then align the L-shaped trim (7-B) with the three holes.



Push the trim firmly in place until it fits flush.

